

# EPSON

6-Axis Robots

## *C8 series*

MANIPULATOR MANUAL

Rev.13

EM208R4413F



6-Axis Robots

# *C8 series Manipulator Manual*

Rev. 13

Copyright © 2015-2020 SEIKO EPSON CORPORATION. All rights reserved.

## FOREWORD

Thank you for purchasing our robot products.

This manual contains the information necessary for the correct use of the manipulator.

Please carefully read this manual and other related manuals before installing the robot system.

Keep this manual handy for easy access at all times.

## WARRANTY

The robot and its optional parts are shipped to our customers only after being subjected to the strictest quality controls, tests, and inspections to certify its compliance with our high performance standards.

Product malfunctions resulting from normal handling or operation will be repaired free of charge during the normal warranty period. (Please contact the supplier of your region for warranty period information.)

However, customers will be charged for repairs in the following cases (even if they occur during the warranty period):

1. Damage or malfunction caused by improper use which is not described in the manual, or careless use.
2. Malfunctions caused by customers' unauthorized disassembly.
3. Damage due to improper adjustments or unauthorized repair attempts.
4. Damage caused by natural disasters such as earthquake, flood, etc.

Warnings, Cautions, Usage:

1. If the robot or associated equipment is used outside of the usage conditions and product specifications described in the manuals, this warranty is void.
2. If you do not follow the WARNINGS and CAUTIONS in this manual, we cannot be responsible for any malfunction or accident, even if the result is injury or death.
3. We cannot foresee all possible dangers and consequences. Therefore, this manual cannot warn the user of all possible hazards.



## TRADEMARKS

Microsoft, Windows, and Windows logo are either registered trademarks or trademarks of Microsoft Corporation in the United States and/or other countries. Other brand and product names are trademarks or registered trademarks of the respective holders.

## NOTICE

No part of this manual may be copied or reproduced without authorization.

The contents of this manual are subject to change without notice.

Please notify us if you should find any errors in this manual or if you have any comments regarding its contents.

## MANUFACTURER

**SEIKO EPSON CORPORATION**

## CONTACT INFORMATION

Contact information is described in “SUPPLIERS” in the first pages of the following manual:

*Robot System Safety and Installation Read this manual first*

## Regarding battery disposal



The crossed out wheeled bin label that can be found on your product indicates that this product and incorporated batteries should not be disposed of via the normal household waste stream. To prevent possible harm to the environment or human health please separate this product and its batteries from other waste streams to ensure that it can be recycled in an environmentally sound manner. For more details on available collection facilities please contact your local government office or the retailer where you purchased this product. Use of the chemical symbols Pb, Cd or Hg indicates if these metals are used in the battery.

This information only applies to customers in the European Union, according to DIRECTIVE 2006/66/EC OF THE EUROPEAN PARLIAMENT AND OF THE COUNCIL OF 6 September 2006 on batteries and accumulators and waste batteries and accumulators and repealing Directive 91/157/EEC and legislation transposing and implementing it into the various national legal systems.

For other countries, please contact your local government to investigate the possibility of recycling your product.

The battery removal/replacement procedure is described in the following manuals:

Robot Controller manual / Manipulator manual (Maintenance section)

## Before Reading This Manual

This section describes what you should know before reading this manual.

### Structure of Control System

C8 Manipulators can be used with the following combinations of Controllers and software.

Controller : RC700-A

Software : EPSON RC+ 7.0 Ver.7.1.3 or later (C8XL)  
EPSON RC+ 7.0 Ver.7.1.4 or later (C8, C8L)  
EPSON RC+ 7.0 Ver.7.2.0 or later (wall mounting)

### Setting by Software

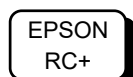

This manual contains setup procedures using the software.

Those sections are indicated by the symbol on the left.

### Turning ON/OFF Controller

When you see the instruction “Turn ON/OFF the Controller” in this manual, be sure to turn ON/OFF all the hardware components.

### Photos and Illustrations Used in This Manual

The appearance of some parts may differ from those on an actual product depending on when it was shipped or the specifications. The procedures themselves, however, are accurate.



## Setup & Operation

<b>1. Safety</b>	<b>3</b>
1.1 Conventions.....	3
1.2 Design and Installation Safety.....	4
1.3 Operation Safety .....	5
1.4 Emergency Stop.....	7
1.5 How to Move Arms with the Electromagnetic Brake .....	9
1.5.1 Moving the Arm using the brake release unit.....	10
1.5.2 Moving the Arm using the software .....	10
1.6 Precaution for Operation in Low Power Status.....	10
1.7 Warning Labels.....	11
<b>2. Specifications</b>	<b>13</b>
2.1 Features of Manipulators .....	13
2.2 Model Number .....	14
2.3 Part Names and Motion Range of Each Arm.....	15
2.4 Outer Dimensions.....	17
2.4.1 C8-A701*** (C8).....	17
2.4.2 C8-A901*** (C8L).....	18
2.4.3 C8-A1401*** (C8XL).....	19
2.5 Standard Motion Range .....	20
2.5.1 C8-A701*** (C8).....	20
2.5.2 C8-A901*** (C8L).....	21
2.5.3 C8-A1401*** (C8XL).....	22
2.6 Specifications .....	23
2.6.1 Specifications table .....	23
2.6.2 Option .....	27
2.7 How to Set the Model.....	28
<b>3. Environment and Installation</b>	<b>29</b>
3.1 Environmental Conditions .....	29
3.2 Unpacking, Transportation, and Relocation.....	31
3.3 Mounting Dimensions.....	34
3.3.1 Cable Backward Model .....	34
3.3.2 Cable Downward Model .....	36
3.4 Installation .....	37
3.5 Connecting the Cables .....	40
3.6 User Wires and Pneumatic Tubes.....	42
Electrical wires .....	43
Pneumatic tubes .....	44
3.7 Checking the Basic orientation.....	45

<b>4. End Effectors</b>	<b>46</b>
4.1 Attaching an End Effector .....	46
4.2 Attaching Camera and Air Valves .....	46
4.3 WEIGHT and INERTIA Settings.....	48
4.3.1 WEIGHT setting .....	50
4.3.2 INERTIA setting.....	54
4.4 Precautions for Auto Acceleration/Deceleration .....	59
<b>5. Motion Range</b>	<b>60</b>
5.1 Motion Range Setting by Pulse Range (for Each Joint).....	60
5.1.1 Max. Pulse Range of Joint #1 .....	61
5.1.2 Max. Pulse Range of Joint #2 .....	61
5.1.3 Max. Pulse Range of Joint #3 .....	62
5.1.4 Max. Pulse Range of Joint #4 .....	62
5.1.5 Max. Pulse Range of Joint #5 .....	63
5.1.6 Max. Pulse Range of Joint #6 .....	63
5.2 Motion Range Setting by Mechanical Stops.....	64
5.2.1 Motion Range Setting of Joint #1.....	64
5.2.2 Motion Range Setting of Joint #2.....	65
5.2.3 Motion Range Setting of Joint #3.....	66
5.3 Restriction of Manipulator Operation by Joint Angle Combination .....	67
5.4 Coordinate System.....	71
5.5 Changing the Robot .....	72
5.6 Setting the Cartesian (Rectangular) Range in the XY Coordinate System of the Manipulator .....	73
<b>6. Options</b>	<b>74</b>
6.1 Brake Release Unit .....	74
Mount the brake release unit .....	76
Remove the brake release unit.....	76
How to use the brake release unit.....	77
6.2 Camera Plate Unit.....	78
6.3 Tool Adapter (ISO Flange) .....	80
6.4 Adjustable Mechanical Stops.....	81
6.5 User Wires and Pneumatic Tubes .....	82

# Maintenance

<b>1. Safety Maintenance</b>	<b>85</b>
<b>2. General Maintenance</b>	<b>86</b>
2.1 Maintenance Inspection .....	86
2.1.1 Schedule for Maintenance Inspection .....	86
2.1.2 Inspection Point .....	87
2.2 Overhaul (Parts Replacement).....	89
2.3 Greasing .....	91
2.3.1 Joint #1 Reduction Gear Unit (Table Top Mounting) .....	93
2.3.2 Joint #1 Reduction Gear Unit (Ceiling Mounting, Wall mounting) .....	94
2.3.3 Joint #2 Reduction Gear Unit .....	95
2.3.4 Joint #3 Reduction Gear Unit .....	96
2.3.5 Joint #4 Reduction Gear Unit .....	97
2.3.6 Joint #5 Reduction Gear Unit .....	98
2.3.7 Joint #6 Reduction Gear Unit .....	99
2.3.8 Joint #6 Bevel Gear .....	100
2.4 Tightening Hexagon Socket Head Bolts .....	101
2.5 Layout of Maintenance Parts .....	102
<b>3. Covers</b>	<b>103</b>
3.1 Arm #1 Center Cover .....	106
3.2 Arm #1 Side Cover .....	107
3.3 Arm #2 Side Cover .....	109
3.4 Arm #3 Cover .....	110
3.5 Arm #3 Maintenance Cover .....	111
3.6 Arm #4 Side Cover .....	113
3.7 Arm #4 Maintenance Cover (C8XL only) .....	115
3.8 Arm #4 D-sub Attachment .....	117
3.9 Base Cover .....	118
3.9.1 M/C Cable Backward.....	118
3.9.2 M/C Cable Downward .....	119
3.10 Base Maintenance Cover.....	123
3.11 Connector Plate.....	125
3.11.1 M/C Cable Backward.....	125
3.11.2 M/C Cable Downward.....	129
3.12 Connector Sub Plate .....	130

<b>4. Cable Unit</b>	<b>132</b>
4.1 Replacing the Cable Unit .....	132
4.1.1 Replacing the Cable Unit (M/C Cable Backward).....	134
4.1.2 Replacing the Cable Unit (M/C Cable Downward) .....	164
4.2 Connector Pin Assignment.....	169
4.2.1 Signal Cable .....	169
4.2.2 Power Cable.....	172
4.2.3 User Cable .....	175
4.2.4 Color of Cables.....	175
<b>5. Joint #1</b>	<b>176</b>
5.1 M/C Cable Backward (Joint #1) .....	177
5.1.1 Joint #1 - Replacing the Motor (M/C Cable Backward) .....	177
5.1.2 Joint #1 - Replacing the Reduction Gear Unit (M/C Cable Backward).....	185
5.1.3 Joint #1 - Replacing the Timing Belt (M/C Cable Backward).....	192
5.1.4 Joint #1 - Replacing the Electromagnetic Brake (M/C Cable Backward).....	199
5.2 M/C Cable Downward (Joint #1).....	201
5.2.1 Joint #1 - Replacing the Motor (M/C Cable Downward) .....	201
5.2.2 Joint #1 - Replacing the Reduction Gear Unit (M/C Cable Downward).....	205
5.2.3 Joint #1 - Replacing the Timing Belt (M/C Cable Downward).....	208
5.2.4 Joint #1 - Replacing the Electromagnetic Brake (M/C Cable Downward).....	213
<b>6. Joint #2</b>	<b>216</b>
6.1 Joint #2 - Replacing the Motor .....	217
6.2 Joint #2- Replacing the Reduction Gear Unit .....	226
6.3 Joint #2 - Replacing the Timing Belt .....	233
6.4 Joint #2 - Replacing the Electromagnetic Brake.....	234
<b>7. Joint #3</b>	<b>235</b>
7.1 Joint #3 - Replacing the Motor .....	236
7.2 Joint #3 - Replacing the Reduction Gear Unit .....	244
7.3 Joint #3 - Replacing the Timing Belt .....	250
7.4 Joint #3 - Replacing the Electromagnetic Brake.....	251
<b>8. Joint #4</b>	<b>252</b>
8.1 Joint #4 - Replacing the Motor .....	253
8.2 Joint #4 - Replacing the Reduction Gear Unit .....	259
8.3 Joint #4 - Replacing the Timing Belt .....	266
8.4 Joint #4 - Replacing the Electromagnetic Brake.....	272



---

<b>9. Joint #5</b>	<b>273</b>
9.1 Joint #5 - Replacing the Motor .....	274
9.2 Joint #5 - Replacing the Reduction Gear Unit (Replacing the Joint #5, #6 Reduction Gear Unit Set) .....	281
9.3 Joint #5 - Replacing the Timing Belt .....	287
9.4 Joint #5 - Replacing the Electromagnetic Brake .....	288
<b>10. Joint #6</b>	<b>290</b>
10.1 Joint #6 - Replacing the Motor .....	291
10.2 Joint #6 - Replacing the Reduction Gear Unit (Replacing the Joints #5, #6 Reduction Gear Unit Set).....	297
10.3 Joint #6 - Replacing the Timing Belt .....	298
10.4 Joint #6 - Replacing the Electromagnetic Brake .....	299
<b>11. Replacing the Battery Unit</b>	<b>301</b>
11.1 Replacing the Battery Unit (Lithium Battery).....	303
11.2 Replacing the Battery Board .....	305
<b>12. Replacing the Control Board</b>	<b>308</b>
12.1 Replacing the Control Board 1 .....	309
12.2 Replacing the Control Board 2 .....	311
<b>13. Replacing the LED Lamp</b>	<b>313</b>
<b>14. Replacing the M/C Cable</b>	<b>315</b>
<b>15. Replacing the Fan</b>	<b>319</b>
<b>16. Calibration</b>	<b>321</b>
16.1 Overview.....	321
16.2 Calibration Procedure.....	324
<b>17. Maintenance Parts List</b>	<b>328</b>
<b>18. Option Parts List</b>	<b>332</b>



# Setup & Operation

This volume contains information for setup and operation of the Manipulators.  
Please read this volume thoroughly before setting up and operating the Manipulators.



# 1. Safety



Installation and transportation of the Manipulators and robotic equipment shall be performed by qualified personnel and should conform to all national and local codes.

Please read this manual and other related manuals before installing the robot system or before connecting cables.

Keep this manual handy for easy access at all times.

## 1.1 Conventions

Important safety considerations are indicated throughout the manual by the following symbols. Be sure to read the descriptions shown with each symbol.

 WARNING	This symbol indicates that a danger of possible serious injury or death exists if the associated instructions are not followed properly.
 WARNING	This symbol indicates that a danger of possible harm to people caused by electric shock exists if the associated instructions are not followed properly.
 CAUTION	This symbol indicates that a danger of possible harm to people or physical damage to equipment and facilities exists if the associated instructions are not followed properly.

## 1.2 Design and Installation Safety

Only trained personnel should design and install the robot system. Trained personnel are defined as those who have taken robot system training and maintenance training classes held by the manufacturer, dealers, or local representative companies, or those who understand the manuals thoroughly and have the same knowledge and skill level as those who have completed the training courses.

To ensure safety, a safeguard must be installed for the robot system. For details on the safeguard, refer to the *Installation and Design Precautions* in the *Safety* chapter of the EPSON RC+ User's Guide.



The following items are safety precautions for design personnel:

 WARNING	<ul style="list-style-type: none"> <li>■ Personnel who design and/or construct the robot system with this product must read the <i>Safety</i> chapter in the EPSON RC+ User's Guide. Designing and/or constructing the robot system without understanding the safety requirements is extremely hazardous, and may result in serious bodily injury and/or severe equipment damage to the robot system.</li> <li>■ The Manipulator and the Controller must be used within the environmental conditions described in their respective manuals. This product has been designed and manufactured strictly for use in a normal indoor environment. Using the product in an environment that exceeds the specified environmental conditions may not only shorten the life of the product but may also cause serious safety problems.</li> <li>■ The robot system must be used within the installation requirements described in the manuals. Using the robot system outside of the installation requirements may not only shorten the life of the product but also cause serious safety problems.</li> </ul>
---	---

Further precautions for installation are described in the chapter *Setup & Operation 3. Environment and Installation*. Please read this chapter carefully to understand safe installation procedures before installing the robots and robotic equipment.

## 1.3 Operation Safety

The following items are safety precautions for qualified Operator personnel:

 <b>WARNING</b>	<ul style="list-style-type: none"> <li>■ Please carefully read the <i>Safety-related Requirements</i> in the <i>Safety</i> chapter of the <i>Safety and Installation</i> manual. Operating the robot system without understanding the safety requirements is extremely hazardous and may result in serious bodily injury and/or severe equipment damage to the robot system.</li> <li>■ Do not enter the operating area of the Manipulator while the power to the robot system is turned ON. Entering the operating area with the power ON is extremely hazardous and may cause serious safety problems as the Manipulator may move even if it seems to be stopped.</li> <li>■ Before operating the robot system, make sure that no one is inside the safeguarded area. The robot system can be operated in the mode for teaching even when someone is inside the safeguarded area. The motion of the Manipulator is always in restricted status (low speeds and low power) to secure the safety of an operator. However, operating the robot system while someone is inside the safeguarded area is extremely hazardous and may result in serious safety problems in case that the Manipulator moves unexpectedly.</li> <li>■ Immediately press the Emergency Stop switch whenever the Manipulator moves abnormally during operation. Continuing the operation while the Manipulator moves abnormally is extremely hazardous and may result in serious bodily injury and/or severe equipment change to the robot system.</li> </ul>
 <b>WARNING</b>	<ul style="list-style-type: none"> <li>■ Be sure to connect the AC power cable to a power receptacle. <b>DO NOT</b> connect it directly to a factory power source. To shut off power to the robot system, disconnect the power plug from the power source. Performing any work while connecting the AC power cable to a factory power source is extremely hazardous and may result in electric shock and/or malfunction of the robot system.</li> <li>■ Before performing any replacement procedure, turn OFF the Controller and related equipment, and then disconnect the power plug from the power source. Performing any replacement procedure with the power ON is extremely hazardous and may result in electric shock and/or malfunction of the robot system.</li> <li>■ Do not connect or disconnect the motor connectors while the power to the robot system is turned ON. Connecting or disconnecting the motor connectors with the power ON is extremely hazardous and may result in serious bodily injury as the Manipulator may move abnormally, and also may result in electric shock and/or malfunction of the robot system.</li> </ul>



CAUTION

- Whenever possible, only one person should operate the robot system. If it is necessary to operate the robot system with more than one person, ensure that all people involved communicate with each other as to what they are doing and take all necessary safety precautions.
- If the joints are operated repeatedly with the operating angle less than 5 degrees, they may get damaged early because the bearings are likely to cause oil film shortage in such situation. To prevent early breakdown, move the joints larger than 30 degrees for about five to ten times a day.
- Oscillation (resonance) may occur continuously in low speed Manipulator motion (Speed: approx. 5 to 20%) depending on combination of Arm orientation and end effector load. Oscillation arises from natural oscillation frequency of the Arm and can be controlled by following measures.

- Changing Manipulator speed
- Changing the teach points
- Changing the end effector load



## 1.4 Emergency Stop

If the Manipulator moves abnormally during operation, immediately press the Emergency Stop switch. Pressing the Emergency Stop switch immediately changes the Manipulator to deceleration motion and stops it at the maximum deceleration speed.

However, avoid pressing the Emergency Stop switch unnecessarily while the Manipulator is running normally. Otherwise, the Manipulator may hit the peripheral equipment since the operating trajectory until the robot system stops is different from that in normal operation.

Do not press the Emergency Stop switch unnecessarily while the Manipulator is operating. Pressing the switch during operation makes the brakes work. This will shorten the life of the brakes due to the worn friction plates.

Normal brake life cycle: About 2 years (when the brakes are used 100 times/day)

Also, the Emergency Stop during operation applies impact on the reduction gear unit, and it may result in the short life of the reduction gear unit.

To place the robot system in emergency mode during normal operation, press the Emergency Stop switch while the Manipulator is not moving.

Refer to the Robot Controller manual for instructions on how to wire the Emergency Stop switch circuit.

Do not turn OFF the Controller while the Manipulator is operating.

If you attempt to stop the Manipulator in emergency situations such as “Safeguard Open”, make sure to stop the Manipulator using the Emergency Stop switch of the Controller.

If the Manipulator is stopped by turning OFF the Controller while it is operating, the following problems may occur.

Reduction of the life and damage of the reduction gear unit

Position gap at the joints

In addition, if the Controller was forced to be turned OFF by blackouts and the like while the Manipulator is operating, make sure to check the following points after power restoration.

Whether or not the reduction gear is damaged

Whether or not the joints are in their proper positions

If there is a position gap, perform calibration by referring to the *Maintenance 16. Calibration* in this manual.

Before using the Emergency Stop switch, be aware of the followings.

- The Emergency Stop (E-STOP) switch should be used to stop the Manipulator only in case of emergencies.
- To stop the Manipulator operating the program except in emergency, use Pause (halt) or STOP (program stop) commands.  
Pause and STOP commands do not turn OFF the motors. Therefore, the brake does not function.
- For the Safeguard system, do not use the circuit for E-STOP.

For details of the Safeguard system, refer to the following manuals.

*EPSON RC+ User's Guide 2. Safety - Installation and Design Precautions  
- Safeguard System*

*Safety and Installation 2.6 Connection to EMERGENCY Connector*

To check brake problems, refer to the following manuals.

*Manipulator Manual Maintenance 2.1.2 Inspection Point*

*- Inspection While the Power is ON  
(Manipulator is operating)*

*Safety and Installation*

*5.1.1 Manipulator*

*- Inspection While the Power is ON  
(Manipulator is operating)*

### Free running distance in emergency

The Manipulator in operation cannot stop immediately after the Emergency Stop switch is pressed. However, time, angle, and distance of the free running vary by following factors:

Hand weight      WEIGHT Setting      ACCEL Setting  
Workpiece weight      SPEED Setting      Posture etc.

Approximate time and distance of the free running are as follow:

#### Conditions of Measurement

	C8 series
ACCEL Setting	100
SPEED Setting	100
Load [kg]	8
WEIGHT Setting	8

Robot Controller			RC700-A		
Manipulator			C8-A701*** (C8)	C8-A901*** (C8L)	C8-A1401*** (C8XL)
Free running time [s]	Arm #1	Table Top	0.5	0.5	0.9
		Ceiling			
		Wall			
	Arm #2		0.5	0.6	0.7
	Arm #3		0.5	0.5	0.4
	Arm #4		0.5	0.4	0.5
	Arm #5		0.2	0.2	0.3
Arm #6		0.2	0.2	0.3	
Free running angle [°]	Arm #1	Table Top	60	50	70
		Ceiling			
		Wall			
	Arm #2		60	60	40
	Arm #3		70	50	30
	Arm #4		70	60	90
	Arm #5		30	30	50
Arm #6		40	30	30	

## 1.5 How to Move Arms with the Electromagnetic Brake

There are two methods to release the electromagnetic brake. Follow either method to release the electromagnetic brake and move the arms manually.

### 1.5.1 Moving the arm using the brake release unit

Follow the method when you just unpack the delivered boxes or when the Controller does not start up yet.

### 1.5.2 Moving the arm using the software

Follow the method when you can use the software.

While the electromagnetic brake is ON (such as in emergency mode), you cannot move any arm by pushing manually.

### Arm Motion

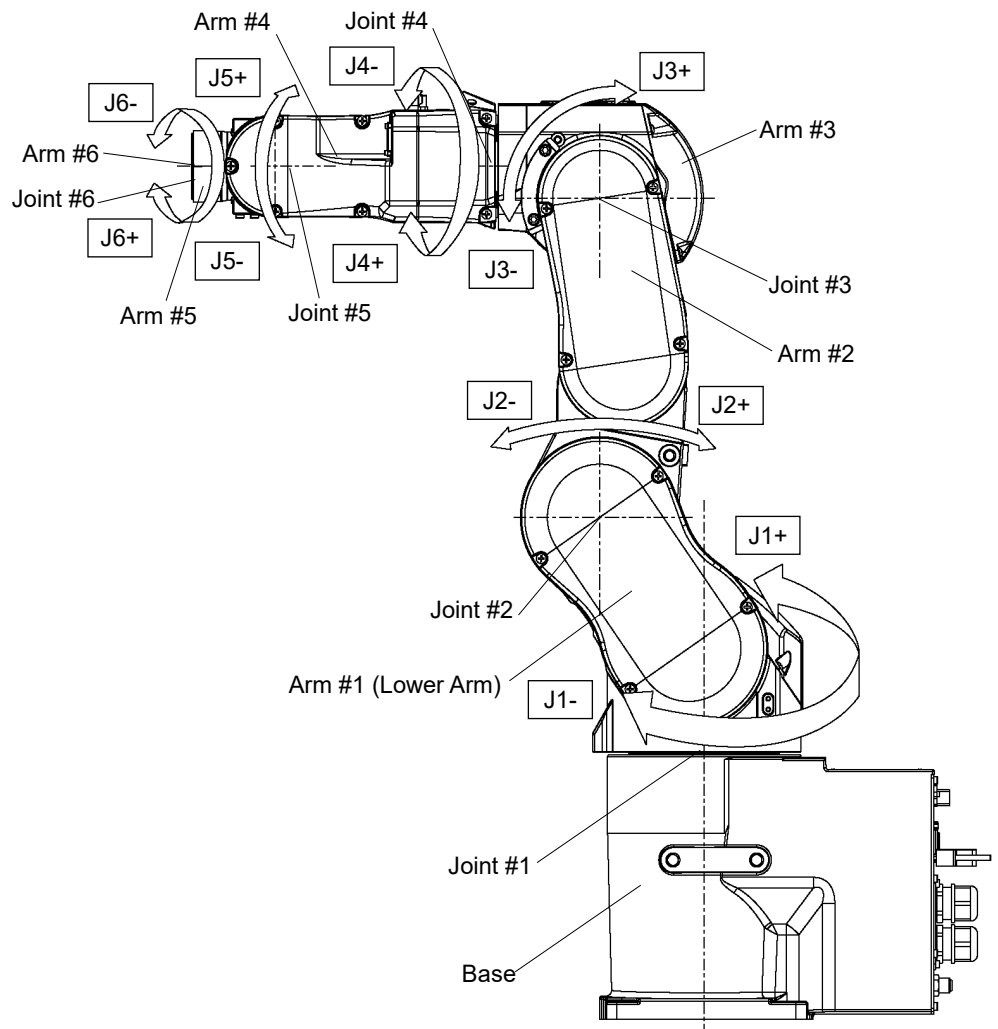

(Figure: C8-A701\* (C8))

### 1.5.1 Moving the Arm using the brake release unit

The C8 series has the Brake Release Unit as an option.

For details, refer to *Setup & Option: 6 Options*.

### 1.5.2 Moving the Arm using the software

 <b>CAUTION</b>	<ul style="list-style-type: none"> <li>■ Normally, release the brake of joints one by one. Take extra care if you need to release the brakes of two or more joints simultaneously. Releasing the brakes of two or more joints simultaneously may cause hands and fingers to be caught and/or equipment damage to or malfunction of the Manipulator as the arms of the Manipulator may move in unexpected directions.</li> <li>■ Be careful of the arm falling when releasing the brake. While the brake is being released, the Manipulator's arm falls by its own weight. The arm falling may cause hands and fingers to be caught and/or may cause equipment damage to or malfunction of the Manipulator.</li> <li>■ Before releasing the brake, be sure to keep the Emergency Stop switch handy so that you can immediately press the Emergency Stop switch. Otherwise, you cannot immediately stop the arm falling due to an erroneous operation. The arm falling may cause equipment damage to and/or malfunction of the Manipulator.</li> </ul>
---	--



After releasing the Emergency Stop switch, execute the following command in [Command Window].

>Reset

>Brake Off, [the number (from 1 to 6) corresponding to the arm whose brake will be turned off]

Execute the following command to turn on the brake again.

>Brake On, [The number (from 1 to 6) corresponding to the arm whose brake will be turned on]

## 1.6 Precaution for Operation in Low Power Status

In the low power status, the Manipulator operates at low speed and low torque. However, comparatively high torque as shown in the table below may be generated to support the Manipulator's own weight.

Carefully operate the Manipulator since it may get your hands or fingers caught during operation. The Manipulator may also collide with peripheral equipment and cause equipment damage to or malfunction of the Manipulator.

Maximum Joint Torque in Low Power Status [Unit: N·m]

Joint		#1	#2	#3	#4	#5	#6
Joint Torque	C8-A701*** (C8)	144.9	245.1	114.2	35.0	40.0	20.5
	C8-A901*** (C8L)	149.5	270.9	129.3			
	C8-A1401*** (C8XL)	299.9	487.6	248.9			

 <b>CAUTION</b>	<ul style="list-style-type: none"> <li>■ Carefully operate the Manipulator in the low power status. A comparatively high joint torque may be generated. It may cause your hands and fingers caught and/or cause equipment damage to or malfunction of the Manipulator as it may collide with peripheral equipment.</li> </ul>
---	---









## 1.7 Warning Labels

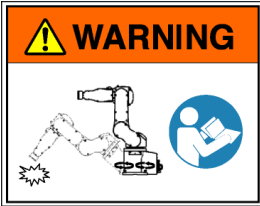

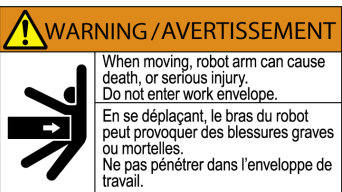
The Manipulator has the following warning labels.

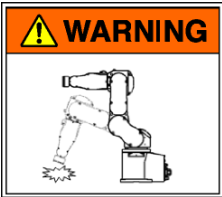

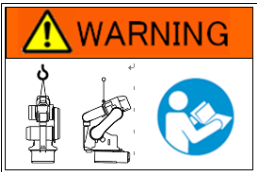
The warning labels are attached around the locations where specific dangers exist.

Be sure to comply with descriptions and warnings on the labels to operate and maintain the Manipulator safely.

Do not tear, damage, or remove the warning labels. Use meticulous care when handling those parts or units to which the following warning labels are attached as well as the nearby areas.

Location	Warning Label	NOTE
A	 	To avoid getting hands or fingers caught, fold the Arm and fix it with a belt or a similar tool before removing the base mounting screws.
B	 	Do not enter the work space when the Manipulator is operating. It is extremely hazardous since the Arm may collide and cause serious safety problems.
C		Do not touch the current-carrying parts inside the Manipulator while the power is ON. It may cause electrical shock.
D		When releasing the brakes, be careful of the arm falling due to its own weight. This warning label is attached on the Manipulator and optional brake release box.
		When the brake release box is used: Details of procedures for releasing the brakes using the brake release box are described in the Manipulator manuals.
E	 	Only authorized personnel should perform sling work and operate a crane and a forklift. When these operations are performed by unauthorized personnel, it is extremely hazardous and may result in serious bodily injury and/or severe equipment damage to the robot system.

Location	Warning Label	NOTE
F	  <b>! WARNING / AVERTISSEMENT</b> Do not put your hand on moving parts. Ne pas placer les mains sur les pièces mobiles.	You may get your hand or fingers caught when bringing your hand close to moving parts.

Location	Warning Label	Note	Location	Label
G		<b>HOT</b> Be careful not to burn yourself.	H	MODEL :C8-A701S SERIAL NO. :0000000000 MANUFACTURED:07/2015 WEIGHT:49Kg MAX PAYLOAD:8Kg MOTOR POWER AXIS1:1000W AXIS2:750W AXIS3:400W AXIS4:100W AXIS5:100W AXIS6:100W MANUFACTURER: SEIKO EPSON CORPORATION 3-5,OWA 3-CHOME,SUWA-SHI NAGANO-KEN,392-8502 JAPAN ENTITY PLACING ON EU MARKET: EPSON DEUTSCHLAND GmbH OTTO-HAHN-STR.4,D-40670 MEERBUSCH GERMANY <a href="https://neon.epson-europe.com/de/en/robots/">https://neon.epson-europe.com/de/en/robots/</a>  00001
			I	Air pressure max. 0.59Mpa, 86psi

Location of Labels

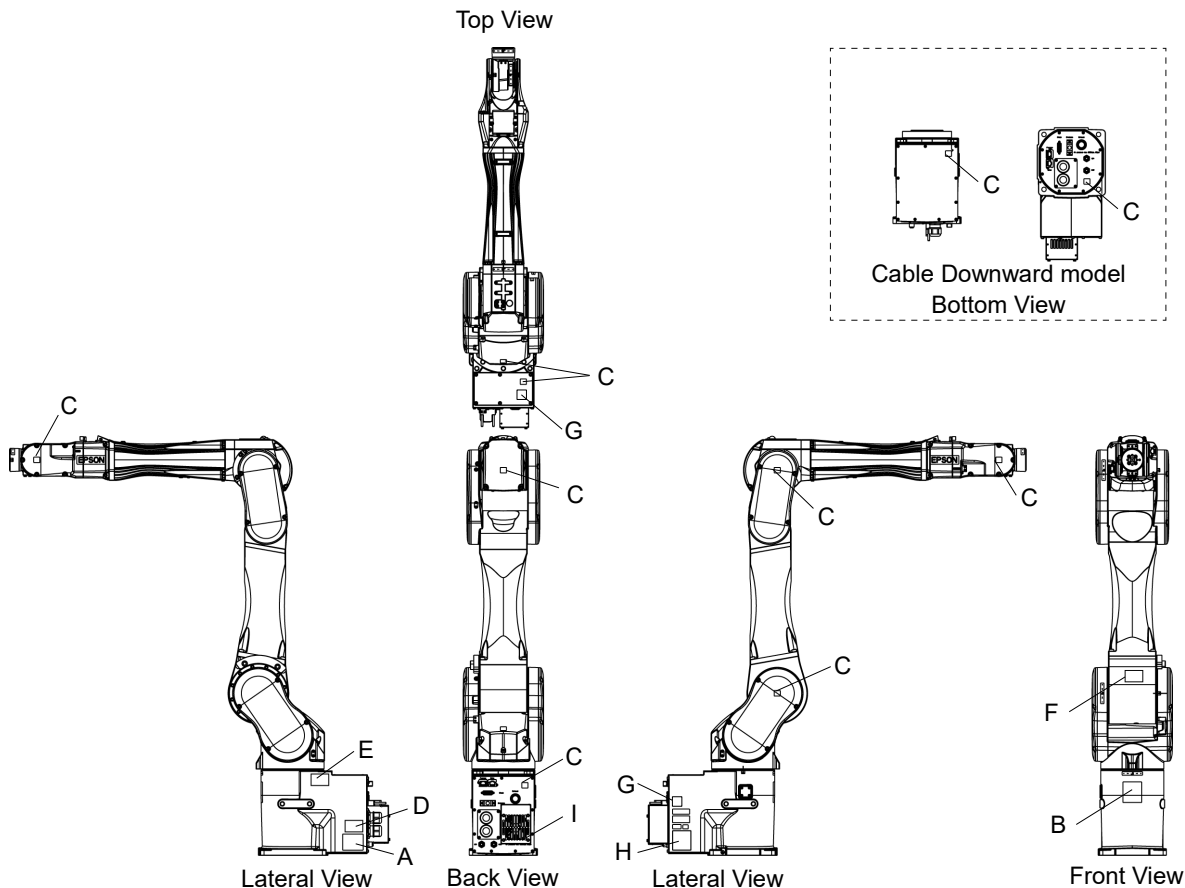

(Figure: C8-A1401\* (C8XL))

## 2. Specifications

### 2.1 Features of Manipulators

#### Speed & Accuracy

Increased productivity by balanced, best-in class fast and accurate operation.

High-speed, low-oscillation, and high-precision positioning by our technology even in heavy weight transportation.

Average cycle time (300 mm)

	1 kg	5 kg	8 kg
C8-A701*** (C8)	About 0.31 s	About 0.39 s	About 0.48 s
C8-A901*** (C8L)	About 0.35 s	About 0.43 s	About 0.50 s
C8-A1401*** (C8XL)	About 0.53 s	About 0.62 s	About 0.72 s

#### Slim Body

High space efficiency

Less interference with peripherals, walls, and ceiling permits more compact installation.

The system cost and installation cost can be reduced.

Manipulator weight

C8-A701\*\*\* (C8) : 49 kg (108 lbs.)

C8-A901\*\*\* (C8L) : 52 kg (115 lbs.)

C8-A1401\*\*\* (C8XL): 62 kg (137 lbs.)

#### Skillful Wrist

Compact wrist (Joint #5) with wide motion range enables smooth movement and the ability to work from many angles

Minimal interference with surroundings improves flexibility in hand design

## 2.2 Model Number

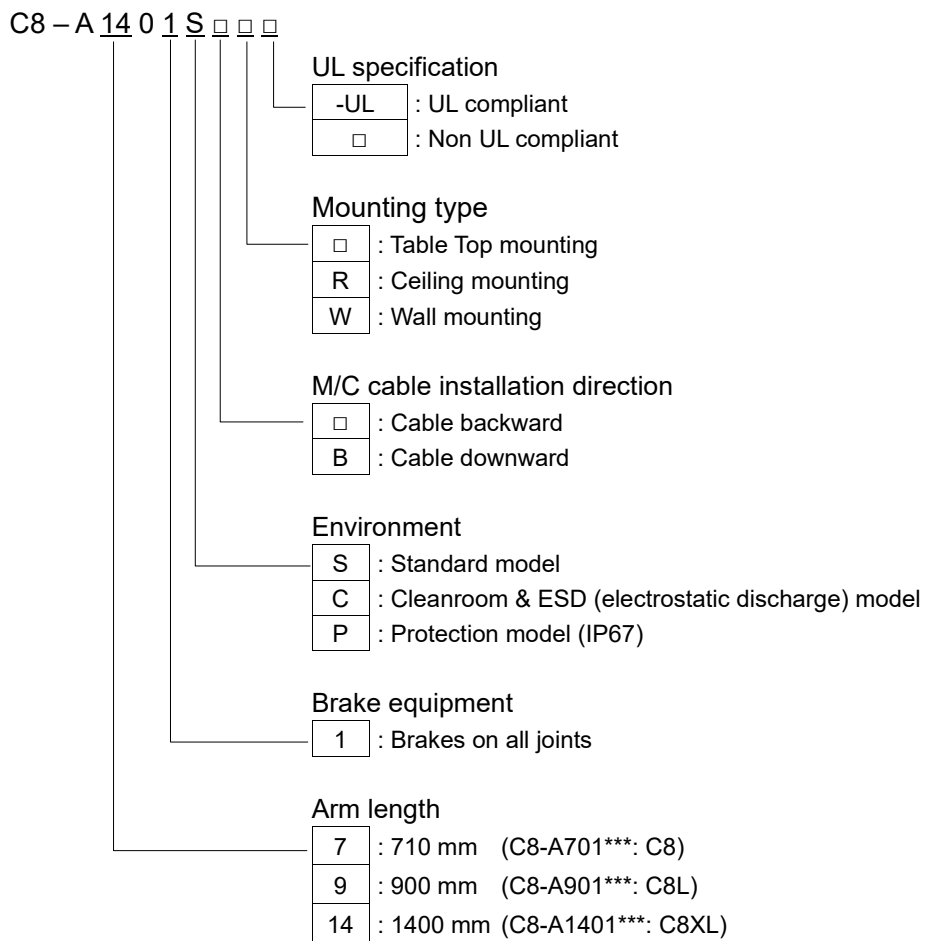

### Example

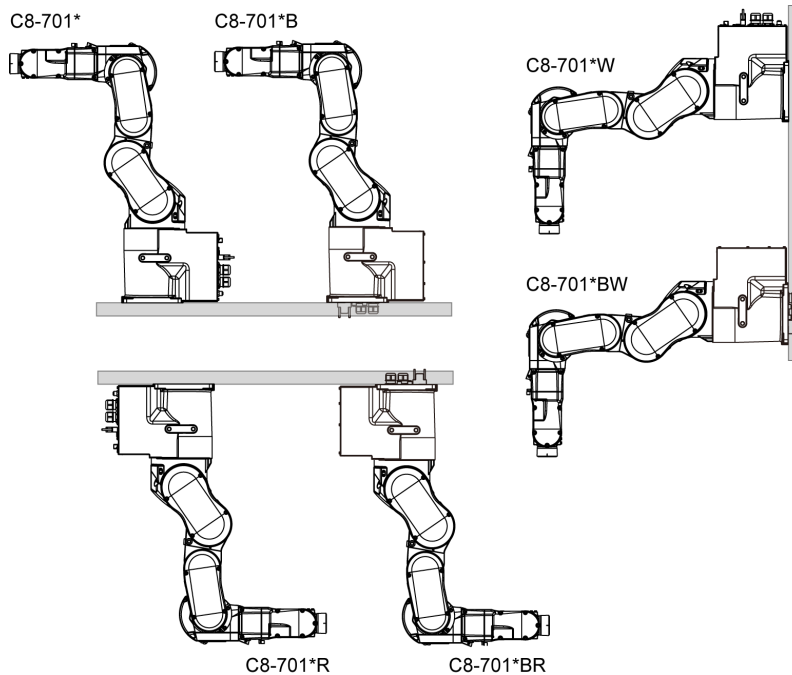



## 2.3 Part Names and Motion Range of Each Arm

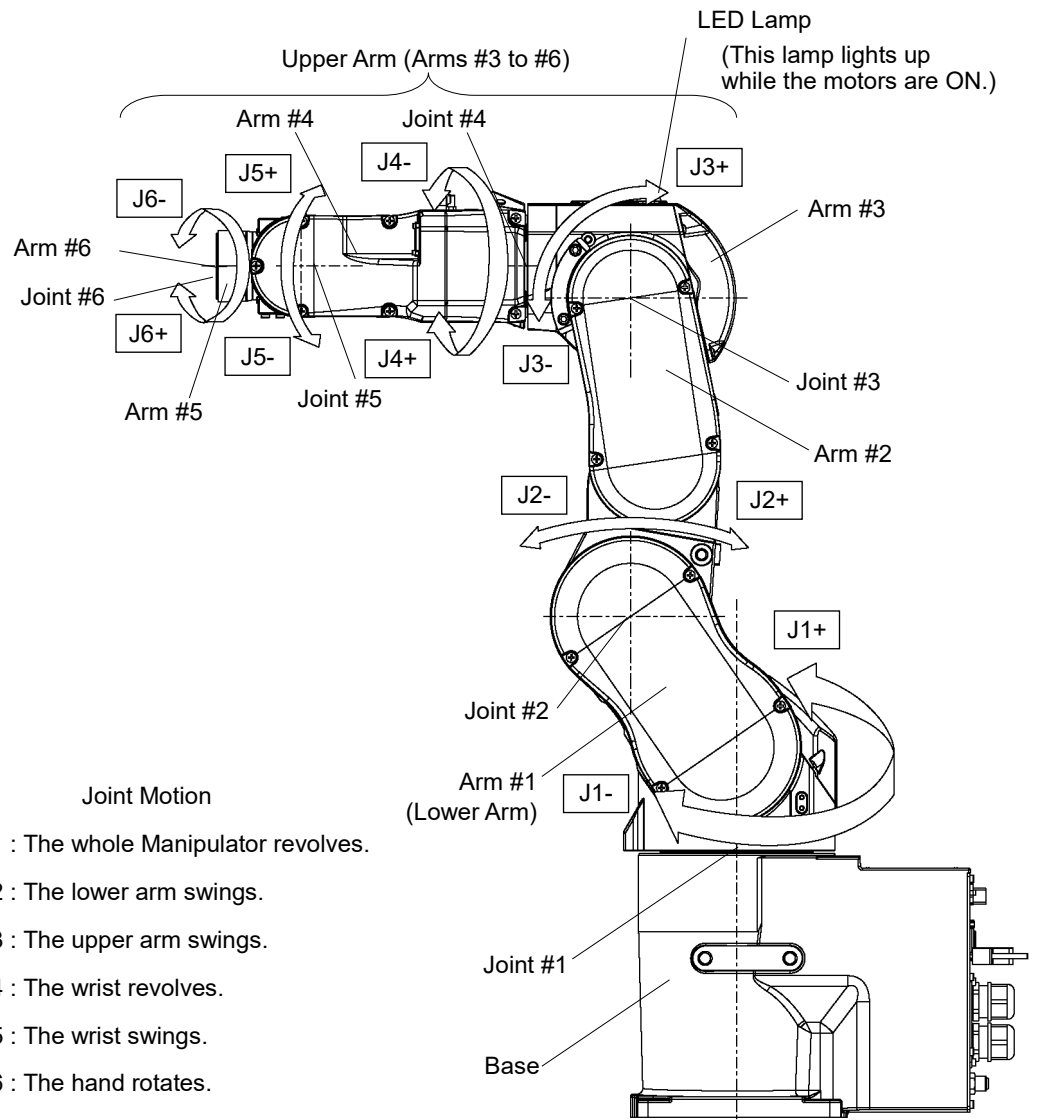

(Figure: C8-A701\* (C8))



When the LED lamp is lighting or the Controller power is on, current is being applied to the Manipulator. (The LED lamp may not be seen depending on the Manipulator's posture. Be very careful.)  
 Performing any work with the power ON is extremely hazardous and it may result in electric shock and/or improper function of the robot system. Make sure to turn OFF the Controller power before the maintenance work.

Cable backward model

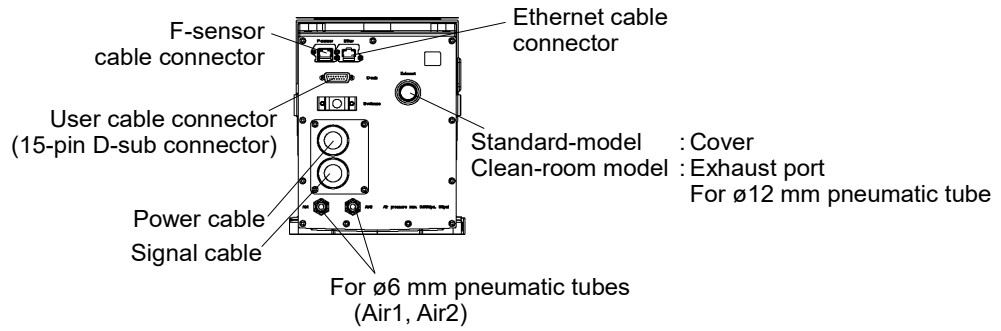

Cable downward model

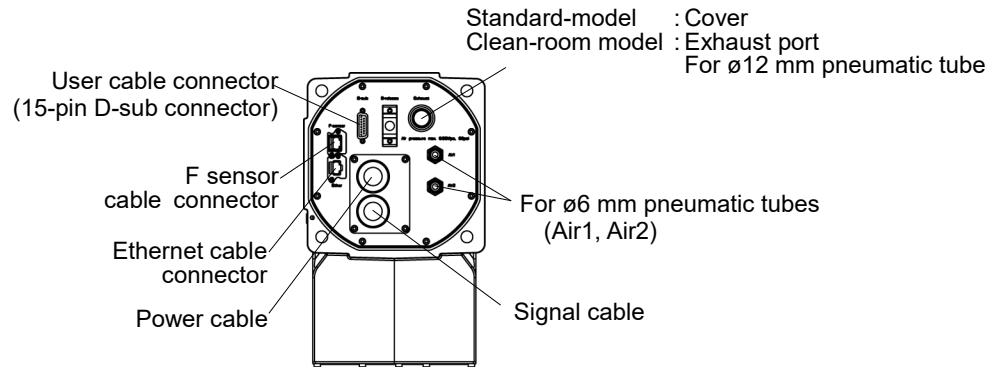

Cable backward model / Cable downward model

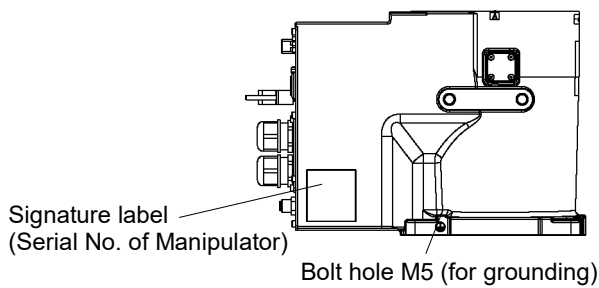

(Figure: Cable backward model)

2.4 Outer Dimensions

[Unit: mm]

2.4.1 C8-A701\*\*\* (C8)

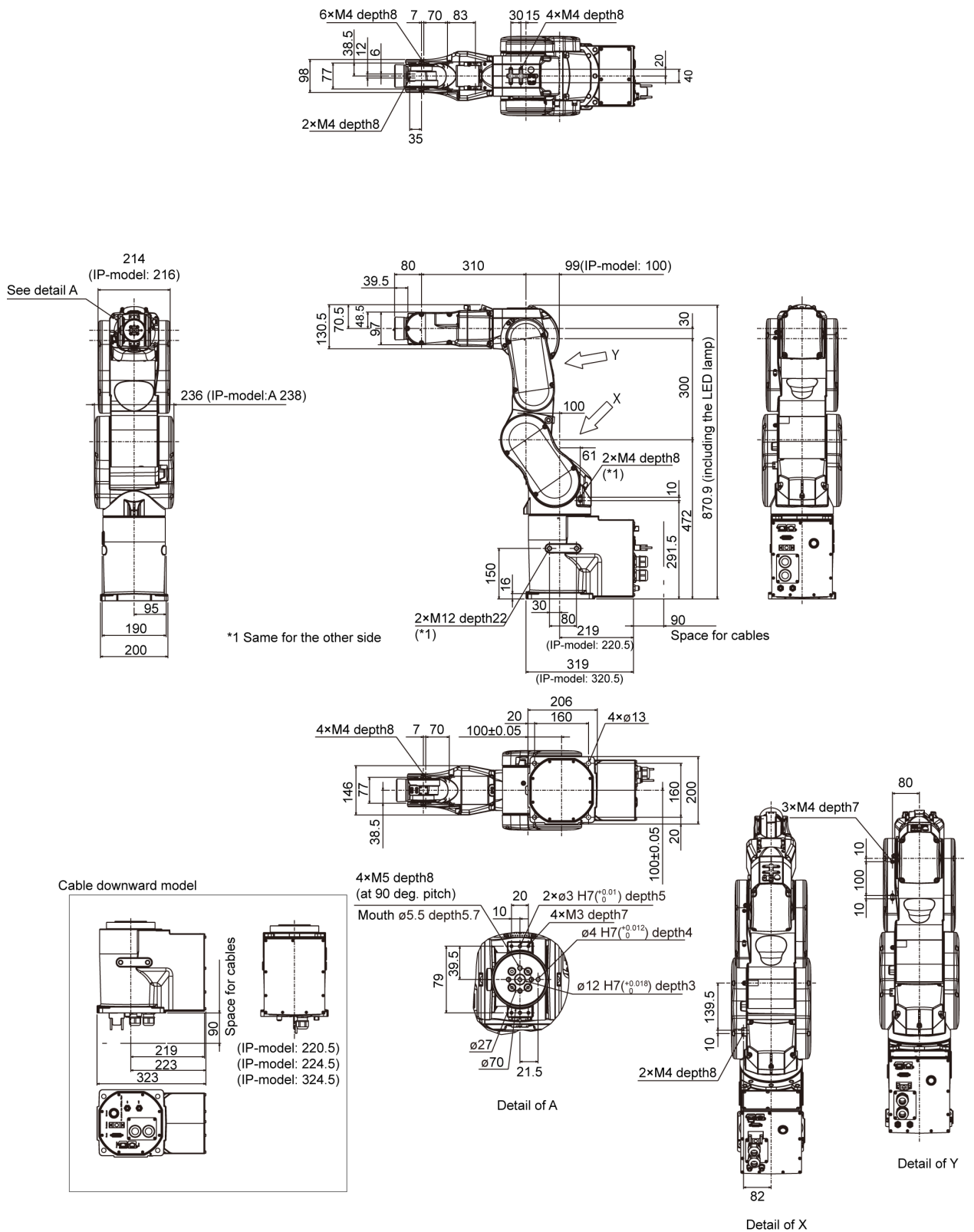

2.4.2 C8-A901\*\*\* (C8L)

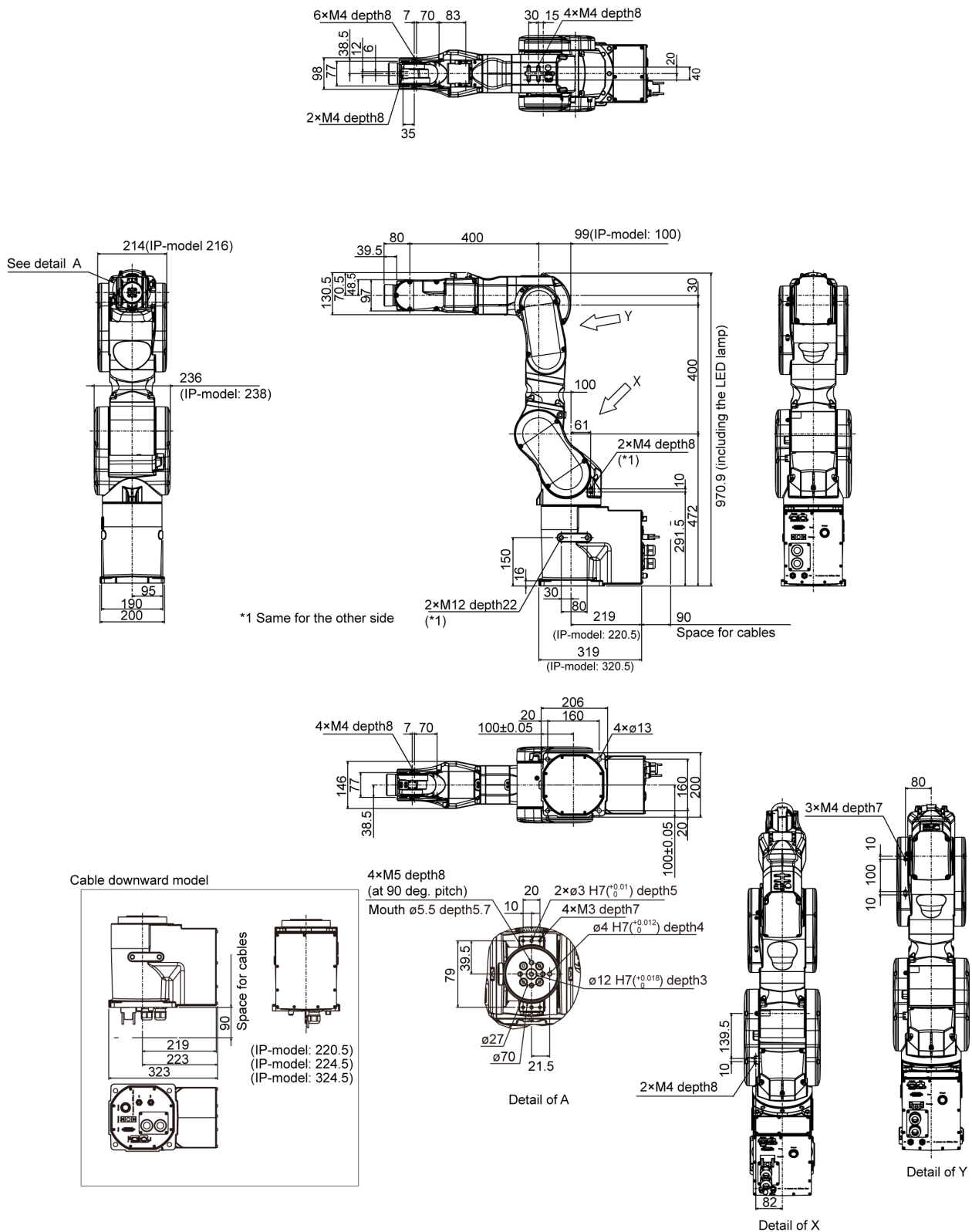

2.4.3 C8-A1401\*\*\* (C8XL)

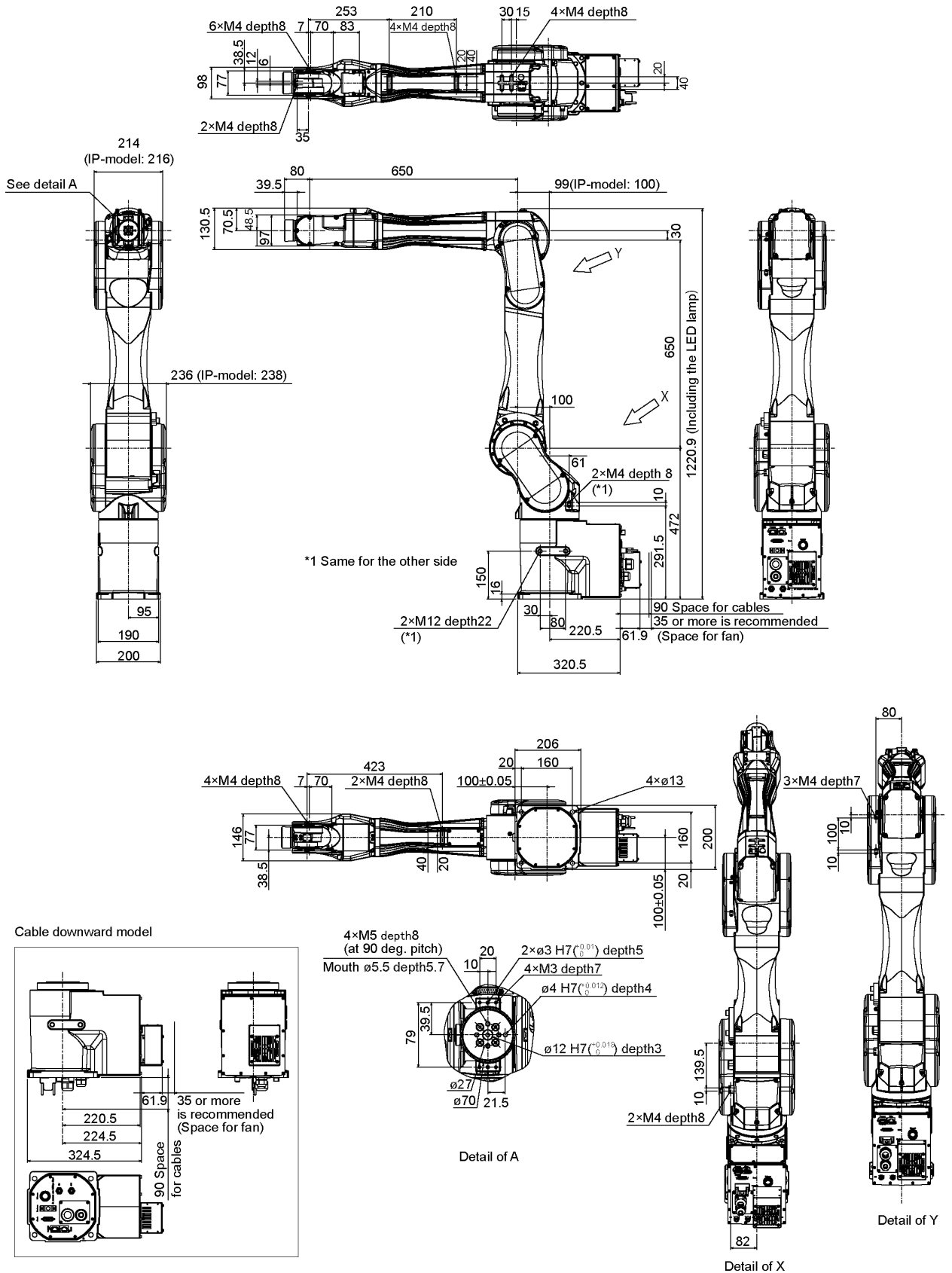

## 2.5 Standard Motion Range

### 2.5.1 C8-A701\*\*\* (C8)

[Unit: mm]

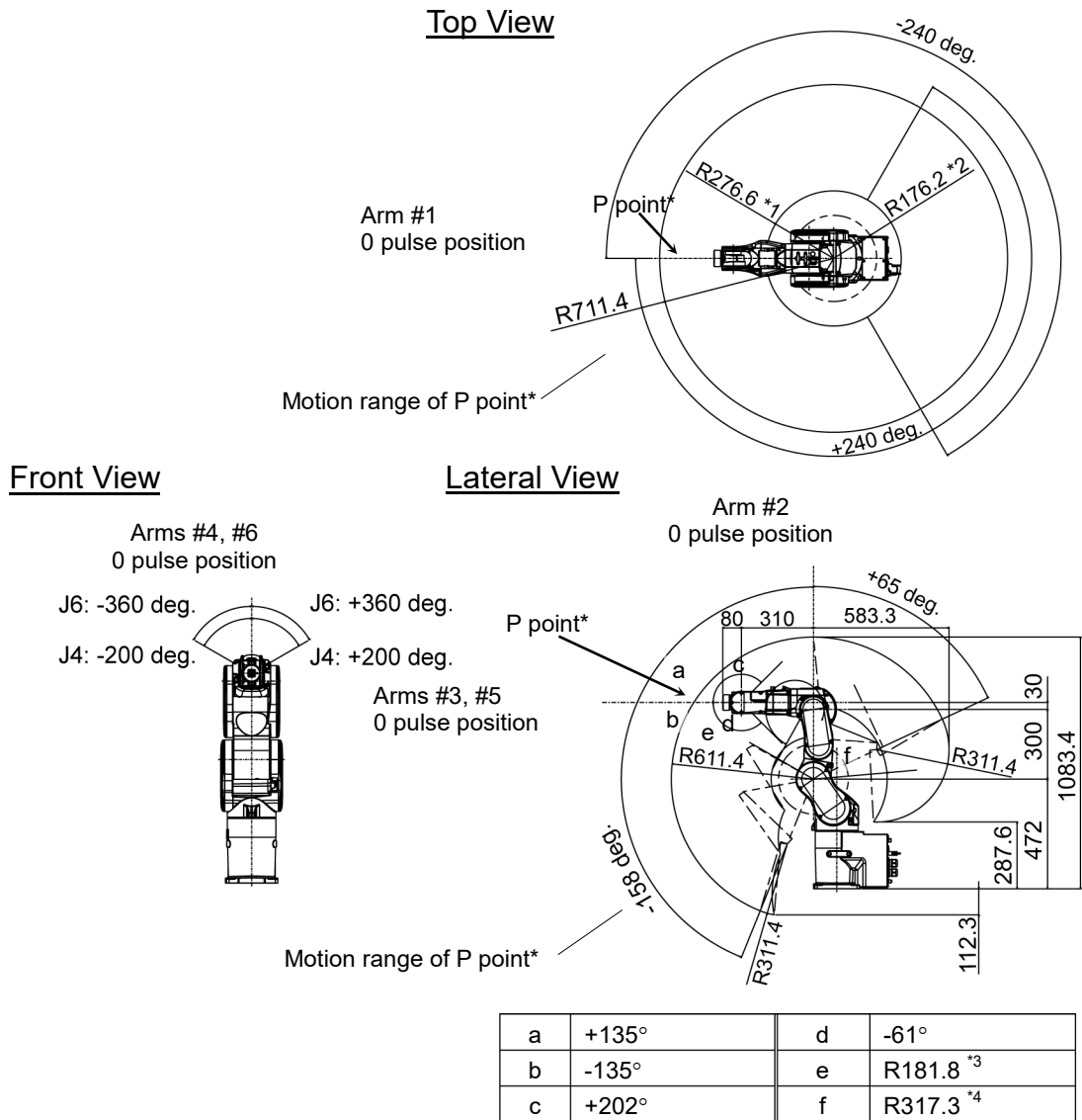

(deg.=°)

- \* P point : Intersection of the rotation centers for Joints #4, #5, and #6
- \*1 : P point from top with Joint #3 declining -61° (Joint #1 center – P point center)
- \*2 : P point from top with Joint #3 tilting up +202° (Joint #1 center – P point center)
- \*3 : P point from lateral with Joint #3 declining -61° (Joint #2 center – P point center)
- \*4 : P point from lateral with Joint #3 tilting up +202° (Joint #2 center – P point center)



CAUTION

- Pay attention to the arm pose of the basic arms (Arms #1, #2, and #3) when operating the Manipulator. Arm #5 moves keeping a constant angle regardless of the arm pose. Depending on the arm pose of the basic arms, the wrist may collide with the Manipulator. The collision may cause equipment damage to and/or malfunction of the Manipulator.

2.5.2 C8-A901\*\*\* (C8L)

[Unit: mm]

Top View

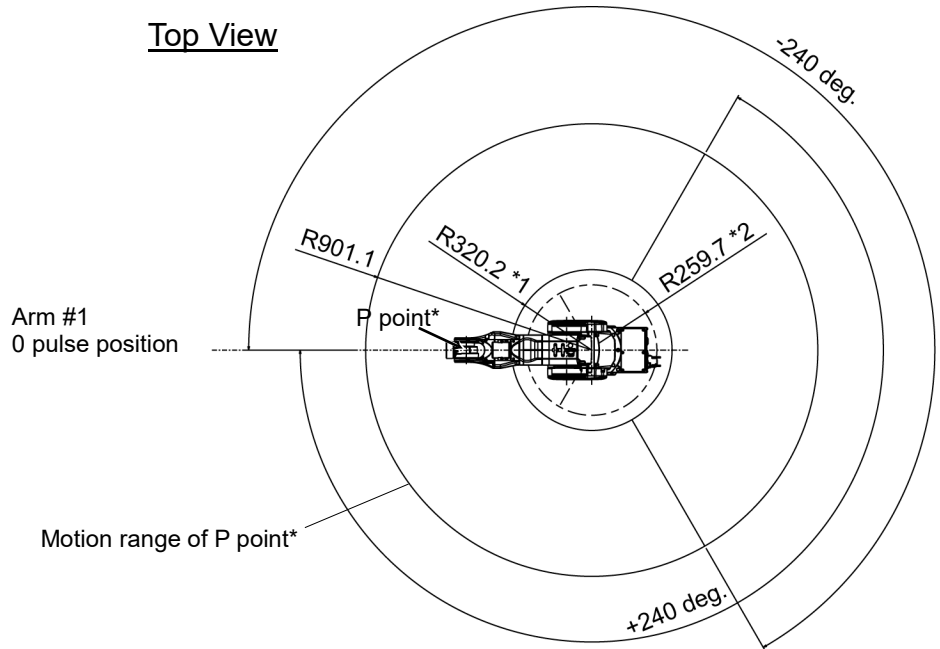

Front View

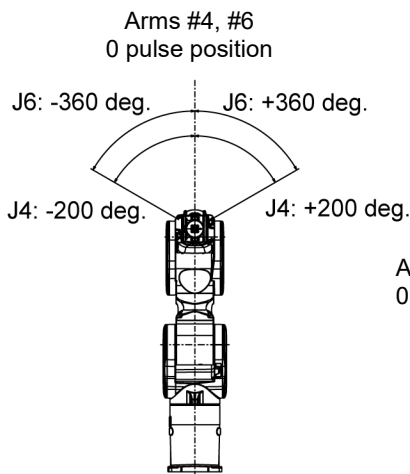

Lateral View

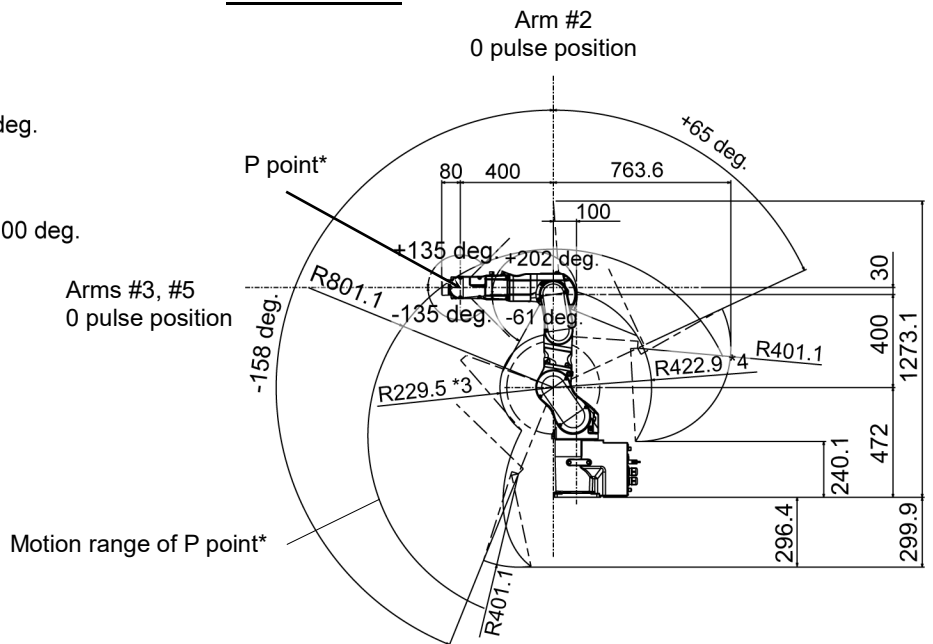

(deg.=°)

- \* P point : Intersection of the rotation centers for Joints #4, #5, and #6
- \*1 : P point from top with Joint #3 declining -61° (Joint #1 center - P point center)
- \*2 : P point from top with Joint #3 tilting up +202° (Joint #1 center - P point center)
- \*3 : P point from lateral with Joint #3 declining -61° (Joint #2 center - P point center)
- \*4 : P point from lateral with Joint #3 tilting up +202° (Joint #2 center - P point center)

 <b>CAUTION</b>	<p>■ Pay attention to the arm pose of the basic arms (Arms #1, #2, and #3) when operating the Manipulator. Arm #5 moves keeping a constant angle regardless of the arm pose. Depending on the arm pose of the basic arms, the wrist may collide with the Manipulator. The collision may cause equipment damage and/or malfunction of the Manipulator.</p>
---	---

2.5.3 C8-A1401\*\*\* (C8XL)

[Unit: mm]

Top View

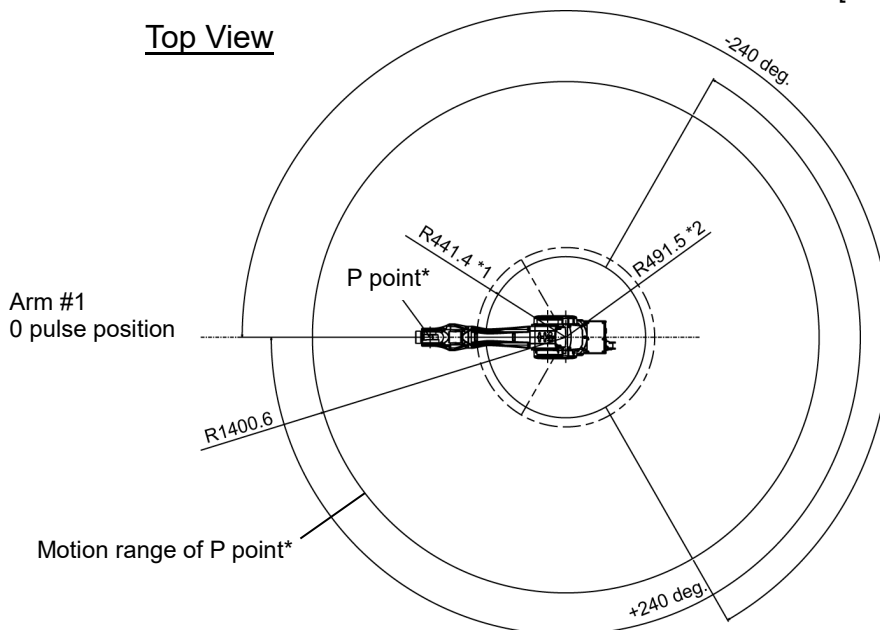

Front View

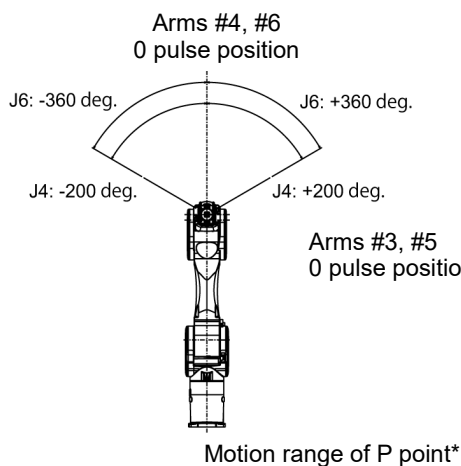

Lateral View

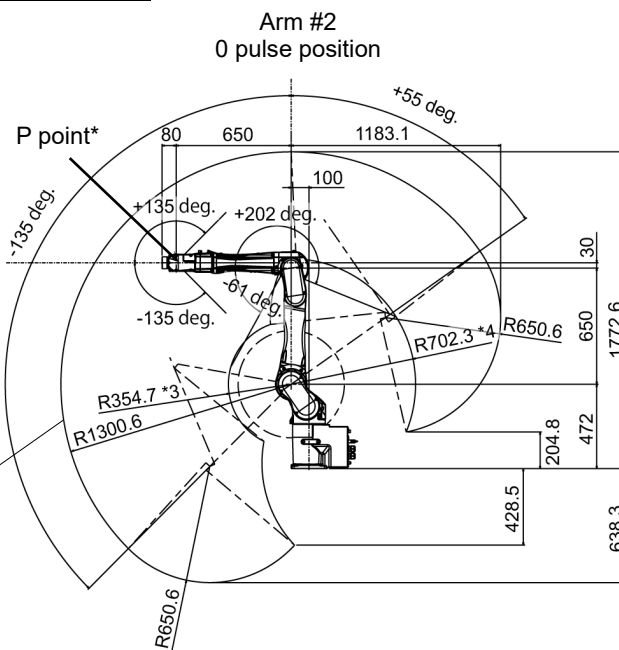

(deg.=°)

- \* P point : Intersection of the rotation centers for Joints #4, #5, and #6
- \*1 : P point from top with Joint #3 declining  $-61^\circ$  (Joint #1 center – P point center)
- \*2 : P point from top with Joint #3 tilting up  $+202^\circ$  (Joint #1 center – P point center)
- \*3 : P point from lateral with Joint #3 declining  $-61^\circ$  (Joint #2 center – P point center)
- \*4 : P point from lateral with Joint #3 tilting up  $+202^\circ$  (Joint #2 center – P point center)



CAUTION

■ Pay attention to the arm pose of the basic arms (Arms #1, #2, and #3) when operating the Manipulator. Arm #5 moves keeping a constant angle regardless of the arm pose. Depending on the arm pose of the basic arms, the wrist may collide with the Manipulator. The collision may cause equipment damage to and/or malfunction of the Manipulator.



## 2.6 Specifications

### 2.6.1 Specifications table

Item		Specification		
Model Number		C8-A701***	C8-A901***	C8-A1401***
Model Name		C8	C8L	C8XL
Mounting type* <sup>1</sup>		Table Top mounting, Ceiling mounting, Wall mounting		
Weight (not include the weight of cables or shipping jigs)	Standard Cleanroom & ESD	49 kg (108 lbs.)	52 kg (115 lbs.)	62 kg (137 lbs.)
	Protection	53 kg (117 lbs.)	56 kg (123 lbs.)	66 kg (146 lbs.)
Driving method		All joints AC servo motor		
Max. operating speed * <sup>2</sup>	Joint #1	331°/s	294°/s	200°/s
	Joint #2	332°/s	300°/s	167°/s
	Joint #3	450°/s	360°/s	200°/s
	Joint #4	450°/s		
	Joint #5	450°/s		
	Joint #6	720°/s		
Maximum synthetic speed		8958 mm/s	9679 mm/s	8858 mm/s
Repeatability	Joints #1 to #6	± 0.02 mm	± 0.03 mm	± 0.05 mm
Max. motion range	Joint #1	± 240°		
	Joint #2	- 158° to + 65°	- 158° to + 65°	- 135° to + 55°
	Joint #3	- 61° to + 202°		
	Joint #4	± 200°		
	Joint #5	± 135°		
	Joint #6	± 360°		
Max. pulse range	Joint #1	± 9507090	± 10695600	± 15736800
	Joint #2	-6245685 to +2569428	- 6903178 to +2839915	- 10616940 to +4325420
	Joint #3	-1776754 to +5883677	- 2220949 to +7354618	- 3997696 to +13238272
	Joint #4	± 5461400		
	Joint #5	± 3932280		
	Joint #6	± 6553800		
Resolution	Joint #1	0.0000252°/pulse	0.0000224°/pulse	0.0000153°/pulse
	Joint #2	0.0000253°/pulse	0.0000229°/pulse	0.0000127°/pulse
	Joint #3	0.0000343°/pulse	0.0000275°/pulse	0.0000153°/pulse
	Joint #4	0.0000366°/pulse		
	Joint #5	0.0000343°/pulse		
	Joint #6	0.0000549°/pulse		
Motor rated capacity	Joint #1	1000 W		
	Joint #2	750 W		
	Joint #3	400 W		
	Joint #4	100 W		
	Joint #5	100 W		
	Joint #6	100 W		
Payload * <sup>3</sup>	Rated	3 kg		
	Max.	8 kg		
Allowable moment	Joint #4	16.6 N·m (1.69 kgf·m)		
	Joint #5	16.6 N·m (1.69 kgf·m)		
	Joint #6	9.4 N·m (0.96 kgf·m)		

Item		Specification		
Model Number		C8-A701***	C8-A901***	C8-A1401***
Model Name		C8	C8L	C8XL
Allowable moment of inertia (GD2/4) *4	Joint #4	0.47 kg·m <sup>2</sup>		
	Joint #5	0.47 kg·m <sup>2</sup>		
	Joint #6	0.15 kg·m <sup>2</sup>		
Installed wire for customer use		15 wires (D-sub) 8 pin (RJ45) Cat 5e or equivalent 6 pin (for Force Sensor)		
Installed pneumatic tube for customer use *5		ø6 mm pneumatic tubes (2 tubes), Allowable pressure: 0.59 MPa (6 kgf/cm <sup>2</sup> ) (86 psi)		
Environmental requirements *6	Ambient Temperature	5 to 40°C		
	Ambient relative humidity	10 to 80 % (no condensation)		
	Vibration	4.9 m·s <sup>-2</sup> (0.5 G) or less		
Noise level *7		LAeq = 70 dB (A) or under		
Environment		Standard Cleanroom model & ESD *8 Protection model (IP67) *9		
Applicable Controller		RC700-A, RC700DU-A		
Default values (Max. setting values)	SPEED	3 (100)		
	ACCEL *10	5, 5 (120, 120)		
	SPEEDS	50 (2000)		
	ACCELS *11	200 (35000)	120 (25000)	
	FINE	10000, 10000, 10000, 10000, 10000, 10000 (130000, 130000, 130000, 130000, 130000, 130000)		
	WEIGHT	3 (8)		
	INERTIA	0.03 (0.15)		
Safety standard		CE Marking: EMC Directive, Machinery Directive KC Marking / KCs Marking UL standards (In case of UL specification): UL1740 ANSI/RIA R15.06 NFPA 79		

\*1: Mounting types other than “Table Top mounting”, “Ceiling mounting”, and “Wall mounting” are out of specification.

\*2: In case of PTP control

\*3: Do not apply the load exceeding the maximum payload.

\*4: If the center of gravity is at the center of each arm. If the center of gravity is not at the center of each arm, set the eccentric quantity using INERTIA command.

\*5: For details of the installed pneumatic tube for customer use, refer to the *Setup & Operation 3.6 User Wires and Pneumatic Tubes*.

\*6: For details of the environmental requirements, refer to the *Setup & Operation 3.1 Environmental Conditions*.

\*7: Conditions of Manipulator at measurement are as follows:

Operating conditions: Under rated load, 6 arms simultaneous motion, maximum speed, maximum acceleration/deceleration, and duty 50% for C8/ C8L, 30% for C8XL.

Measurement point: 1000 mm apart from the rear of Manipulator

\*8: The exhaust system in the Cleanroom-model Manipulator draws air from the base interior and arm cover interior.

A crack or other opening in the base unit can cause loss of negative air pressure in the outer part of the arm, which can cause increased dust emission.

Cleanliness level : C8, C8L ISO Class 3 (ISO14644-1)

: C8XL ISO Class 4 (ISO14644-1)

Exhaust system : Fitting for ø8 mm pneumatic tube  
(Reference: *Setup & Operation: 3.6 User Wires and Pneumatic Tubes*)  
60 L/min vacuum

Exhaust tube : Polyurethane tube Outer diameter: ø8 mm (Inner diameter: ø5 to 6 mm)

ESD specification uses resin materials with antistatic treatment. This model controls adhesion of dust due to electrification.

\*9 Protection level for the protection-model Manipulators is IP67 (IEC standard). The Manipulators can be used in environments where the possibility of dust, water, and water-soluble cutting oil falling of the Manipulator exists.

However, please be careful of the following:

- The Manipulator is not rust-proofed. Do not use the Manipulator in environment where corrosive liquids exist.
- Fluids that deteriorate the sealing materials, such as organic solvents, acids, alkalis, and chlorine cutting fluids, cannot be used
- The Manipulator cannot be used for underwater operations.
- The Controller does not have protection features against the environment (Controller's protection level: IP20)

Make sure to install the system where environmental requirements for the Controller are satisfied.

#### <Reference>

- IP40 of IEC standard

[Protection level against ingress of solid objects]

Protection from entry by solid objects with a diameter or thickness greater than 1.0 mm.

[Protection level against ingress of liquids]

No protection

- IP67 of IEC standard

[Protection level against ingress of solid objects]

Totally protected against dust.

[Protection level against liquids]

Protection from ingress of water in harmful quantity when the Manipulator is immersed in water for 30 minutes under the condition that the highest point of the Manipulator is located 0.15 m below the surface of the water and the lowest point is located 1 m below the surface of the water. (Tested while the Manipulator is stopped.)

\*10: In general use, Accel setting 100 is the optimum setting that maintains the balance of acceleration and vibration when positioning. Although values larger than 100 can be set to Accel, it is recommended to minimize the use of large values to necessary motions since operating the Manipulator continuously with the large Accel setting may shorten the product life remarkably.

\*11: Maximum AccelS setting value varies depending on the load. Refer to the table below for details. Setting the value which exceeds the maximum AccelS causes an error. In such a case, check the setting value.

Maximum AccelS setting value

Table Top mounting, Ceiling mounting

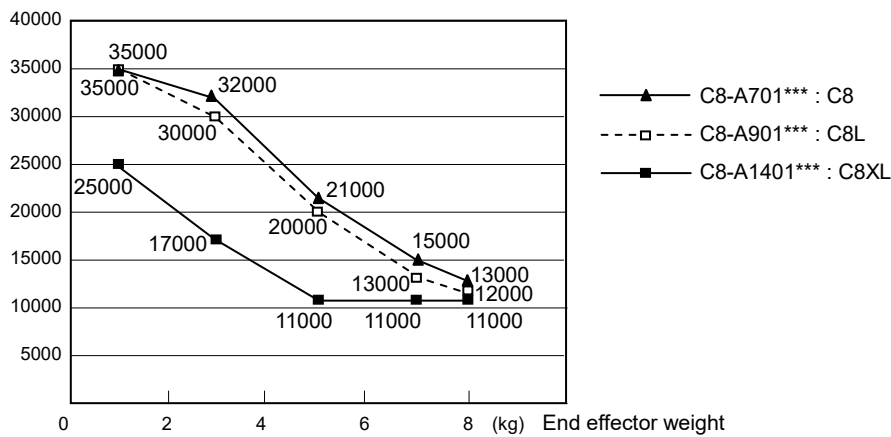

Wall mounting

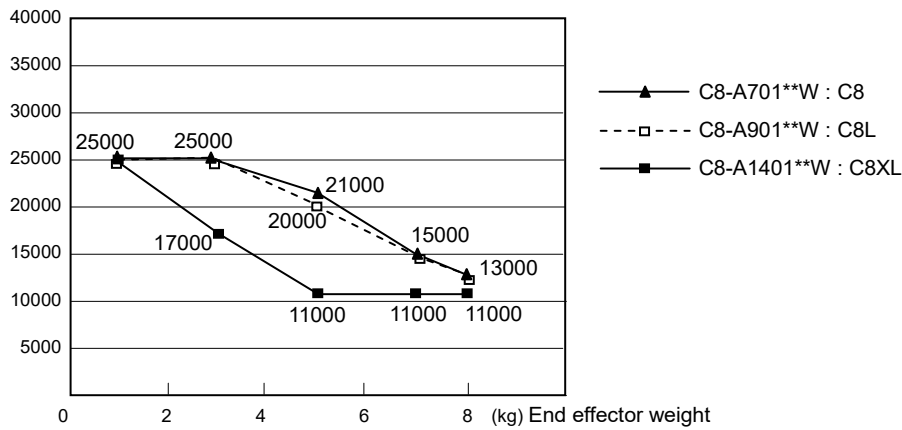

## 2.6.2 Option

C8 series have the following options.

For details of options, refer to *Setup & Operation: 6. Options*.

### User wires and pneumatic tube

Standard user connector kit	: Standard D-sub 15-pin × 2
Waterproof user connector kit	: IP67 waterproof D-sub 15-pin × 2 IP67 waterproof for RJ45 × 2
Fittings for customer use	: ø6, straight × 2 ø6, elbow × 2

### Adjustable mechanical stop

Adjustable mechanical stop	: J1 C8/C8L_J2 C8XL_J2 J3
----------------------------	------------------------------------

### Tool adapter

C8 ISO flange (J6)

### Camera plate unit

Camera mounting tool (common for C3 and C4 series)

### Brake release box \*1

For EU (power supply voltage 200 V, short connector included)

For US/JP (power supply voltage 100 V, short connector included)

Short connector for the brake release box

\*1: When using the brake release box with C8 series, it is necessary to connect the short connector to the M/C power cable or connect the M/C power cable with the Controller. (The brake release box can be used while the Controller is de-energized state.)

If you are using C3 or C4 series Manipulator and already have the brake release box, you can use it by connecting the M/C cable with the Controller, or purchasing the short connector separately and connecting it to the M/C power cable.

## 2.7 How to Set the Model

The Manipulator for your system has been set before shipment.



CAUTION

- When you need to change the setting of the Manipulator model, be sure to set the Manipulator model properly. Improper setting of the Manipulator model may result in abnormal or no operation of the Manipulator and/or cause safety problems.



NOTE

If the custom specifications number (MT\*\*\*) is described on MODEL of the signature label (S/N label), the Manipulator has custom specifications. (A label with only the custom specifications number may be attached depending on shipment time).

The custom specifications may require a different configuration procedure; check the custom specifications number (MT\*\*\*) and contact the supplier of your region if necessary.

The Manipulator model can be set from software.

Refer to the chapter *Robot Configuration* in the *EPSON RC+ User's Guide*.

## 3. Environment and Installation

Installation and transportation of robots and robotic equipment shall be performed by qualified personnel and should conform to all national and local codes.

### 3.1 Environmental Conditions

A suitable environment is essential for the robot system to function properly and safely. Be sure to install the robot system in an environment that meets the following conditions:

Item	Conditions
Ambient temperature <sup>*1</sup>	5 to 40 °C
Ambient relative humidity	10 to 80 % (no condensation)
First transient burst noise	1 kV or less (Signal wire)
Electrostatic noise	4 kV or less
Environment	<ul style="list-style-type: none"> <li>- Install indoors.</li> <li>- Keep away from direct sunlight.</li> <li>- Keep away from dust, oily smoke, salinity, metal powder or other contaminants.</li> <li>- Keep away from flammable or corrosive solvents and gases.</li> <li>- Keep away from water.</li> <li>- Keep away from shock or vibration.</li> <li>- Keep away from sources of electric noise.</li> </ul>

\*1 The ambient temperature conditions are for the Manipulators only. For the Controller which the Manipulator is connected to, refer to the Robot Controller manual.



When using the Manipulators in inadequate environments that do not meet the above conditions, please contact the distributor.

For the Protection-model Manipulator, be sure to install the robot system in an environment that also meets the following conditions:

Item	Conditions
Environment	<ul style="list-style-type: none"> <li>- Install indoors.</li> <li>- Keep away from direct sunlight.</li> <li>- Keep away from salinity or other contaminants.</li> <li>- Keep away from flammable or corrosive solvents (including water) and gases.</li> <li>- Keep away from organic solvents, acids, alkalis, and chlorine cutting fluids.</li> <li>- Do not use in water.</li> <li>- Keep away from shock or vibration.</li> <li>- Keep away from sources of electric noise.</li> <li>- Available under the environment with dust, oily smoke, and metal *2.</li> </ul>

\*1 The Manipulator body is mainly made of iron and aluminum. It is not rust-proofed.

Do not use the Manipulator under conditions where it can be exposed to water or any other corrosive liquid (including water).

- \*2 Any contaminants that can deteriorate sealing performance of nitrile rubber oil sealing, O-rings, packing seals and liquid gasket should be avoided.

#### Special Environmental Conditions



The protective seals are attached on the Protection-model Manipulator to prevent dust, water, etc. from the outside. Follow the precautions in use environment described below:

The surface of the Manipulator has general oil resistance. However, if your requirements specify that the Manipulator must withstand certain kinds of oil, please the supplier of your region.

Rapid change in temperature and humidity can cause condensation inside the Manipulator. If your requirements specify that the Manipulator handles food, please the supplier of your region to check whether the Manipulator will damage the food or not.

The Manipulator cannot be used in corrosive environments where acid or alkaline is used. In a salty environment where the rust is likely to gather, the Manipulator is susceptible to rust.

The Controller used with the Protection-model Manipulator does not have protection features for dusty, wet, or oily environment. The Controller must be placed in an environment that meets the specified conditions.

 WARNING	<ul style="list-style-type: none"> <li>■ Use an earth leakage breaker on the AC power cable of the Controller to avoid the electric shock and circuit breakdown caused by an unexpected water leak. Prepare the earth leakage breaker that pertains the Controller you are using. For details, refer to the Robot Controller manual.</li> </ul>
 CAUTION	<ul style="list-style-type: none"> <li>■ When cleaning the Manipulator, do not rub it strongly with alcohol or benzene. It may lose luster on the coated face.</li> </ul>



### 3.2 Unpacking, Transportation, and Relocation

Using a cart or similar equipment, transport the Manipulator in the same conditions as it was delivered. Observe the following when unpacking the Manipulator.

The installation shall be made by qualified installation personnel and should conform to all national and local codes.

 <b>WARNING</b>	<ul style="list-style-type: none"> <li>■ Only authorized personnel should perform sling work and operate a crane or a forklift. When these operations are performed by unauthorized personnel, it is extremely hazardous and may result in serious bodily injury and/or severe equipment damage to the robot system.</li> <li>■ Stabilize the Manipulator with your hands when hoisting it. Unstable hoisting is extremely hazardous and may result in serious bodily injury and/or severe equipment damage to the robot system as the fall of the Manipulator.</li> </ul>
---	--

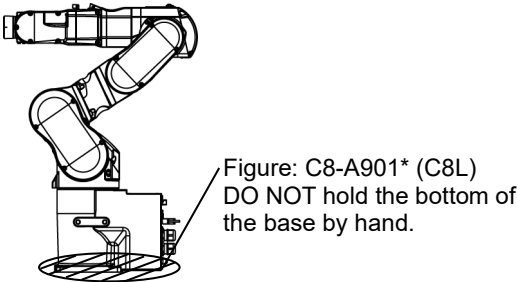
 <b>CAUTION</b>	<ul style="list-style-type: none"> <li>■ When removing the anchor bolts, support the Manipulator to prevent falling. Removing the anchor bolts without supporting the Manipulator may get hands, fingers, or feet caught as the Manipulator may fall.</li> <li>■ To transport the Manipulator, secure it to the delivery equipment or have at least 2 people to hold it by hand. Also, do not hold the bottom of the base (the screened parts in the figure). Holding these parts by hand is extremely hazardous and may cause your hands and fingers caught.</li> </ul> <div style="text-align: center; margin: 10px 0;">  </div> <p>Manipulator weight</p> <table border="1" style="width: 100%; border-collapse: collapse; margin: 10px 0;"> <thead> <tr> <th></th> <th>C8-A701***: C8</th> <th>C8-A901***: C8L</th> <th>C8-A1401***: C8XL</th> </tr> </thead> <tbody> <tr> <td>Standard, Cleanroom</td> <td>49 kg: 108 lbs.</td> <td>52 kg: 115 lbs.</td> <td>62 kg: 137 lbs.</td> </tr> <tr> <td>Protection</td> <td>53 kg: 117 lbs.</td> <td>56 kg: 123 lbs.</td> <td>66 kg: 146 lbs.</td> </tr> </tbody> </table> <ul style="list-style-type: none"> <li>■ Avoid excessive vibration or shock during Manipulator transporting. Excessive vibration or shock may cause equipment damage to and/or malfunction of the Manipulator.</li> </ul>		C8-A701***: C8	C8-A901***: C8L	C8-A1401***: C8XL	Standard, Cleanroom	49 kg: 108 lbs.	52 kg: 115 lbs.	62 kg: 137 lbs.	Protection	53 kg: 117 lbs.	56 kg: 123 lbs.	66 kg: 146 lbs.
	C8-A701***: C8	C8-A901***: C8L	C8-A1401***: C8XL										
Standard, Cleanroom	49 kg: 108 lbs.	52 kg: 115 lbs.	62 kg: 137 lbs.										
Protection	53 kg: 117 lbs.	56 kg: 123 lbs.	66 kg: 146 lbs.										

Be sure to transport and store the robot system in environments that meet the following conditions:

Item	Conditions
Ambient temperature	0 to 45 °C
Ambient relative humidity	10 to 80 % (no condensation)

During unpacking and relocation, avoid applying external force to the arms and motors of the Manipulator.

When transporting the Manipulator for a long distance, secure it to the delivery equipment so that the Manipulator cannot fall. If necessary, pack the Manipulator in the same way as it was delivered.

When condensation occurs on the Manipulator during transport or storage, turn ON the power only after the condensation dries.

When using the Manipulator for the robot system again after long-term storage, perform a test run to verify that the Manipulator works properly. Then, operate the Manipulator thoroughly.

### Relocating

Follow the procedures described below when relocating the Manipulator.

- Turn OFF the power for all devices and unplug the power cable connector and signal cable connector from the Controller.  
Do not unplug the M/C cable (power cable and signal cable) from the Manipulator. (M/C cable 3 m: 2 kg)



Remove the mechanical stops if using them to limit the motion range.  
For details on the motion range, refer to the *Setup & Operation 5.2 Motion Range Setting by Mechanical Stops*.

- Unscrew the anchor bolts. Then, remove the Manipulator from the base table.
- Position the Manipulator as shown in the figure. Then, secure the Manipulator to the delivery equipment or have at least 2 people to carry the Manipulator.

Recommend: Joint #2 +55°  
Joint #3 -55°

\* The posture is common to all models.

Do not hold the bottom of the base (the screened parts in the figure). Holding these parts by hand is extremely hazardous and may cause your hands and fingers to be caught.

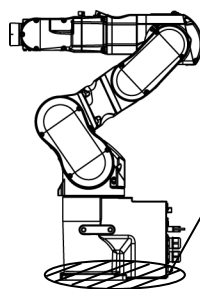

Figure: C8-A901\* (C8L)  
DO NOT hold the bottom of the base by hand.

### Manipulator weight

	C8-A701***: C8	C8-A901***: C8L	C8-A1401***: C8XL
Standard, Cleanroom	49 kg: 108 lbs.	52 kg: 115 lbs.	62 kg: 137 lbs.
Protection	53 kg: 117 lbs.	56 kg: 123 lbs.	66 kg: 146 lbs.

**Using Eyebolt**

Check that the eyebolts are securely fastened before carrying the Manipulator.

After transporting the Manipulator, remove the eyebolts and keep them for future use.

The eyebolts (accessory, 2 pcs) and wire must be strong enough to withstand the weight (See the figures below).

If you use the eyebolts to lift up the Manipulator, make sure to put hands on it to keep the balance. The Manipulator may fall if the balance is lost and this is extremely hazardous.

To prevent damage on the covers and arms, it is recommended to protect the contacting parts of the wire and arm with a cloth. Be very careful not to damage the covers since they are made of plastic.

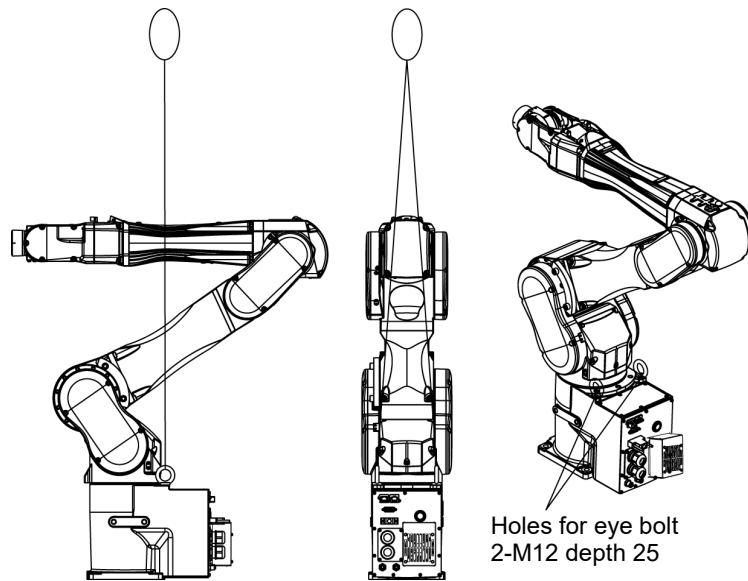

(Figure: C8-A1401\* (C8XL))

\* Locations of the screw holes for eyebolts are common to all models.

**Manipulator weight**

	C8-A701***: C8	C8-A901***: C8L	C8-A1401***: C8XL
Standard, Cleanroom	49 kg: 108 lbs.	52 kg: 115 lbs.	62 kg: 137 lbs.
Protection	53 kg: 117 lbs.	56 kg: 123 lbs.	66 kg: 146 lbs.

 <b>CAUTION</b>	<ul style="list-style-type: none"> <li>■ Remove the eyebolts from the Manipulator after transportation/relocation is completed.</li> </ul> <p>If the Manipulator is operated with the eyebolts left on it, the arm may collide with the eyebolts and it may cause equipment damage to and/or malfunction of the Manipulator.</p>
---	--

### 3.3 Mounting Dimensions

#### Mounting Area

Be sure to have the following space available in addition to the space for mounting the Manipulator, Controller, and peripheral equipment.

- Space for teaching points
- Space for maintenance and inspections (for installing jigs)
- Space for cables



The minimum bend radius of the power cable is 90 mm. When installing the cable, be sure to maintain sufficient distance from obstacles. In addition, leave enough space for other cables so that they are not bent forcibly.



In case of C8-A1401\*\*\* (C8XL):  
Make sure to leave 35 mm or more space around the fan cover.

[Unit: mm]

#### 3.3.1 Cable Backward Model

C8-A701\*\* (C8)

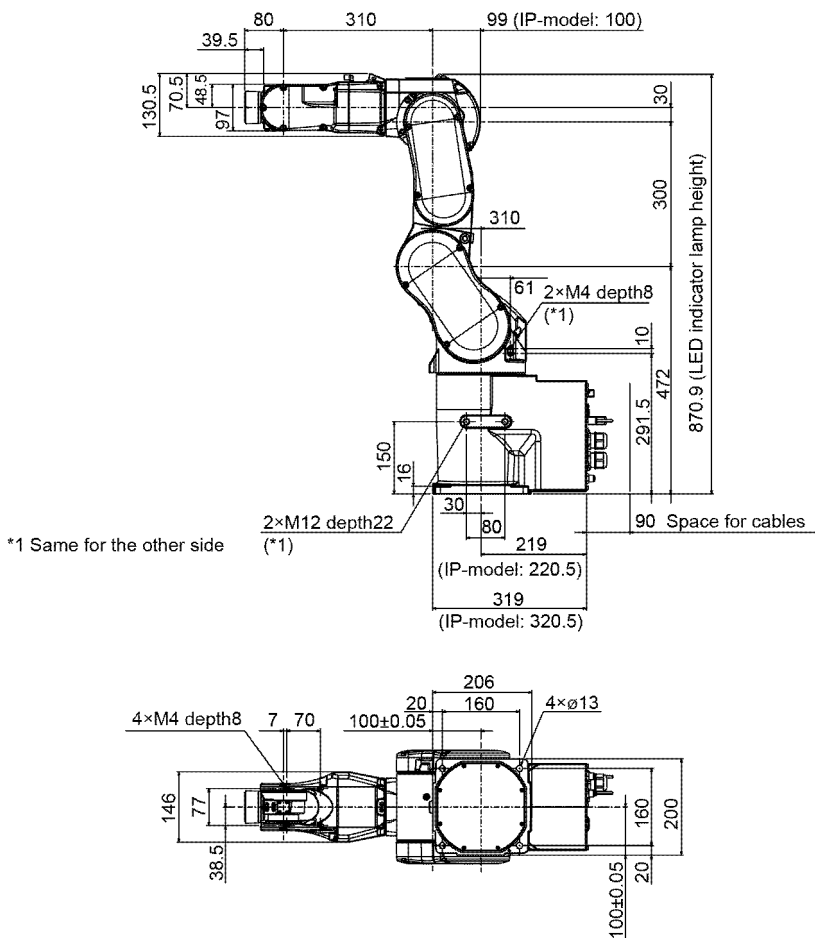

C8-A901\*\* (C8L)

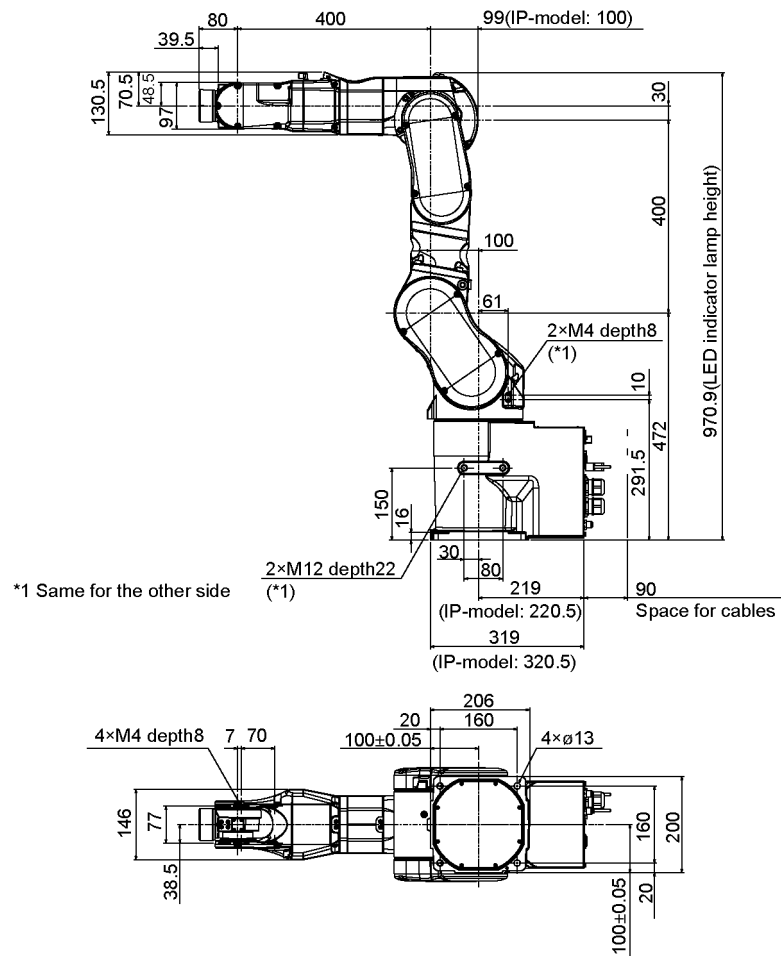

C8-A1401\*\* (C8XL)

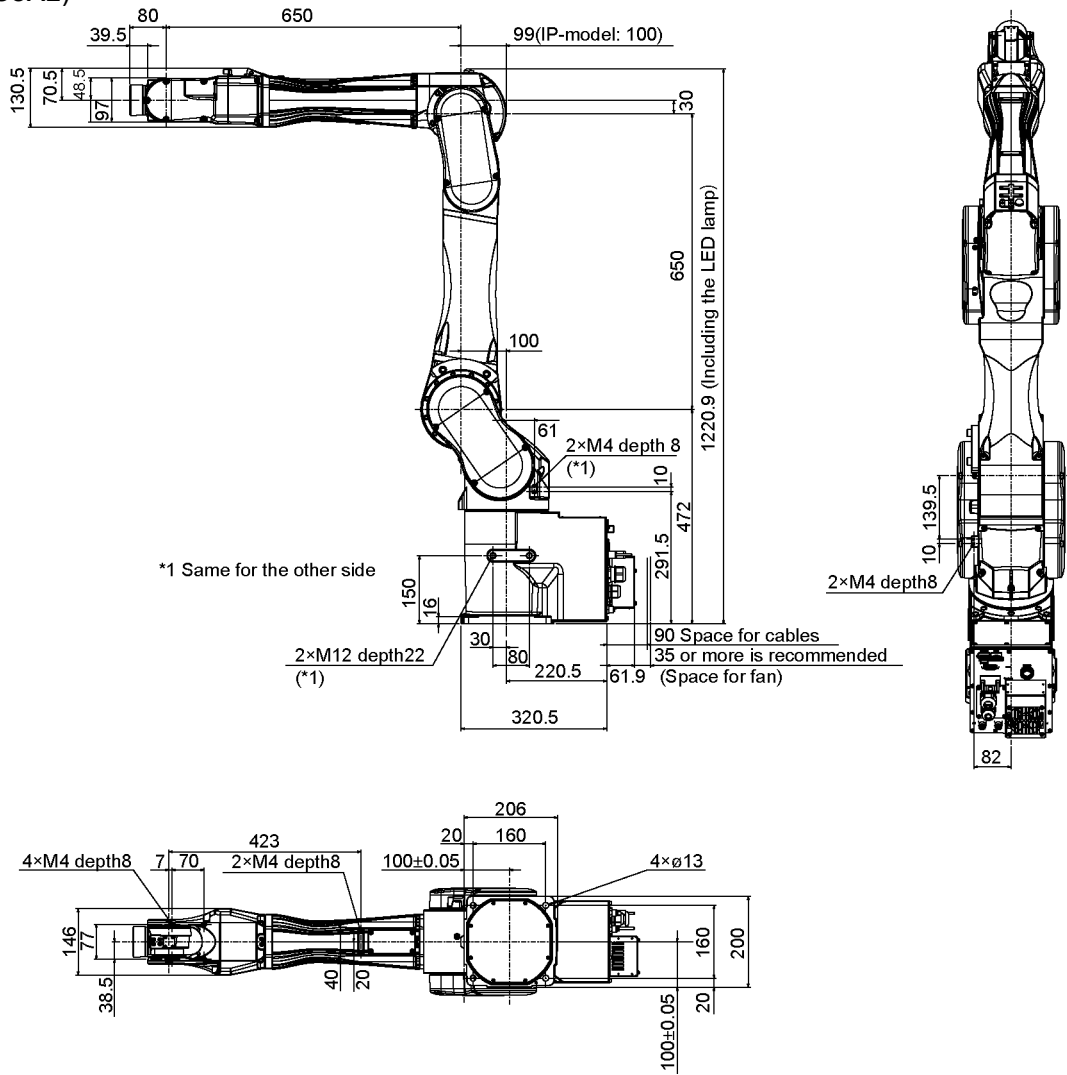

3.3.2 Cable Downward Model

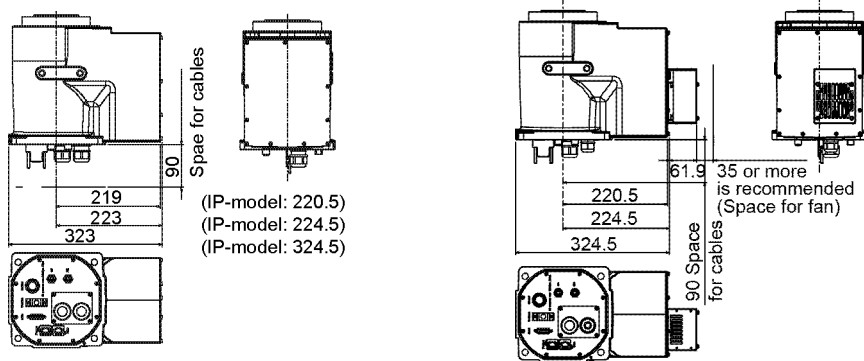

The following part differs from the cable backward model.

C8-A701\*B\* (C8), C8-A901\*B\* (C8L) C8-A1401\*B\* (C8XL)



## 3.4 Installation

The installation shall be made by qualified installation personnel and should conform to all national and local codes.

 <b>WARNING</b>	<ul style="list-style-type: none"> <li>■ To ensure safety, a safeguard must be installed for the robot system. For details on the safeguard, refer to the <i>Installation and Design Precautions</i> in the <i>Safety</i> chapter of the EPSON RC+ User's Guide.</li> <li>■ Install the Manipulator in a location with sufficient space so that a tool or a work piece does not touch a wall or a safeguard when the Manipulator extends its arm fully while holding a work piece. Installing the Manipulator at a location with insufficient space is extremely hazardous and may result in serious bodily injury and/or severe equipment damage to the robot system as a tool or a work piece may collide with a wall or a safeguard.</li> <li>■ Anchor the Manipulator before turning ON the power to or operating the Manipulator. Turning ON the power to or operating the Manipulator that is not anchored is extremely hazardous and may result in serious bodily injury and/or severe equipment damage to the robot system as the Manipulator may fall down.</li> <li>■ Before installing and operating the Manipulator, make sure that all parts of the Manipulator are in place and have no external defects. Missing or defective parts may cause improper operation of the Manipulator. Improper operation of the Manipulator is extremely hazardous and may result in serious bodily injury and/or severe equipment damage to the robot system.</li> </ul>
 <b>CAUTION</b>	<ul style="list-style-type: none"> <li>■ The Manipulator must be installed to avoid interference with buildings, structures, utilities, other machines and equipment that may create a trapping hazard or pinch points.</li> <li>■ Oscillation (resonance) may occur during operation depending on rigidity of the installation table. If the oscillation occurs, improve rigidity of the table or change the speed or acceleration and deceleration settings.</li> </ul>

### Mounting bolt

For the dimensions, refer to *Setup & Operation 3.3 Mounting Dimensions*.

There are four threaded holes for the Manipulator base.

Use M12 mounting bolts conforming to the strength of ISO898-1 property class 10.9 or 12.9.

Tightening torque:

$100.0 \pm 5.0 \text{ N}\cdot\text{m}$  ( $1,020 \pm 51 \text{ kgf}\cdot\text{cm}$ )

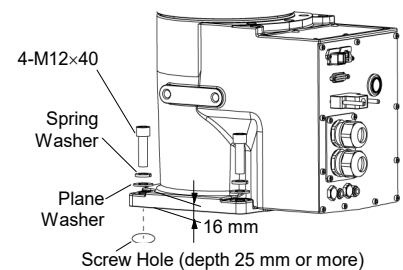

**Base table**

A base table for anchoring the Manipulator is not supplied. Please make or obtain the base table for your Manipulator. The shape and size of the base table differ depending on the intended use of the robot system. The following is the basic requirements of Manipulator table for your reference.

The base table must not only be able to bear the weight of the Manipulator but also be able to withstand the dynamic movement of the Manipulator when it operates at maximum acceleration/deceleration. Ensure that there is enough strength on the base table by attaching reinforcing materials such as crossbeams.

The torque and reaction force produced by the movement of the Manipulator are as follows:

Model number	C8-A701***	C8-A901***	C8-A1401***
Model name	C8	C8L	C8XL
Max. Horizontal rotating torque (N·m)	1,600	1,800	2,600
Max. Horizontal reaction force (N)	1,200	1,300	1,300
Max. Vertical rotating torque (N·m)	1,900	2,200	3,400
Max. Vertical rotating torque (N)	6,600	6,000	7,800

The plate for the Manipulator mounting face should be 30 mm thick or more and made of steel to reduce vibration. The surface roughness of the steel plate should be 25 μm or less. The base table must be secured on the floor to prevent it from moving.

The Manipulator must be installed horizontally.

When using a leveler to adjust the height of the base table, use a screw with M16 diameter or more.

**Connector**

If you are passing cables through the holes on the base table, see the figures below.  
[unit : mm]

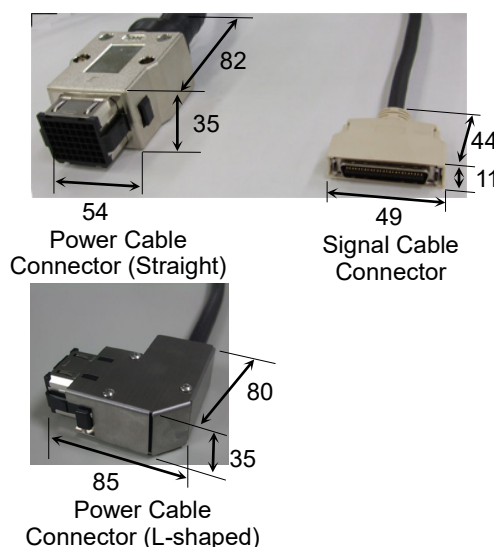
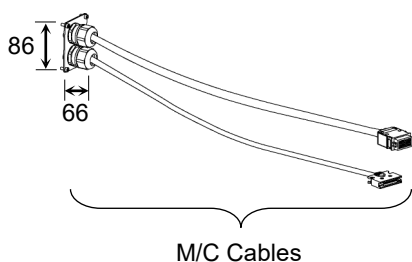

Do not remove the M/C cables from the Manipulator.



NOTE





For environmental conditions regarding space when placing the Controller on the base table, refer to the Robot Controller manual.

When using the Manipulator in the cleanroom, follow the steps below before the installation.

- (1) Unpack the Manipulator outside of the cleanroom.
- (2) Secure the Manipulator to delivery equipment such as a pallet with bolts so that the Manipulator does not fall over.
- (3) Wipe off the dust on the Manipulator with a little alcohol or distilled water on a lint-free cloth.
- (4) Transport the Manipulator into the cleanroom.
- (5) Secure the Manipulator to the base table.

### 3.5 Connecting the Cables

 WARNING	<ul style="list-style-type: none"> <li>■ Before performing any replacement procedure, turn OFF the Controller and related equipment, and then disconnect the power plug from the power source. Performing any replacement procedure with the power ON is extremely hazardous and may result in electric shock and/or malfunction of the robot system.</li> <li>■ Be sure to connect the AC power cable to a power receptacle. DO NOT connect it directly to a factory power source. To shut off power to the robot system, disconnect the power plug from the power source. Performing any work while connecting the AC power cable to a factory power source is extremely hazardous and may result in electric shock and/or malfunction of the robot system.</li> <li>■ Be sure to connect the cables properly. Do not allow unnecessary strain on the cables. (Do not put heavy objects on the cables. Do not bend or pull the cables forcibly.) The unnecessary strain on the cables may result in damage to the cables, disconnection, and/or contact failure. Damaged cables, disconnection, or contact failure is extremely hazardous and may result in electric shock and/or improper function of the robot system.</li> <li>■ Before wiring, turn OFF the Controller and related equipment, and then pull up a warning sign (e.g. DO NOT TURN ON THE POWER.). Wiring with the power ON is extremely hazardous and may result in electric shock and/or malfunction of the robot system.</li> <li>■ Grounding the Manipulator is done by connecting with the Controller. However, it is recommended to use the grounding hole on the base to ground directly for more secure grounding. If the ground wire is improperly connected to ground, it may result in the fire or electric shock.</li> <li>■ When connecting / replacing the brake release unit or the external short connector, turn OFF the power to the Controller and the brake release unit. Inserting and removing the connector while the power is ON may result in electrical shock.</li> </ul>
--	--

 CAUTION	<ul style="list-style-type: none"> <li>■ When connecting the Manipulator and the Controller, make sure that the serial numbers on each equipment match. Improper connection between the Manipulator and Controller may not only cause improper function of the robot system but also safety problems. The connection method varies with the Controller used. For details on the connection, refer to the Robot Controller manual.</li> <li>■ Only authorized or certified personnel should be allowed to perform wiring. Wiring by unauthorized or uncertified personnel may result in bodily injury and/or malfunction of the robot system.</li> <li>■ If the Manipulator is operated without connecting the brake release unit or the external short connector, the brakes cannot be released and it may cause damage on them. After using the brake release unit, be sure to connect the external short connector to the Manipulator, or check connection of the connector for the brake release unit.</li> </ul>
--	--

Cleanroom-model Manipulator

For the Cleanroom-model, an exhaust system is necessary. For details, refer to *Setup & Operation: 2.6 Specifications*.

Protection-model Manipulator

For the Protection-model, also make sure to follow the following precautions.

 CAUTION	<ul style="list-style-type: none"> <li>■ When operating the Manipulator under special environmental conditions (adverse conditions with dust and oily smoke), do not place the Controller in the same condition since the Controller does not comply with IP67. Doing so may cause equipment damage to and/or malfunction of the Controller.</li> <li>■ After using the brake release unit, be sure to reconnect the external short connector to the Manipulator. The brake release unit is not certified with the protection rating (IP67).</li> </ul>
--	---

M/C Cable Connection method

Connect the power connector and the signal connector of the M/C cables to the Controller.

Grounding

 WARNING	<ul style="list-style-type: none"> <li>■ Ground resistance must be 100 Ω or less. Improper ground resistance may result in fire and/or electric shock.</li> <li>■ Do not use the ground line for the Manipulator in common with other ground lines or grounding electrodes for other electric power, motor power, welding devices, etc. Using the ground line for the Manipulator in common with other ground lines or grounding electrodes may result in electric shock and/or malfunction of the robot system.</li> <li>■ When using metal ducts, metallic conduits, or distributing racks for cable, ground in accordance with national and local electric equipment technical standards. Grounding that does not meet the standards may result in electric shock and/or malfunction of the robot system.</li> </ul>
--	---

Follow local regulations for grounding. It is recommended that the core size of the grounding wire be 5.5 mm<sup>2</sup> or more.

Directly connect the ground line to the Manipulator as shown in the figure below.

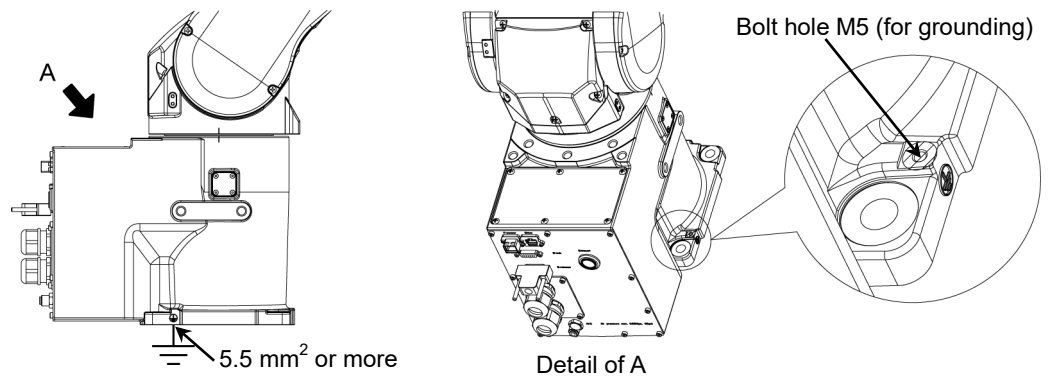

### 3.6 User Wires and Pneumatic Tubes

 <b>CAUTION</b>	<p>■ Only authorized or certified personnel should be allowed to perform wiring. Wiring by unauthorized or uncertified personnel may result in bodily injury and/or malfunction of the robot system.</p>
---	--

User electrical wires and pneumatic tubes are contained in the cable unit.

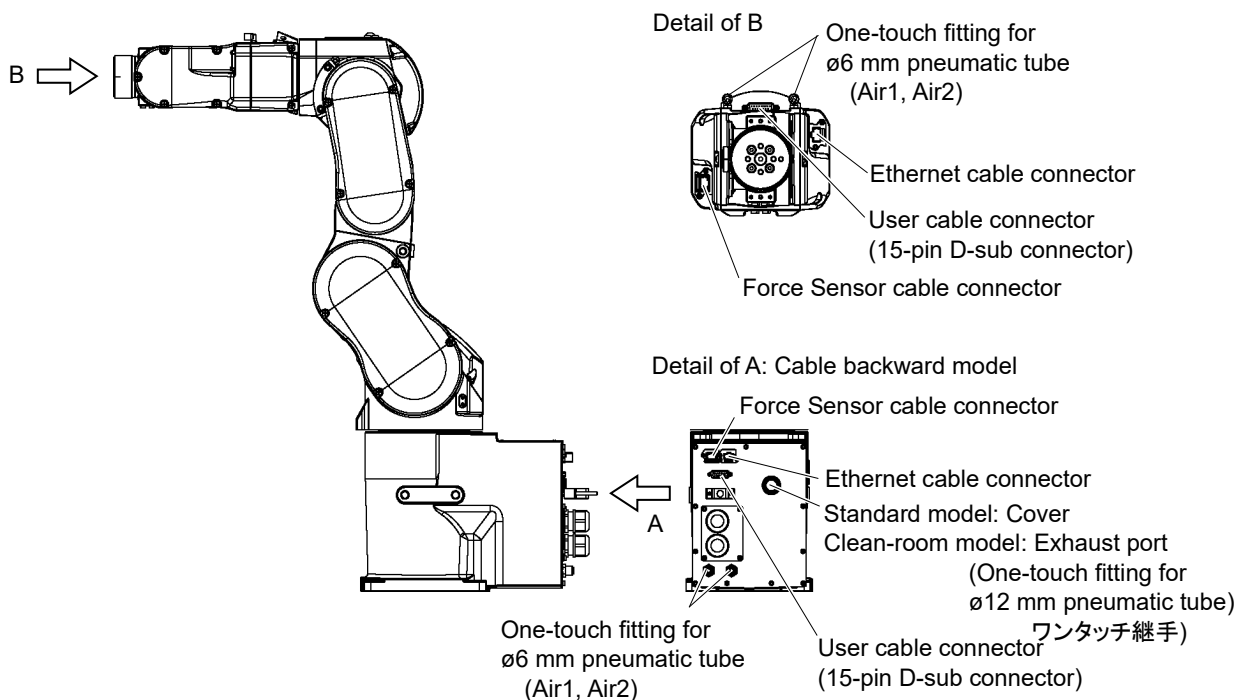

(Figure: C8-A701\* (C8))

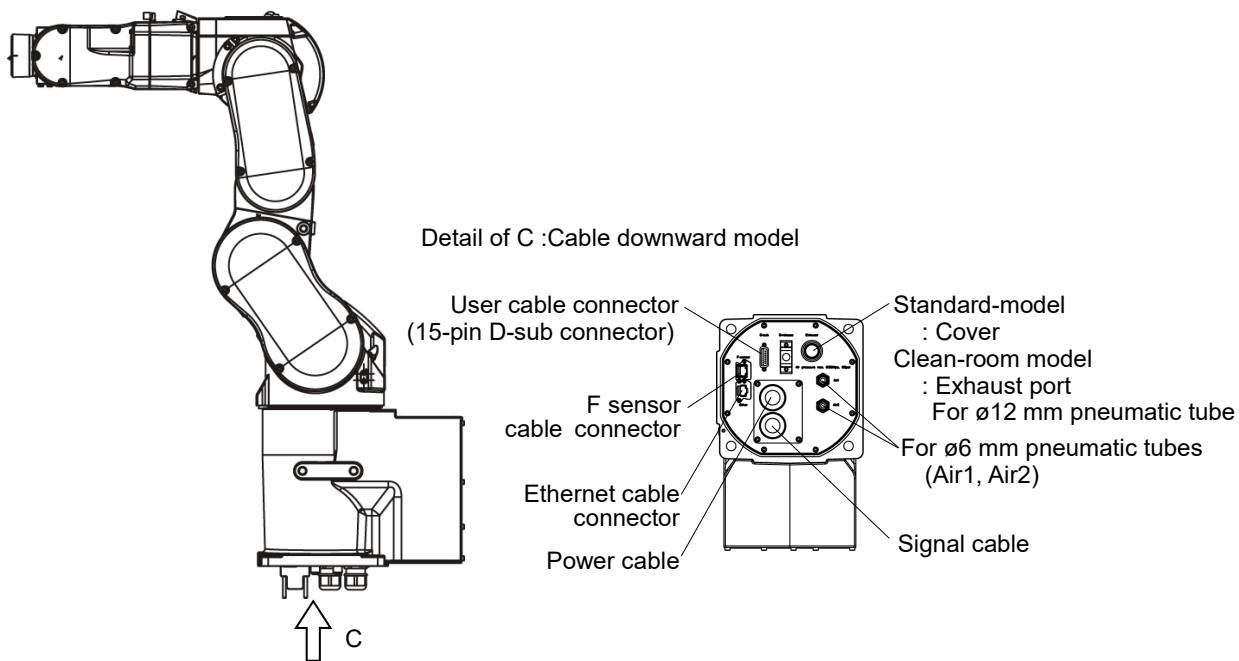

(Figure: C8-A701\*B (C8))

## Electrical wires

### Specifications of the user wires D-sub 15-pin

Rated Voltage	Allowable Current	Wires	Nominal Sectional Area	Note
AC/DC30 V	1 A	15	0.106 mm <sup>2</sup>	Shielded

Pins with the same number, indicated on the connectors on both ends of the cables, are connected.

### Attached connector for the user wires (standard-model, cleanroom-model)

		Maker	Standard	
15 pin	Connector	JAE	DA-15PF-N	(Solder type)
	Clamp Hood	HRS	HDA-CTH(4-40)(10)	(Connector setscrew: #4-40 UNC)

Two parts are attached for each.

### Attached connector for the user wires (protection-model)

		Maker	Standard	
15 pin	Connector	HARTING	09 67 015 5615	(Solder type)
	Clamp Hood	HARTING	09 67 015 0538	(Connector setscrew: #4-40 UNC)

Two parts are attached for each.

### 8 pin (RJ45) Cat.5e or equivalent

For the standard and cleanroom model Manipulators, commercially available Ethernet cables can be used.

For the protection-model, use the following optional part.

User connector kit (IP67 waterproof, for RJ45, 2 pcs)

For details, refer to *Setup & Operation 6. Option*.

### Other

The 6-pin cable for the F sensor option is included.

**Pneumatic tubes**

Max. Usable Pneumatic Pressure	Pneumatic Tubes	Outer Diameter × Inner Diameter
0.59 MPa (6 kgf/cm <sup>2</sup> : 86 psi)	2	ø6 mm × ø4 mm

**Standard model, Cleanroom model**

The elbow fitting is attached on the Arm #4 at the time of shipment. The part can be replaced with the straight fitting (accessory) according to application.

**Protection model**

The plugs are installed on the Arm #4 and the base. To use the air tubes, remove the plugs and install the fittings (accessory) on the Arm #4.

Screw hole size for installing the Arm #4 fitting: M6

For the protection-model, see the following precautions as well.



CAUTION

- Be sure to use IP67 compliant wires and tubes when using the Manipulator under special environmental conditions (adverse condition with dust and oily smoke). Using unprotected wires and tubes may cause equipment damage to and/or malfunction of the Manipulator as proper operation of the Manipulator under the conditions is no more guaranteed.
- Be sure to attach the cap or plug (attached at the time of shipment) on the user cable connector when not using the connector. Using the Manipulator without the cap or plug may cause equipment damage to and/or malfunction of the Manipulator as dust or oily smoke gets into the connector.

### 3.7 Checking the Basic orientation

After parts have been replaced (motors, reduction gear units, belts, etc.), the Manipulator cannot operate properly because a gap exists between the origin positions stored in each motor and these stored in the Controller. The process to compensate the position gap is called “Calibration”.

At the time of shipment, the basic orientation of the Manipulator shown below is set as the origin position.

After installing the Manipulator and setup the operating environment, move the Manipulator to the origin position and check if it moves to the basic position properly.

To make the Manipulator move to the origin position, select [Tool]-[Robot Manager] - [Control Panel] and click <Home>.

If the gap still exists and the Manipulator cannot be in the basic orientation after the calibration, please contact the supplier of your region.

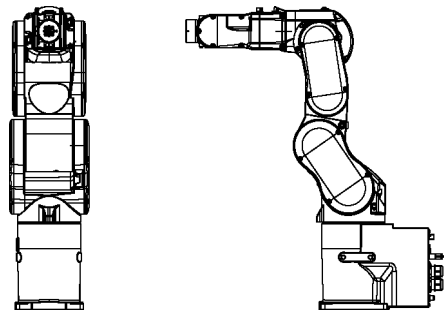

Basic orientation

(Figure: C8-A701\*\* (C8))

## 4. End Effectors

### 4.1 Attaching an End Effector

Create an end effector for your Manipulator. Flange dimensions of the wrist attached to the end of Arm #6 is as below.

 <b>CAUTION</b>	<p>■ If you use an end effector equipped with a gripper or chuck, connect wires and/or pneumatic tubes properly so that the gripper does not release the work piece when the power to the robot system is turned OFF. Improper connection of the wires and/or pneumatic tubes may damage the robot system and/or work piece as the work piece is released when the Emergency Stop switch is pressed. I/O outputs are configured at the factory so that they are automatically shut off (0) by power disconnection, the Emergency Stop switch, or the safety features of the robot system.</p>
---	---

#### Wrist Flange

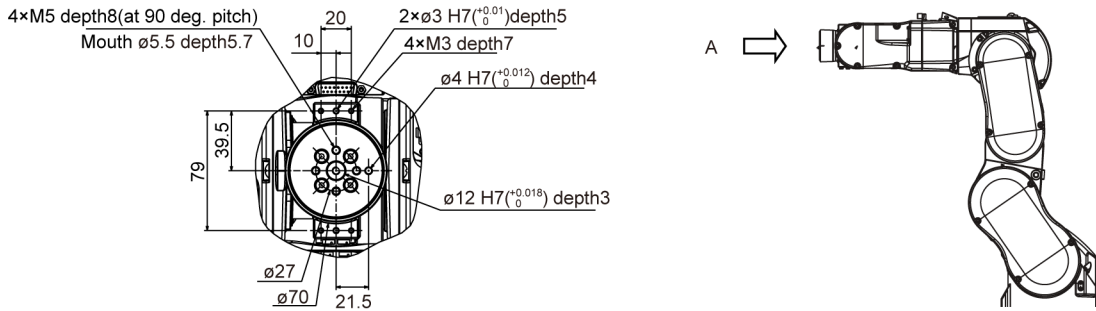

#### Arm #6

Attach an end effector to the end of the Arm #6 using the M5 bolts.

#### Layouts

When you operate the Manipulator with an end effector, the end effector may interfere with the Manipulator body depending on the outer diameter of the end effector, the size of the work piece, or the position of the arms. When designing your system layout, pay close attention to the interference area of the end effector.

#### Compatibility with ISO flange:

To install the end effector whose mounting dimensions are designed for the ISO flange, we provide the optional C8 ISO flange (J6). For details, refer to *Setup & Operation: 6. Options*.

### 4.2 Attaching Camera and Air Valves

Decks are equipped to Arms #3 and #5 to enable the easy installation of air valve.

To mount the camera, the camera plate unit is necessary.

We provide the optional Camera Plate Unit. For details, refer to *Setup & Operation: 6. Options*.



C8-A701\*\*\* (C8)

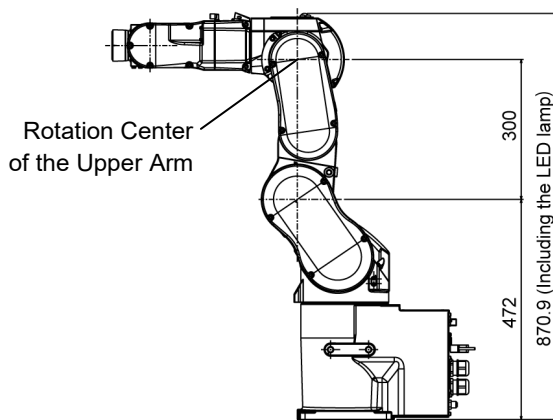
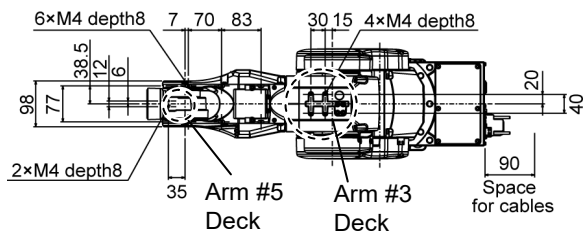

C8-A901\*\*\* (C8L)

[Unit: mm]

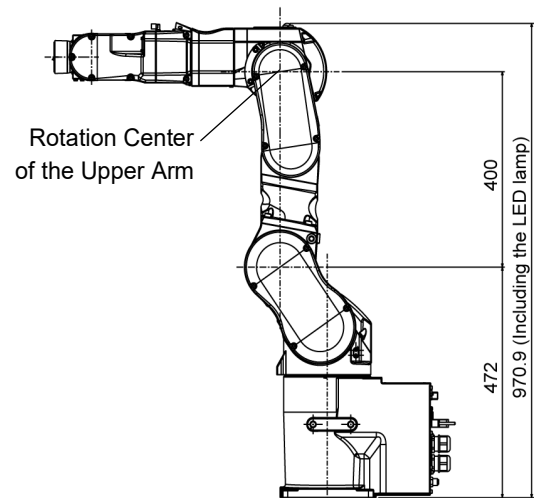
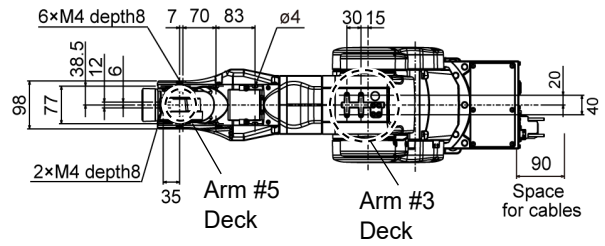

C8-A1401\*\*\* (C8XL)

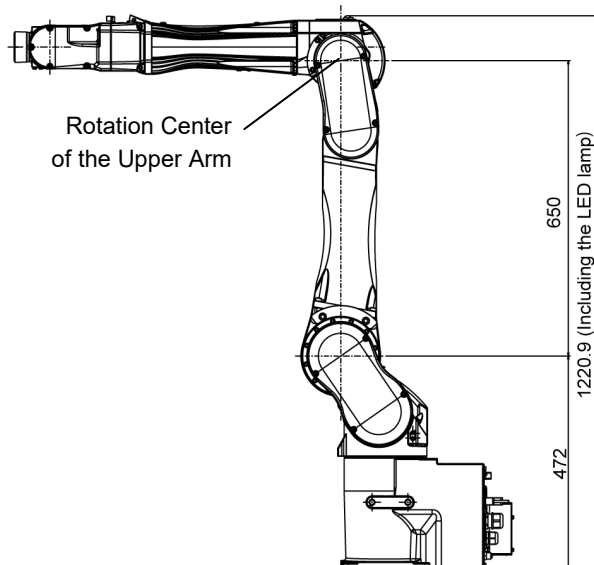
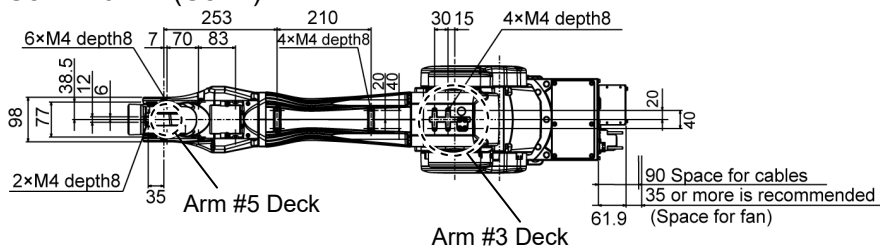

### 4.3 WEIGHT and INERTIA Settings

The WEIGHT and INERTIA (inertia moment and eccentricity) commands are for setting the load parameters of the Manipulator. These settings optimize the Manipulator motion.

#### WEIGHT Setting

The WEIGHT command is for setting the load weight. The more the load weight increases, the more the speed and acceleration/deceleration are reduced.

#### INERTIA Setting

The INERTIA command is for setting the inertia moment and the eccentricity of the load. The more the inertia moment increases, the more the acceleration and deceleration of the Arm #6 are reduced. The more the eccentricity increases, the more the acceleration and deceleration for the Manipulator movement are reduced.

To ensure optimum Manipulator performance, make sure that the load (weight of the end effector and work piece) and inertia moment of the load are within the maximum rating for the Manipulator, and that Arm #6 does not become eccentric.

If the load or the inertia moment exceeds the ratings or if the load becomes eccentric, follow the steps in the *Setup & Operation 4.3.1 WEIGHT Setting* and *4.3.2 INERTIA Setting*, to set parameters.

Setting parameters makes the operation of the Manipulator optimal, reduces vibration to shorten the operating time, and improves the capacity for larger loads. In addition, it reduces persistent vibration produced when the inertia moment of the end effector and work piece is bigger.

The allowable load for C8 series Manipulators is 8 kg at the maximum.

Due to the limitations of the moment and inertia moment shown in the table below, the load (end effector weight + work piece weight) should also meet these conditions.

#### Allowable Load

Joint	Allowable Moment	GD <sup>2</sup> /4 Allowable Moment of Inertia
#4	16.6 N·m (1.69 kgf·m)	0.47 kg·m <sup>2</sup>
#5	16.6 N·m (1.69 kgf·m)	0.47 kg·m <sup>2</sup>
#6	9.4 N·m (0.96 kgf·m)	0.15 kg·m <sup>2</sup>

#### Moment

The moment indicates amount of torque applied on the joint in order to support the gravity on the load (end effector + work piece).

The moment increases as weight of the load and amount of eccentricity increase. As this also increases the load applied on the joint, make sure to keep the moment within the allowable value.

#### Inertia moment

The inertia moment indicates how difficult the load (end effector + work piece) to rotate when the Manipulator joint starts to rotate (amount of inertia). The inertia moment increases as weight of the load and amount of eccentricity increase. As this also increase the load applied on the joint, make sure to keep the inertia moment within the allowable value.

The moment  $M$  (Nm) and inertia moment  $I$  ( $\text{kgm}^2$ ) when the volume of the load (end effector + work piece) is small can be obtained by the following formula.

$$M \text{ (Nm)} = m(\text{kg}) \times L \text{ (m)} \times g \text{ (m/s}^2\text{)}$$

$$I \text{ (kgm}^2\text{)} = m(\text{kg}) \times L^2 \text{ (m)}$$

$m$  : Weight of load (kg)

$L$  : Eccentric quantity of load (m)

$g$  : Gravitational acceleration ( $\text{m/s}^2$ )

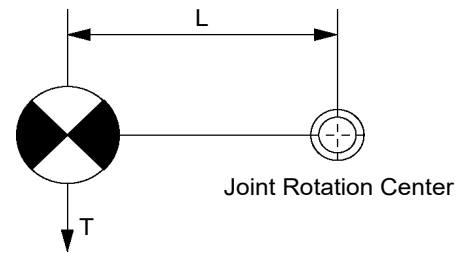

The figure below shows distribution of the center of gravity when the volume of the load (end effector + work piece) is small.

Design the end effector so that the center of gravity is within the allowable moment.

If the volume of the load is large, calculate the moment and inertia moment by referring to *Setup & Operation 4.3.2 INERTIA setting - Calculating the Inertia Moment.*

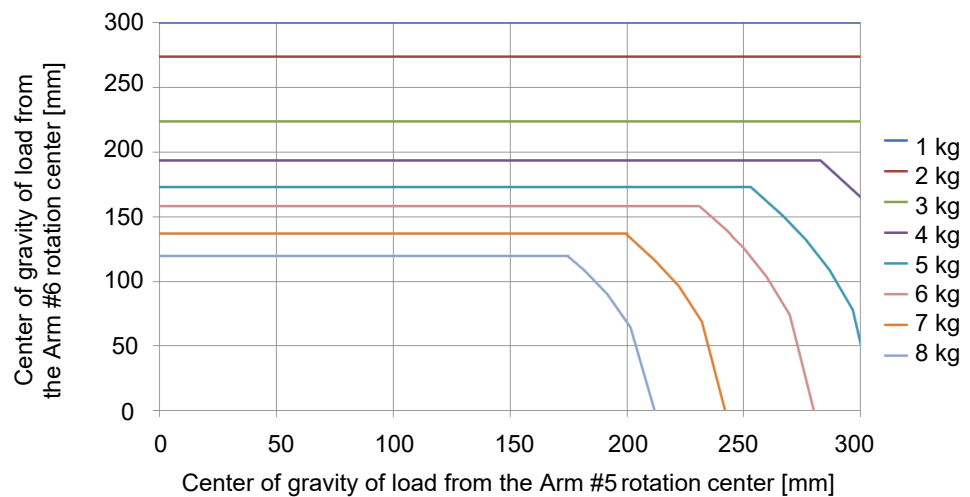

#### Max. Eccentric Quantity of Load

(Distance between the joint rotation center and the load's center of gravity)

Joint	1 kg	2 kg	3 kg	4 kg	5 kg	6 kg	7 kg	8 kg
#4	300 mm	300 mm	300 mm	300 mm	300 mm	280 mm	242 mm	212 mm
#5	300 mm	300 mm	300 mm	300 mm	300 mm	280 mm	242 mm	212 mm
#6	300 mm	274 mm	224 mm	194 mm	173 mm	158 mm	137 mm	120 mm

When calculating the critical dimension of the load using the allowable moment and inertia moment, the calculated value represents a distance from the Arm #5 rotation center, not the distance from the flange. To calculate the distance from the flange to the load's center of gravity, subtract the distance from the center of the Arm #5 rotation center to the flange (=80 mm) as shown in the example below.

Example: Calculation of the critical dimension of the load (a) when the load is 8 kg.

Center of gravity by the allowable moment control:

$$16.6 \text{ N}\cdot\text{m}/(8 \text{ kg}\times 9.8 \text{ m/s}^2) = 0.212 \text{ m} = 212 \text{ mm}$$

Center of gravity by the allowable inertia moment control:

$$(0.47 \text{ kgm}^2/8 \text{ kg})^{1/2} = 0.242 \text{ m} = 242 \text{ mm}$$

Due to the allowable moment control, center of gravity for the load limit is 212 mm from the Arm #5 rotation center.

Distance from the flange to the center of gravity for the load limit

$$a = 212 \text{ mm} - 80 \text{ mm} = 132 \text{ mm}$$

### Critical Dimension of Load

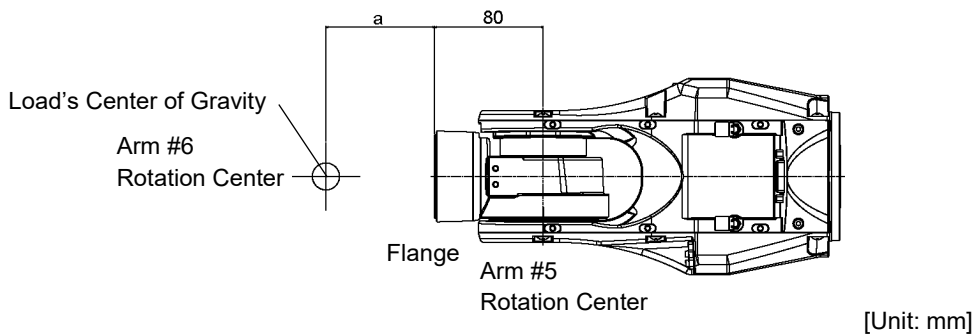

### 4.3.1 WEIGHT setting



- Set the total weight of the end effector and the work piece smaller than the maximum payload. The C8 series Manipulators can operate without limitations on the condition unless and until the load exceeds this maximum payload. Always set the Weight parameters of the WEIGHT command according to the load. Setting a value that is smaller than the actual load may cause errors, excessive shock, insufficient function of the Manipulator, and/or shorten the life cycle of parts/mechanisms.

The acceptable weight capacity (end effector and work piece) for C8 series Manipulators is as follows:

Rated	Maximum
3 kg	8 kg

Change the setting of the Weight parameter according to the load.

After changing the Weight parameter setting, the maximum acceleration/deceleration and speed of the robot system corresponding to the load is set automatically.

#### Setting method of Weight parameters



Select [Tools]-[Robot Manager]-[Weight] panel and set the value in [Weight:]. You may also execute the Weight command from [Command Window].

Load on the Manipulator  
Mounting location of the load

C8-A701\*\*\* (C8)  
Load on the fore end of Arm #6

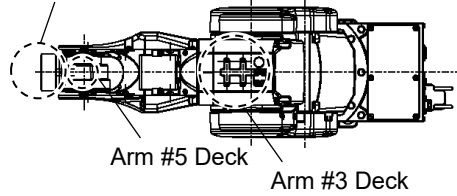

C8-A901\*\*\* (C8L)  
Load on the fore end of Arm #6

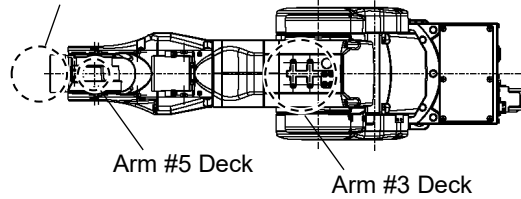

C8-A1401\*\*\* (C8XL)  
Load on the fore end of Arm #6

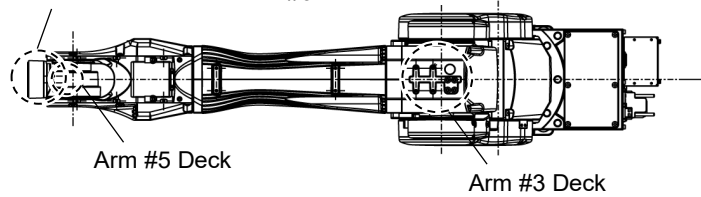

Details of the deck

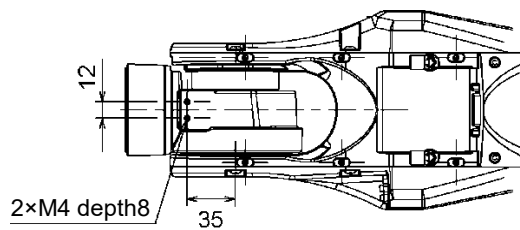

Arm #5 Deck

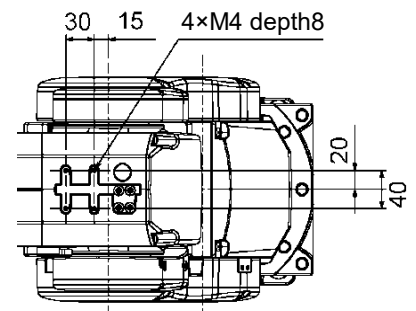

Arm #3 Deck

[Unit: mm]

When you attach the equipment to the decks on the upper arm, convert its weight into equivalent weight assuming that the equipment is attached to the end of the Arm #6. Then, this equivalent weight added to the load will be a Weight parameter.

Calculate the Weight parameter by using the formula below and enter the value.

**Weight Parameter Formula**

Weight parameter =  $M_w + W_a + W_b$

$M_w$  : Load on the fore end of Arm #6 (kg)  
 $W_a$  : Equivalent weight of the Arm #3 deck (kg)  
 $W_b$  : Equivalent weight of the Arm #5 deck (kg)

$W_a = M_a (L_a)^2 / (L)^2$   
 $W_b = M_b (L_b)^2 / (L)^2$

$M_a$  : Weight of the air valve on the Arm #3 deck  
 $M_b$  : Weight of the camera on the Arm #5 deck  
 $L$  : Length of the upper arm (315 mm)  
 $L_a$  : Distance between the Joint #3 and the center of gravity of the air valve on the Arm #3 deck (mm)  
 $L_b$  : Distance between the Joint #3 and the center of gravity of the camera on the Arm #5 deck (mm)

<Example> The fore end of the Arm #6 is 730 mm (L) away from the Joint #3 of C8-A1401\*\*\* (C8XL).

Load on the fore-end of Arm #6 is 5 kg ( $M_w$ ).

Load on the Arm #3 deck is 1.5 kg ( $M_a$ ).

The deck is 0 mm ( $L_a$ ) away from Joint #3.

Load on the Arm #5 deck is 1.0 kg ( $M_b$ ).

The deck is 690 mm ( $L_b$ ) away from the Joint #3.

$$W_a = 1.5 \times 0^2 / 730^2 = 0$$

$$W_b = 1.0 \times 690^2 / 730^2 = 0.89 \rightarrow 0.9 \text{ (round up)}$$

$$M_w + W_a + W_b = 5 + 0 + 0.9 = 5.9$$

Enter “5.9” for the Weight parameter.

Automatic speed setting by Weight parameter

The percentages in the graphs are based on the speed at rated weight (3 kg) as 100%.

C8-A701\*\*\*(C8)

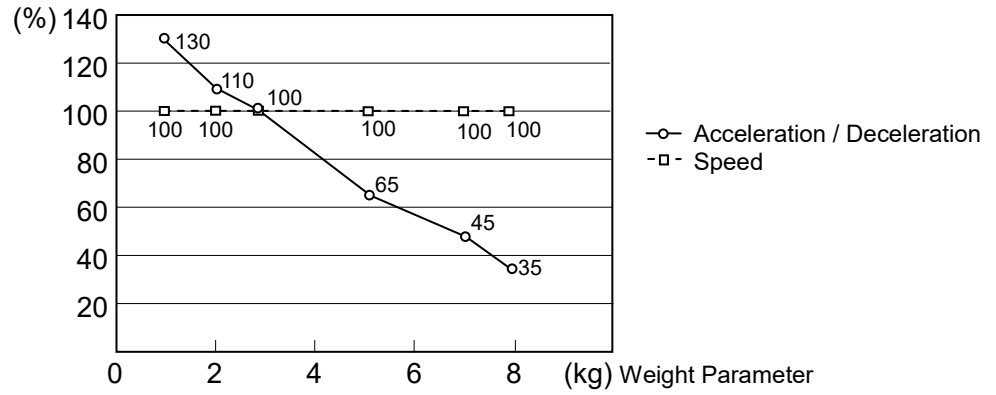

C8-A901\*\*\*(C8L)

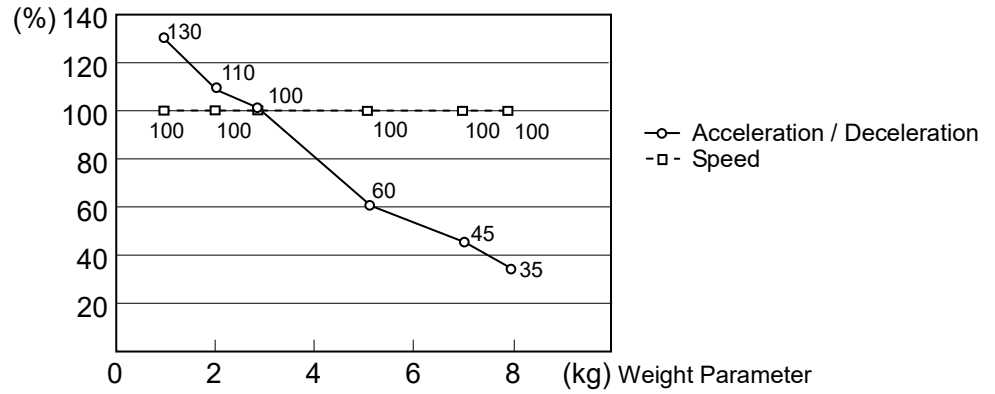

C8-A1401\*\*\*(C8XL)

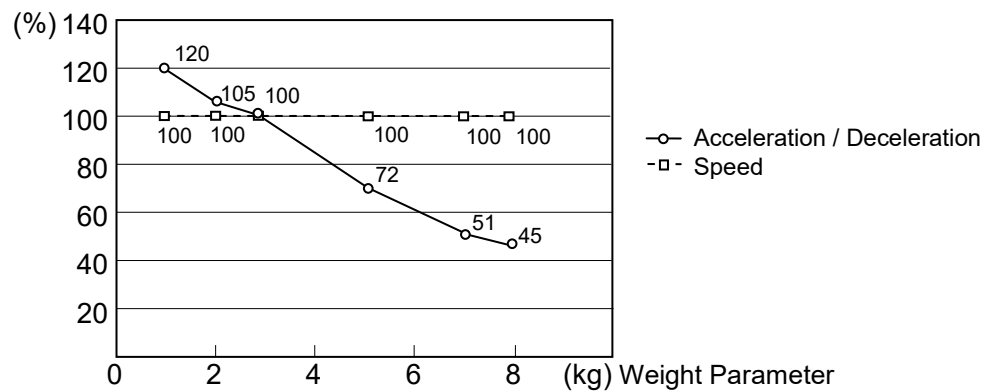

NOTE Maximum AccelS setting value varies depending on Weight setting value. For more details, refer to "Setup & Operation 2.6.1 Specification table".

### 4.3.2 INERTIA setting

#### Inertia Moment and the INERTIA Setting

The inertia moment is defined as “the ratio of the torque applied to a rigid body and its resistance to motion”. This value is typically referred to as “the moment of inertia”, “inertia”, or “GD<sup>2</sup>”. When the Manipulator operates with objects such as an end effector attached to the Arm #6, the moment of inertia of load must be considered.

 CAUTION	<ul style="list-style-type: none"> <li>■ The inertia moment of the load (weight of the end effector and work piece) must be 0.15 kg·m<sup>2</sup> or less. The C8 series Manipulators are not designed to work with inertia moment exceeding 0.15 kg·m<sup>2</sup>. Always set the inertia moment (INERTIA) parameter according to the inertia moment. Setting a value that is smaller than the actual inertia moment may cause errors, excessive shock, insufficient function of the Manipulator, and/or shorten the life of parts/mechanisms.</li> </ul>
--	--

The acceptable inertia moment of load for C8 series Manipulators is 0.03 kg·m<sup>2</sup> nominal rating and 0.15 kg·m<sup>2</sup> maximum. Change the setting of the inertia moment according to the inertia moment of the load using the INERTIA command. After the setting has been changed, the maximum acceleration/deceleration speed of Arm #6 responding to “inertia moment” is set automatically.

#### Inertia moment of load on Arm #6

The inertia moment of the load (weight of the end effector and work piece) on the Arm #6 can be set by the “inertia moment (INERTIA)” parameter of the INERTIA command.

EPSON  
RC+

Select [Tools]–[Robot Manager]–[Inertia] panel and enter the value in [Load inertia:]. You may also execute the Inertia command from [Command Window].



## Eccentric Quantity and the INERTIA Setting



- The eccentric quantity of the load (weight of the end effector and work piece) must be 300 mm or less. The C8 series Manipulators are not designed to work with eccentric quantity exceeding 300 mm. Always set the eccentric quantity parameter according to the eccentric quantity. Setting a value that is smaller than the actual eccentric quantity may cause errors, excessive shock, insufficient function of the Manipulator, and/or shorten the life cycle of parts/mechanisms.

The acceptable eccentric quantity of the load for C8 series Manipulators is 50 mm at nominal rating and 300 mm at maximum. When the eccentric quantity of the load exceeds the rating, change the setting of eccentric quantity parameter using the INERTIA command. After changing the setting, the maximum acceleration/deceleration speed of Manipulator corresponding to “eccentric quantity” is set automatically.

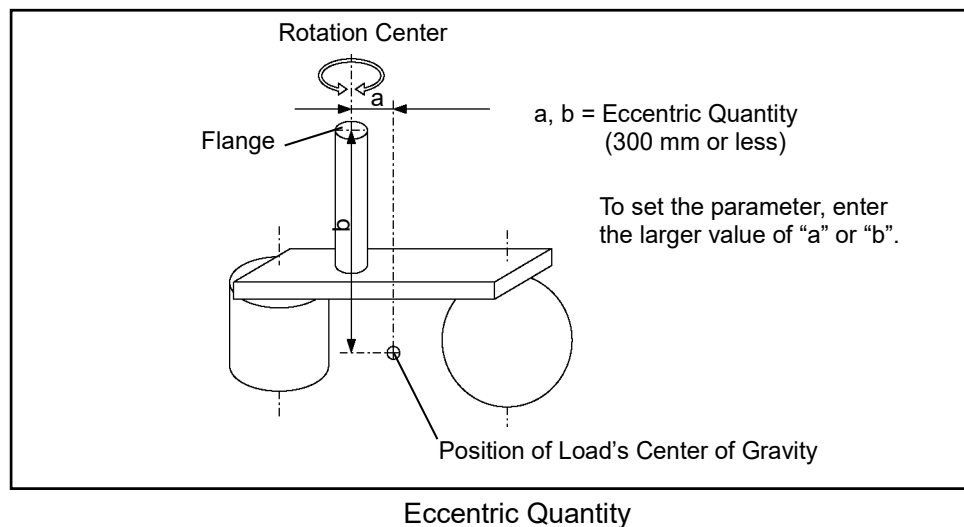

## Eccentric quantity of load on Arm #6

The eccentric quantity of the load (weight of the end effector and work piece) on the Arm #6 can be set by the “eccentric quantity” parameter of the INERTIA command. Enter the larger value of either “a” or “b” in the figure above to [Eccentricity].



Select [Tools]–[Robot Manager]–[Inertia] panel and enter the value into [Eccentricity:]. You may also execute the Inertia command from [Command Window].

Automatic acceleration/deceleration setting by INERTIA (eccentric quantity)

Automatic setting by inertia moment setting (common to C8 series)

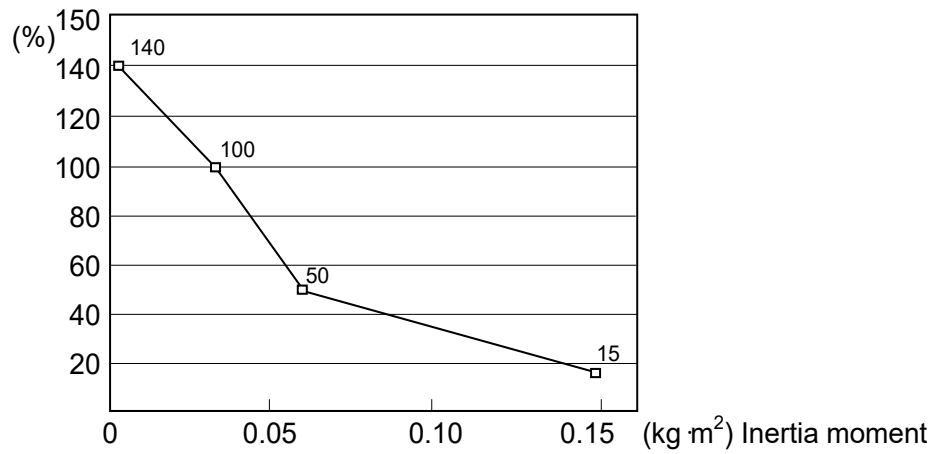

\* The percentage in the graph is based on the acceleration/ deceleration at rated eccentricity (0.03 kg·m<sup>2</sup>) as 100%.

Automatic setting by eccentricity setting (common to C8 series)

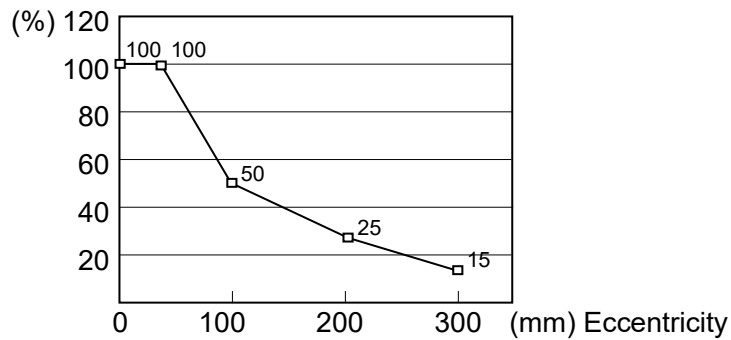

\* The percentage in the graph is based on the acceleration/ deceleration at rated eccentricity (50 mm) as 100%.

### Calculating the Inertia Moment

Refer to the following example formulas to calculate the inertia moment of the load (end effector with work piece).

The inertia moment of the entire load is calculated by the sum of (a), (b), and (c).

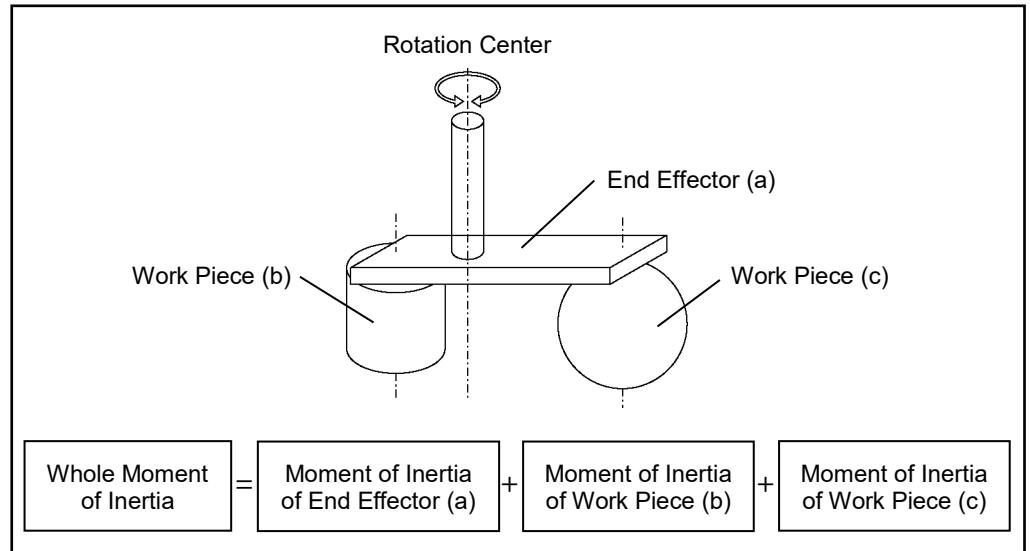

The methods for calculating the inertia moment for (a), (b), and (c) are shown in this and the next page. Figure out the whole inertia moment using the basic formulas below.

#### (a) Inertia moment of a rectangular parallelepiped

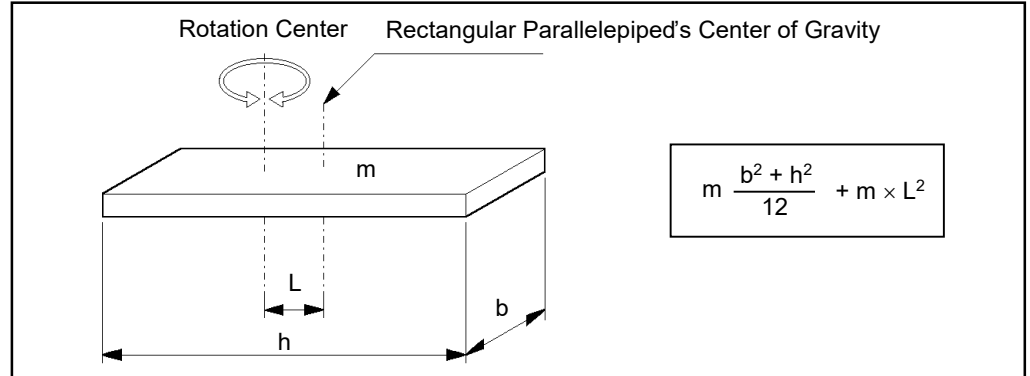

#### (b) Inertia moment of a cylinder

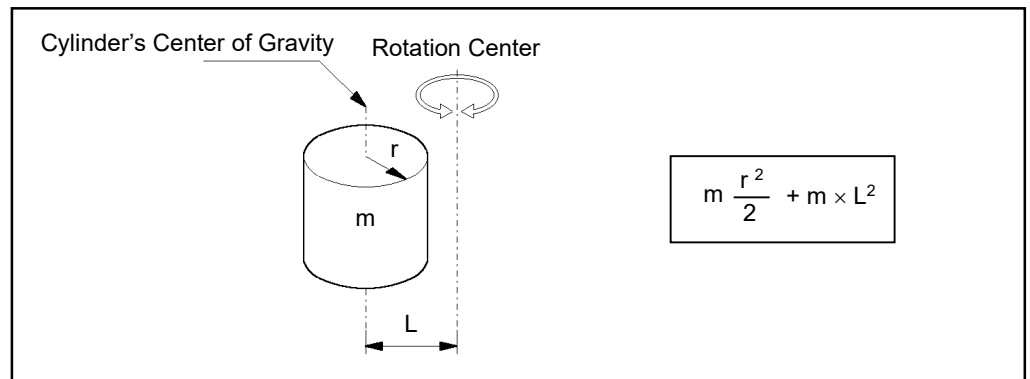

(c) Inertia moment of a sphere

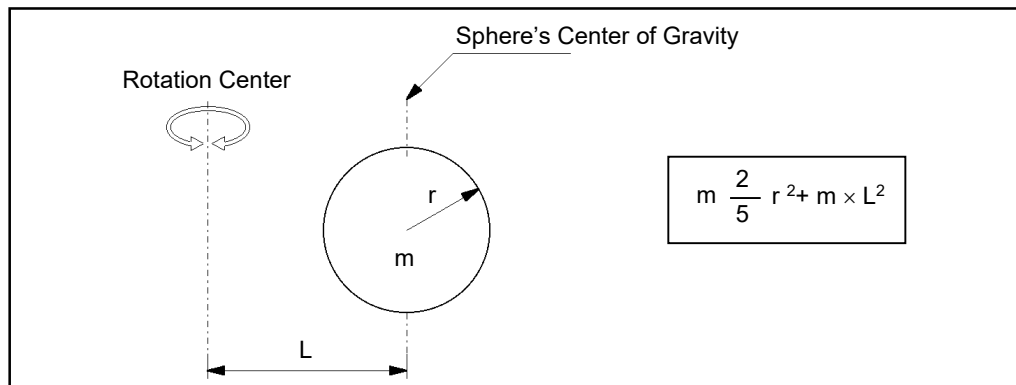

## 4.4 Precautions for Auto Acceleration/Deceleration

The speed and acceleration/deceleration of the Manipulator motion are automatically optimized according to the values of WEIGHT and INERTIA and the Manipulator's postures.

### WEIGHT Setting

The speed and acceleration/deceleration of the Manipulator are controlled according to the load weight set by the WEIGHT command.

The more the load weight increases, the more the speed and acceleration/deceleration are reduced to prevent residual vibration.

### INERTIA Setting

The acceleration/deceleration of Arm #6 are controlled according to the inertia moment set by the INERTIA command. The acceleration/deceleration of the whole Manipulator are controlled according to the eccentricity set by the INERTIA command. The more the inertia moment and eccentricity of the load increase, the more the acceleration/deceleration are reduced.

### Auto Acceleration/Deceleration According to Manipulator's Posture

The acceleration/deceleration are controlled according to the Manipulator's posture. When the Manipulator extends its arms or when the movement of the Manipulator produces vibration frequently, the acceleration/deceleration are reduced.

Set appropriate values for WEIGHT and INERTIA so that the Manipulator operation is optimized.

## 5. Motion Range



■ When limiting the motion range for safety, be sure to set by both the pulse range and mechanical stops. Failure to do so may cause serious safety problems.

The motion range is preset at the factory as describes in the *Setup & Operation 2.5 Standard Motion Range*. This is the maximum motion range of the Manipulator.

Motion range is set by the following three methods:

1. Setting by pulse range (for all arms)
2. Setting by mechanical stops
3. Setting the Cartesian (rectangular) range in the X, Y coordinate system of the Manipulator

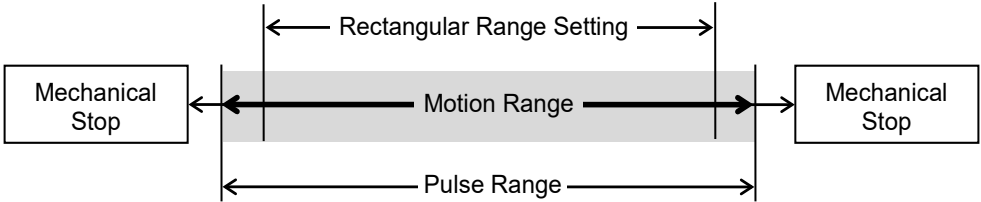

When the motion range is changed due to layout efficiency or safety, follow the descriptions in 5.1 through 5.4 to set the range.

### 5.1 Motion Range Setting by Pulse Range (for Each Joint)

Pulses are the basic unit of Manipulator motion. The motion range of the Manipulator is controlled by the pulse range (the lower limit and the upper limit) of each axis.

Pulse values are read from the encoder output of the servo motor.

The pulse range should be set within the mechanical stop range.



NOTE The Arm #1 and #4 do not have a mechanical stop.



NOTE Once the Manipulator receives an operating command, it checks whether the target position specified by the command is within the pulse range before operating. If the target position is out of the set pulse range, an error occurs and the Manipulator does not move.



The pulse range can be set in [Tools]-[Robot manager]-[Range] panel. You may also execute the Range command from the [Command Window].

### 5.1.1 Max. Pulse Range of Joint #1

Pulse values in counterclockwise direction are positive (+) and values in clockwise direction are negative (-).

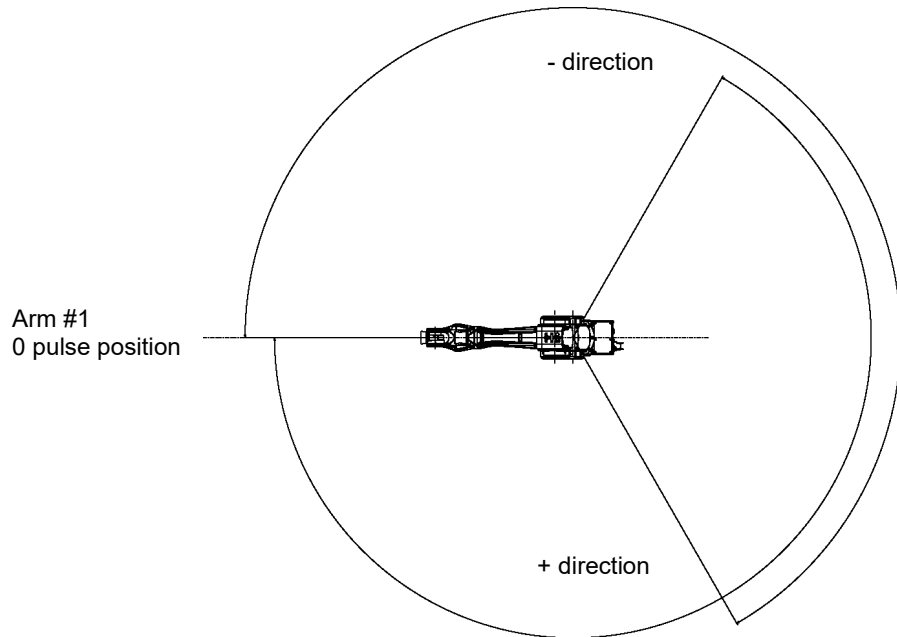

	C8-A701*** (C8)	C8-A901*** (C8L)	C8-A1401*** (C8XL)
Angle (°)	± 240		
Pulse (pulse)	± 9507090	± 10695600	± 15736800

### 5.1.2 Max. Pulse Range of Joint #2

Pulse values in clockwise direction are positive (+) and values in counterclockwise direction are negative (-).

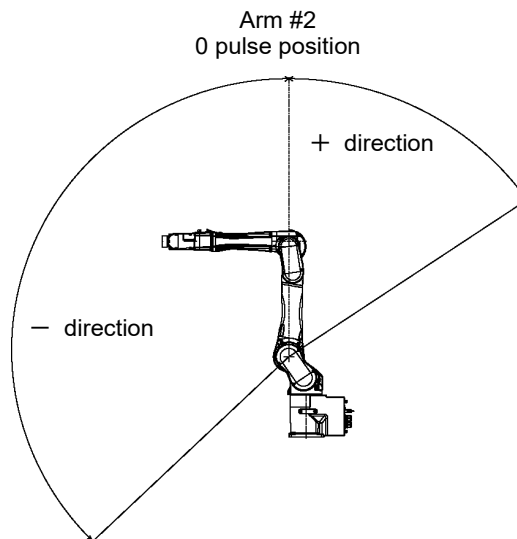

	C8-A701*** (C8)	C8-A901*** (C8L)	C8-A1401*** (C8XL)
Angle (°)	- 158 to + 65		- 135 to + 55
Pulse (pulse)	- 6245685 to + 2569428	- 6903178 to + 2839915	- 10616940 to + 4325420

### 5.1.3 Max. Pulse Range of Joint #3

Pulse values in clockwise direction are positive (+) and values in counterclockwise direction are negative (-).

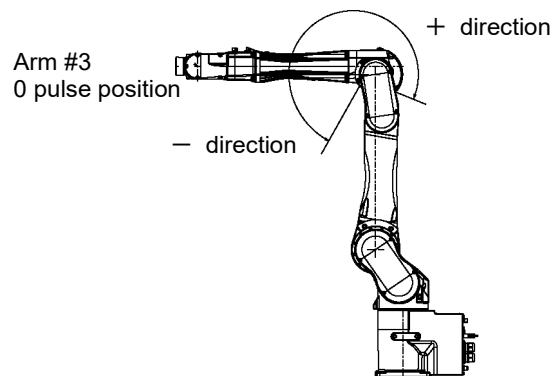

	C8-A701*** (C8)	C8-A901*** (C8L)	C8-A1401*** (C8XL)
Angle (°)	- 61 to + 202		
Pulse (pulse)	- 1776754 to + 5883677	- 2220949 to + 7354618	- 3997696 to + 13238272

### 5.1.4 Max. Pulse Range of Joint #4

From the angle of arm end, clockwise pulse values are positive (+) and counterclockwise pulse values are negative (-). The max. pulse range of the Arm #4 is common to C8 series Manipulators.

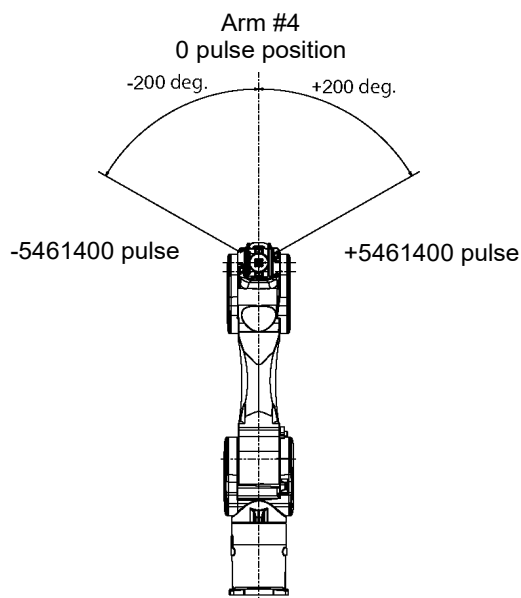

(deg.= °)



**5.1.5 Max. Pulse Range of Joint #5**

Pulse values in clockwise direction are positive (+) and values in counterclockwise direction are negative (-). The max. pulse range of the Arm #5 is common to C8 series Manipulators.

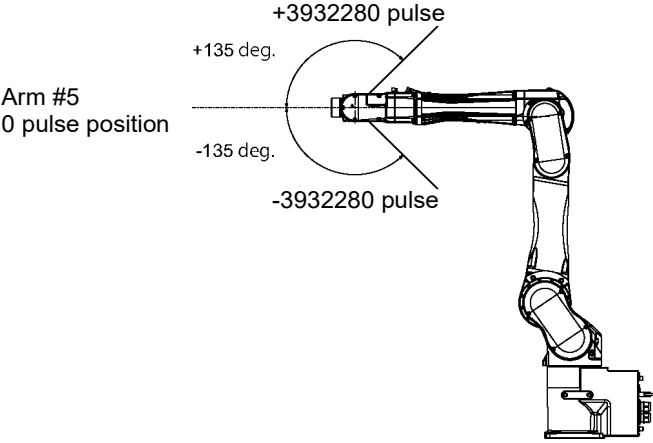

(deg.= °)

**5.1.6 Max. Pulse Range of Joint #6**

From the angle of arm end, clockwise pulse values are positive (+) and counterclockwise pulse values are negative (-). The max. pulse range of the Arm #6 is common to C8 series Manipulators.

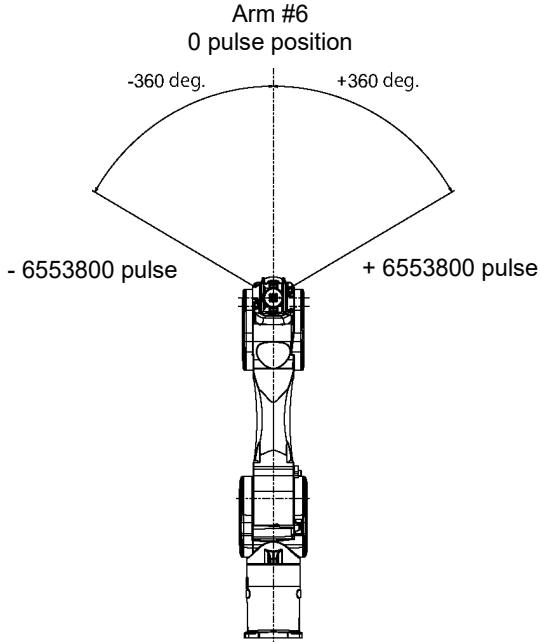

(deg.= °)

## 5.2 Motion Range Setting by Mechanical Stops

Using the adjustable mechanical stops physically limits the absolute area that the Manipulator can move.

Be sure to turn OFF the Manipulator in advance.

Use bolts conforming to the specified length and surface processing (ex: nickel plating) with high corrosion resistance.

Specify the pulse range again after changing the position of the mechanical stop.

For details on the pulse range setting, refer to the *Setup & Operation 5.1 Motion Range Setting by Pulse Range (for All Arms)*.

Be sure to set the pulse range not to exceed the setting angles of the mechanical stop.

### 5.2.1 Motion Range Setting of Joint #1

Install the adjustable mechanical stop (J1) to the threaded hole corresponding to the angle you want to set.

Normally the mechanical stop is not installed.

Hexagon socket head cap bolt M12×30×2 bolts  
Tightening torque 42.0 ± 2.1N·m (428 ± 21 kgf·cm)

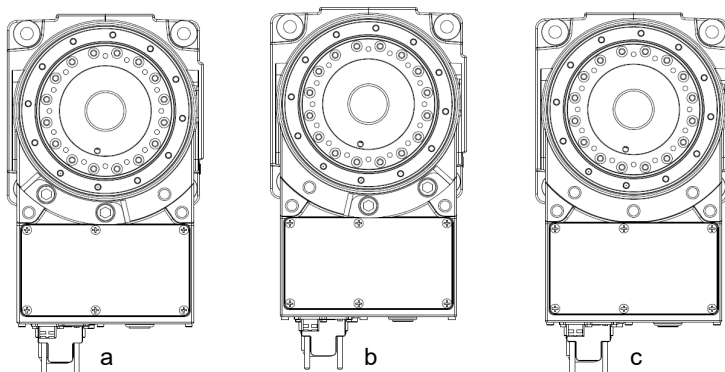

		a	b	c
Angle (°)		-145, +110	-110, +145	±240
Pulse (pulse)	C8-A701*** (C8)	-5743867 +4357416	-4357416 +5743867	±9507090
	C8-A901*** (C8L)	-6461925 +4902150	-4902150 +6461925	±10695600
	C8-A1401*** (C8XL)	-9507650 +7212700	-7212700 +9507650	±15736800
Adjustable mechanical stop (J1)		Applied	Applied	Not applied (standard)

**5.2.2 Motion Range Setting of Joint #2**

C8-A701\*\*\* (C8), C8-A901\*\*\* (C8L)

Remove the mechanical stop installed as standard and install the adjustable mechanical stop (C8/C8L\_J2). (Joint #2 standard motion range -158 to +65°)

Hexagon socket head cap bolt M10×35×1 bolt  
 Tightening torque 32.0 ± 1.6 N·m (326 ± 16 kgf·cm)

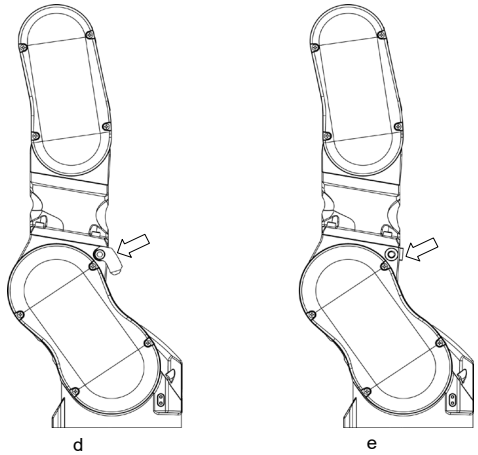

		d	e
Angle (°)		-158, +30	-158, +65
Pulse(pulse)	C8-A701*** (C8)	-6245685 +1185890	-6245685 + 2569428
	C8-A901*** (C8L)	-6903178 +1310730	-6903178 +2839915
Adjustable mechanical stop (C8/C8L_J2)		Applied	Applied (standard)

C8-A1401\*\*\* (C8XL)

Remove the mechanical stop installed as standard and install the adjustable mechanical stop (C8XL\_J2). (Joint #2 standard motion range -135 to +55°)

Hexagon socket head cap bolt M10×35×2 bolts  
 Tightening torque 32.0 ± 1.6 N·m (326 ± 16 kgf·cm)

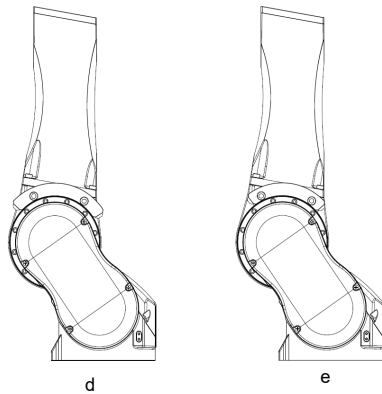

		d	e
Angle (°)		-125, +45	-135, +55
Pulse(pulse)	C8-A1401*** (C8XL)	-9830500 +3538980	-10616940 +4325420
Adjustable mechanical stop (C8XL_J2)		Applied	Applied (standard)

5.2.3 Motion Range Setting of Joint #3

Remove the mechanical stop installed as standard and install the adjustable mechanical stop (J3). (Joint #3 standard motion range -61 to +202°)

Hexagon socket head cap bolt M6×15×2 bolts  
 Tightening torque 13.0 ± 0.6 N·m (133 ± 6 kgf·cm)

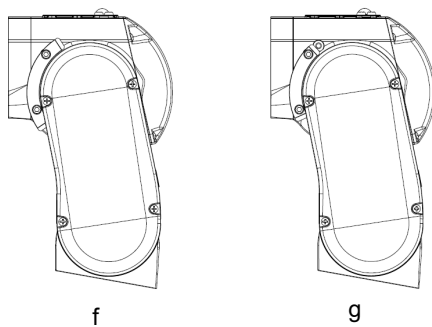

		f	g
Angle (°)		-51, +192	-61, +202
Pulse(pulse)	C8-A701*** (C8)	-1485483 +5592406	-1776754 +5883677
	C8-A901*** (C8L)	-1856859 +6990528	-2220949 +7354618
	C8-A1401*** (C8XL)	-3342336 +12582912	-3997696 +13238272
Adjustable mechanical stop (J3)		Applied	Applied (standard)

### 5.3 Restriction of Manipulator Operation by Joint Angle Combination

To prevent the arms of the Manipulator from interfering each other, the Manipulator operation is restricted in the specified motion range according to the joint angle combination of the Arm #1, #2, and #3.

The Manipulator operation is restricted and the Manipulator stops when the joint angles of the Arm are within the gray areas in the following figure.

The restriction to Manipulator operation is enabled:

- During CP motion command execution
- When you attempt to execute the motion command for moving the Manipulator to a target point (or pose) in the specified motion range.

The restriction to the Manipulator operation is disabled:

- The Arms of the Manipulator momentarily go through the specified motion range during the PTP motion command execution even though the joint angles of the Arms are in the colored area of the figures above.

C8-A701\*\*\*(C8)

Combination of Joints #2 and #3

-50 deg. <= J1 <= 50 deg.

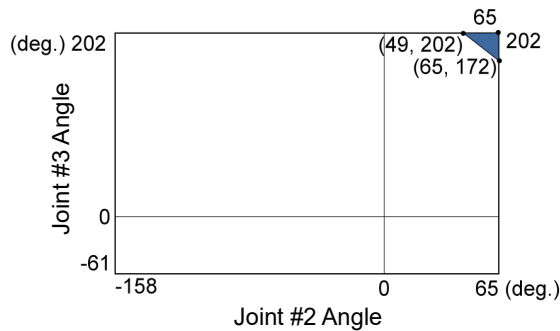

-120 deg. <= J1 < -50 deg. or 50 deg. < J1 <= 120 deg.

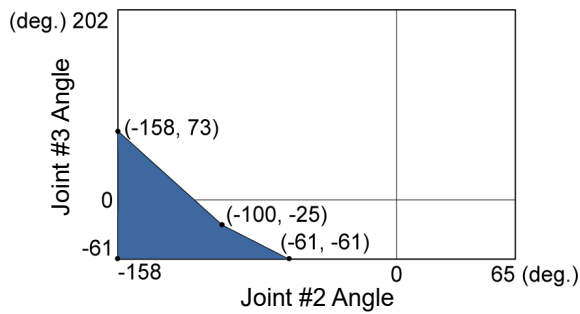

-240 deg. <= J1 < -120 deg. or 120 deg. < J1 <= 240 deg.

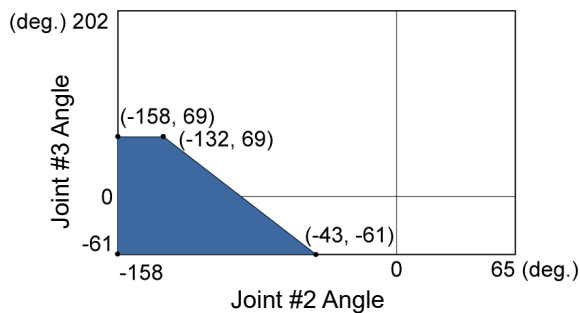

Combination of Joints #1 and #2

-240 deg. <= J1 <= -100 deg. or 100 deg. <= J1 <= 240 deg.

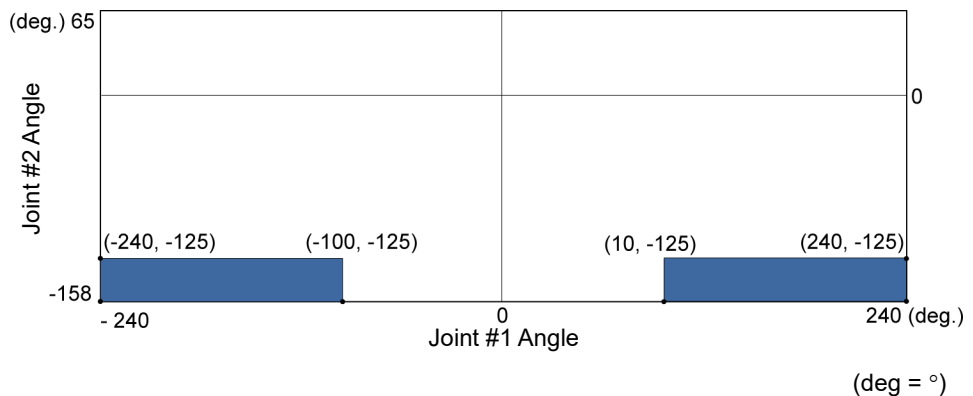

C8-A901\*\*\*(C8L)

Combination of Joints #2 and #3

-50 deg. <= J1 <= 50 deg.

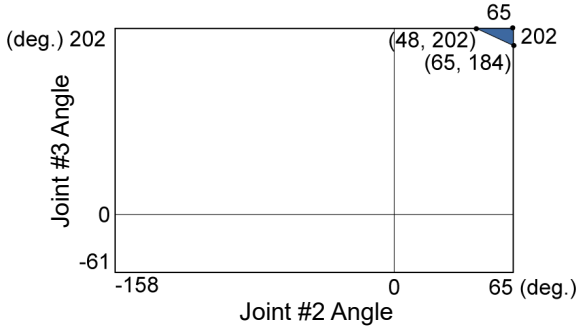

-120 deg. <= J1 < -50 deg. or 50 deg. < J1 <= 120 deg.

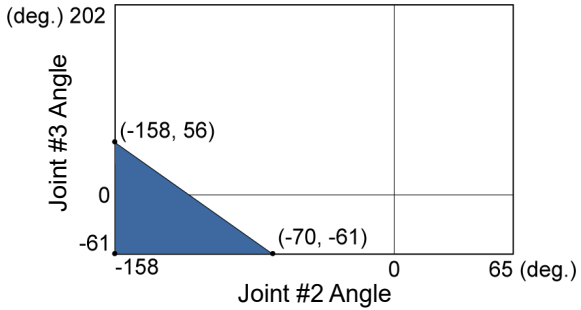

-240 deg. <= J1 < -120 deg. or 120 deg. < J1 <= 240 deg.

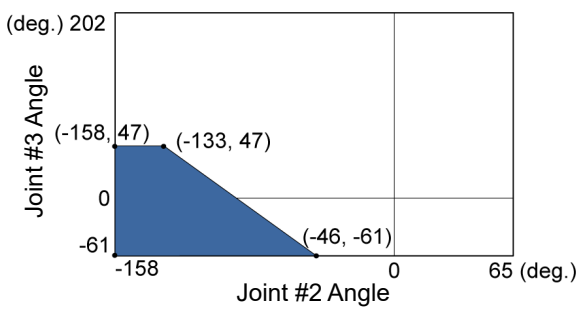

Combination of Joints #1 and #2

-240 deg. <= J1 <= -100 deg. or 100 deg. <= J1 <= 240 deg.

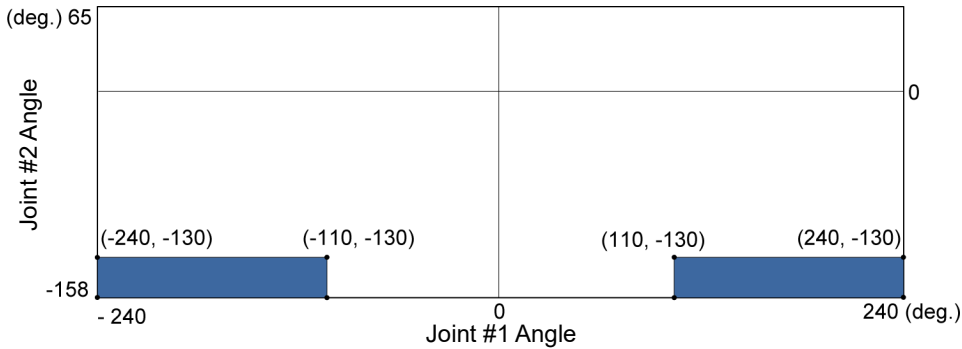

(deg = °)

C8-A1401\*\*\*(C8XL)

Combination of Joints #2 and #3

-110 deg. <= J1 <= 110 deg.

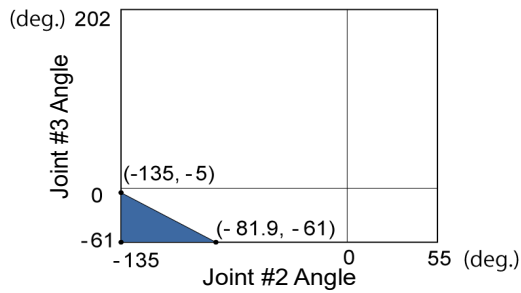

-140 deg. < J1 < -110 deg. or 110 deg. < J1 < 140 deg.

-240 deg. < J1 < -220 deg. or 220 deg. < J1 < 240 deg.

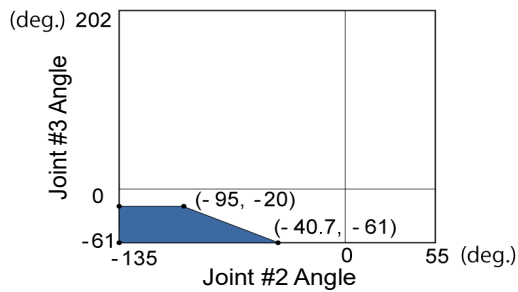

-220 deg. <= J1 <= -140 deg. or 140 deg. < J1 < 220 deg.

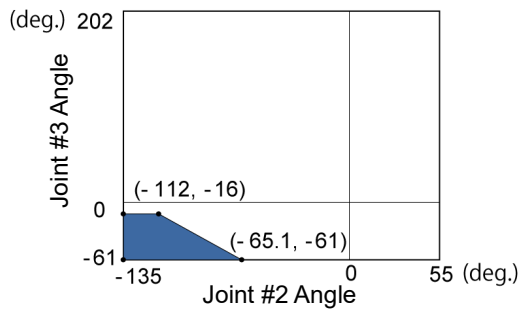

(deg = °)



## 5.4 Coordinate System

The origin point is where the Manipulator's installation face intersects with the rotation axis of Joint #1.

For details on the coordinate system, refer to the *EPSON RC+ Users Guide manual*.

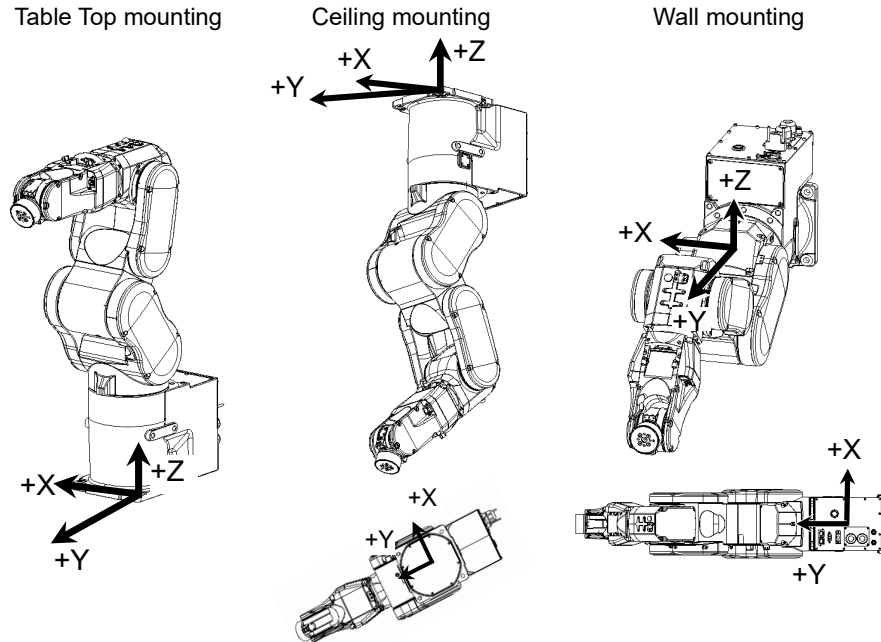

BASE setting is suitable for install the robot obliquely.

BASE setting can change a specific coordinate system of the robot and match the World coordinate system of the Jog & Teach and the coordinate system of the equipment.

For procedure of the BASE setting, refer to *SPEL+ Language Reference: BASE Command*.

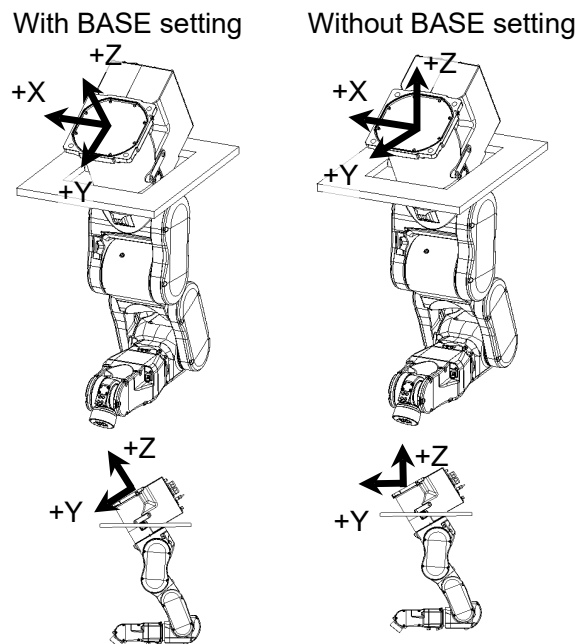

## 5.5 Changing the Robot

This section describes how to change the manipulator model on EPSON RC+.



CAUTION

- Changing the Manipulator should be done with great caution. It initializes the robot calibration parameters (Hofs, CalPIs), additional axis information, and PG parameter data.

Before changing the robot, make sure to save the calibration data by following the procedure below.

- Select the EPSON RC+ 7.0 menu-[Setup]-[System Configuration].
- Select [Controller]-[Robots]-[Robot\*\*]-[Calibration] from the tree list. Then, click <Save>.

(1) Select the EPSON RC+ 7.0 menu-[Setup]-[System Configuration].

(2) Select [Controller]- [Robots]-[Robot\*\*] from the tree list.

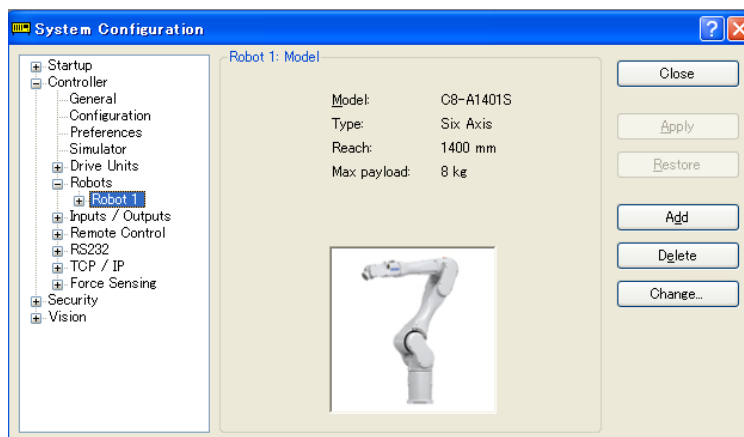

(3) Click the <Change...> button. The following dialog box will be displayed.

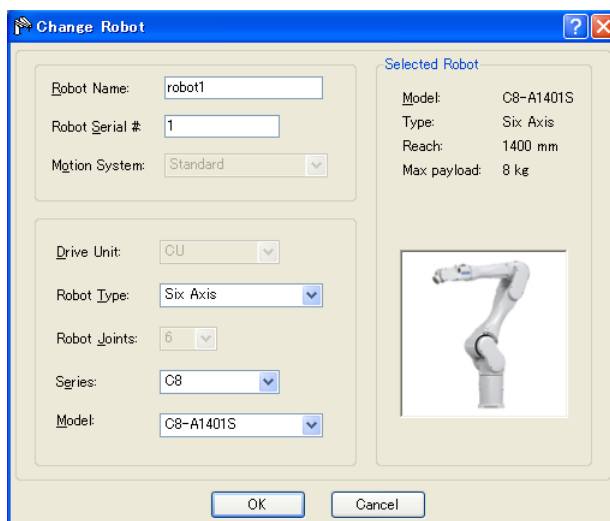

(4) Input the robot name and serial number printed on the name plate of the Manipulator. Any serial number can be entered. However, enter the number printed on the Manipulator.

(5) Select the robot type in the [Robot type] box.

- (6) Select the series name of the Manipulator in the [Series] box.
- (7) Select the robot model in the [Model] box. Available robots will be displayed according to the format of the currently installed motor driver. When [Dry run] is used, all the Manipulators of the series selected in Step 6 will be displayed.
- (8) Click the <OK> button. The Controller will be restarted.

## 5.6 Setting the Cartesian (Rectangular) Range in the XY Coordinate System of the Manipulator

The Cartesian (rectangular) range in the XY coordinate system of the Manipulator is specified by the limited Manipulator operation area and the XYLIM setting.

The limited Manipulator operation area is defined so that the end effector does not interfere with the rear side of the Manipulator. The XYLIM setting that you can determine the upper and lower limits of the X and Y coordinates.

The limited Manipulator operation area and the XYLIM setting apply only to the software. Therefore, these settings do not change the physical range. The maximum physical range is based on the position of the mechanical stops.

These settings are disabled during a joint jogging operation. Therefore, be careful not to allow the end effector to collide with the Manipulator or peripheral equipment.

The method for changing the XYLIM setting varies with the software used.

**EPSON  
RC+**

Set the XYLIM setting in [Tools]-[Robot manager]-[XYZ Limits] panel.  
You may also execute the XYLim command from the [Command Window].

## 6. Options



C8 series Manipulator has the following options.

- 6.1 Brake Release Unit
- 6.2 Camera Plate Unit
- 6.3 Tool Adapter (ISO flange)
- 6.4 Adjustable Mechanical Stops
- 6.5 User Wires and Pneumatic Tubes

### 6.1 Brake Release Unit

With the electromagnetic brake is ON (such as in Emergency Stop status), all arms don't move.

You can move the Arms by hand using the brake release unit while the Controller power is OFF or right after unpacking.

 <p>WARNING</p>	<ul style="list-style-type: none"> <li>■ When connecting / replacing the brake release unit or the external short connector, turn OFF the power to the Controller and the brake release unit. Inserting and removing the connector while the power is ON may result in electrical shock.</li> </ul>
 <p>CAUTION</p>	<ul style="list-style-type: none"> <li>■ Normally, release the brake of joints one by one. Take extra care if you need to release the brakes of two or more joints simultaneously. Releasing the brakes of two or more joints simultaneously may cause hands and fingers to be caught and/or equipment damage to or malfunction of the Manipulator as the arms of the Manipulator may move in unexpected directions.</li> <li>■ Be careful of the arm falling when releasing the brake. While the brake is being released, the Manipulator's arm falls by its own weight. The arm falling may cause hands and fingers to be caught and/or may cause equipment damage to or malfunction of the Manipulator.</li> </ul>

Width	180 mm
Depth	150 mm
Height	87 mm
Weight (Cables are not included.)	1.7 kg
Cable to the Manipulator	2 m
Power cable length	2 m
Power cable (US)	100 V specification
Power cable (EU)	200 V specification
M/C Short connector	For M/C power cable short-circuit

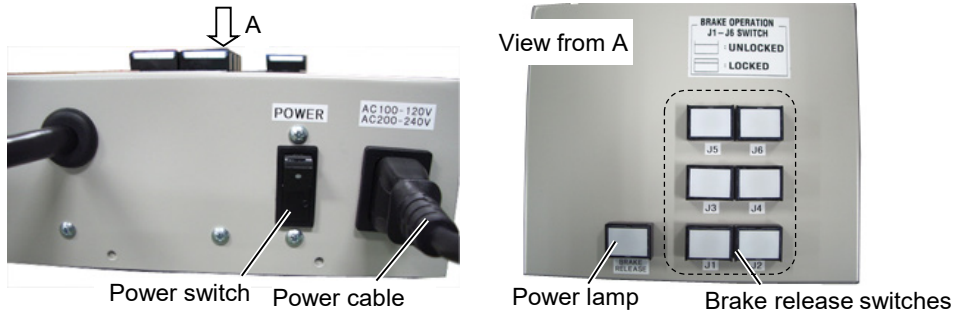

## Precautions for use



- If the Manipulator is operated without connecting the brake release unit and the external short connector, the brakes cannot be released and it may cause damage on them. After using the brake release unit, be sure to connect the external short connector to the Manipulator, or check connection of the connector for the brake release unit.
- Keep the external short connector. Otherwise you cannot release the brakes.
- If you turn ON the brake release unit while the brake release switch is being pressed, an unintended arm may move downward. Before turning ON the brake release unit, make sure that the brake release switch is not pressed.
- If you turn ON the brake release unit without the connector, it may lead to the short for the male pin used in the connector. Before turning ON the brake release unit, make sure that the connector is connected.

### Mount the brake release unit

- (1) Turn OFF the Controller.
- (2) If the M/C power cable is not connected to the Controller:  
Connect the M/C short connector,  
or connect the Controller.  
(Keep the Controller power OFF)  
  
The M/C short connector can be purchased singly.



- If the M/C power cable is already connected to the Controller:  
Go to the step (3).



- (3) Remove the external short connector.



External short connector

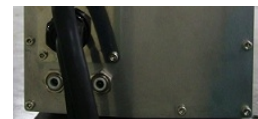

- (4) Connect the brake release unit to the connector of the connection cable.

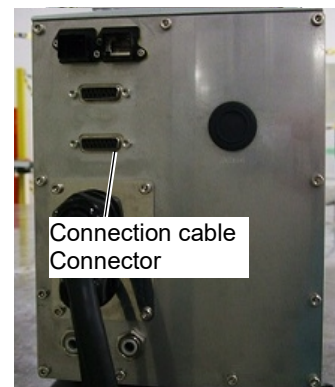

### Remove the brake release unit

- (1) Turn OFF the brake release unit.
- (2) Remove the power cable of the brake release unit.
- (3) Disconnect the brake release unit from the connector of the connection cable.
- (4) If the M/C short connector is connected to the M/C power cable, remove the short connector.
- (5) Connect the external short connector to the connector of the connection cable.

## How to use the brake release unit



- Be careful of the arm falling when releasing the brake.  
While the brake is being released, the Manipulator's arm falls by its own weight. The arm falling may cause hands and fingers to be caught and/or may cause equipment damage to or malfunction of the Manipulator.
- If the arm you released its brake moves awkwardly or faster than usual, stop the operation promptly and contact the supplier of your region. The brake release unit may be broken.  
If you keep operating the Manipulator, it may lead to the breakdown of the Manipulator or you may get your hand or fingers caught.



Power switch      Power cable



Power lamp      Brake release switches

- (1) Plug the power cable into the brake release unit.
- (2) Plug the power cable into the power supply plug.
- (3) Turn ON the brake release unit.  
When the brake release unit is enabled, the power lamp lights up.
- (4) Press the switch of the arm (J1 to J6) you want to move and then move the arm.  
Press the switch again. The brake will be released.  
The brake will be enabled by pressing the switch once again.



**NOTE** Move the arm the brake is released by two persons or more (one presses the switch and one moves the arm). The arm can be very heavy and needs the significant force to move.

## 6.2 Camera Plate Unit

To mount a camera to the C8 series Manipulator, you need to mount the camera plate unit first.

Appearance of arm end with camera

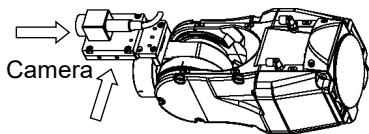

Camera plate unit

Parts included		Qty.
A	Camera adapter plate	1
B	Camera mid plate	1
C	Camera base plate	1
D	Hexagon socket head screws M4×12	6
E	Hexagon socket head screws M4×20	2
F	Plain washer for M4 (small washer)	2

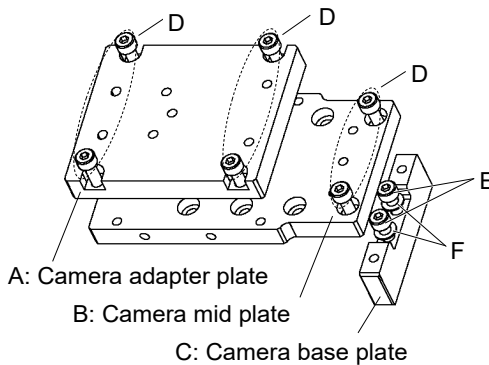

Installation

Mounting holes for the camera base plate on the C8 series Manipulator

Camera base plate mounting hole

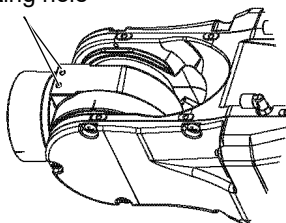

For the installation steps, refer to the following manual:

*EPSON RC+ Option Vision Guide 7.0 Hardware & Setup*

Dimension of the camera plate unit

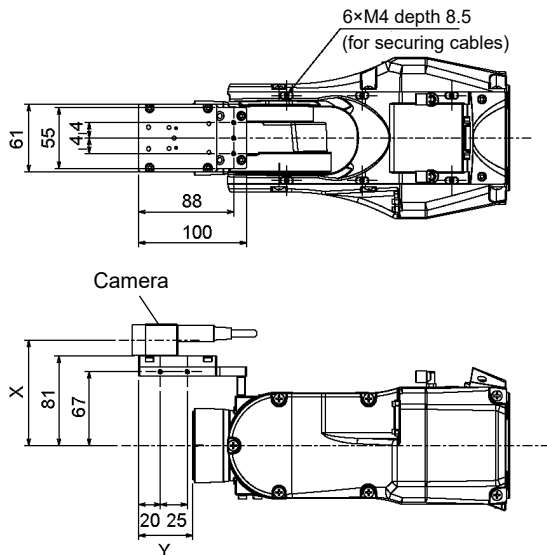



Dimensions X and Y will change depending on the position of camera mid plate and camera size. Refer to the table below for the values.

**Camera mid plate**

The camera mid plate uses the mounting holes A to D.

By using the different mounting holes, it can be mounted to the camera base plate in the different four positions.

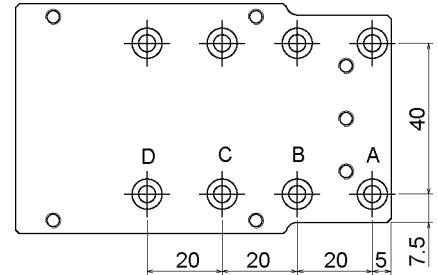

**Camera and C8 series Manipulator Joint #5 motion range (reference values)**

The Joint #5 motion range varies depending on the mounting position of camera mid plate and the camera you are using.

The table below shows the motion range (reference values) based on the available cameras for this option and the mounting positions of the camera mid plate. The values in the table may vary depending on how to secure the cables.

By changing the Y position, you can extend the distance from the end effector mounting surface to the camera. Also, you can attach the larger end effector. However, be careful about the Joint #5 motion range that will be limited in this case.

	A	B	C	D	X
USB camera, GigE camera	-135to +70°	-135 to +60°	-135 to +45°	-135 to +35°	95.5 mm

	A	B	C	D
Y	50 mm	30 mm	10 mm	-10 mm

**Direction of the Joint #5 motion**

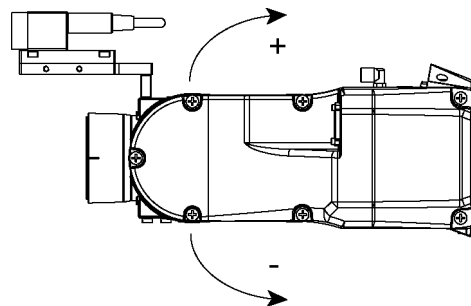

### 6.3 Tool Adapter (ISO Flange)

Using the tool adapter, you can mount the end effector whose dimensions are designed for the ISO flange to the C8 series Manipulators.

Parts included	Qty.
ISO flange	1
Flange	1
Pin	2
Hexagon socket head screw with low head M5×10	6
Hexagon socket head screw M5×15	4

#### Dimensions of ISO flange

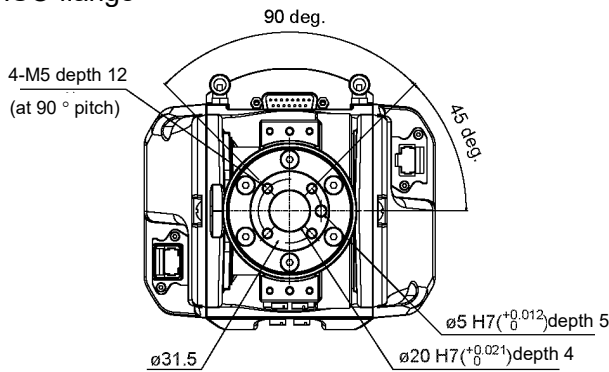

To mount the ISO flange

- (1) Press-fit the pin to the Arm #6 end flange.

Pin projection : 4 mm from the flange

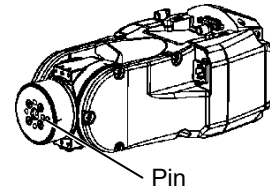

- (2) Align the pin and the pin hole on the flange, and then mount the flange.

Hexagon socket head screw: 4-M5×15

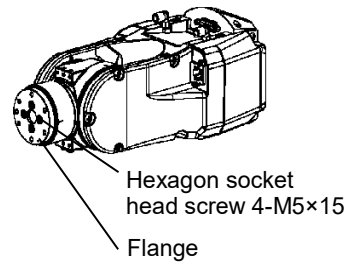

- (3) Press-fit the pin to the installed flange.

Pin protrusion: 4 mm from the flange

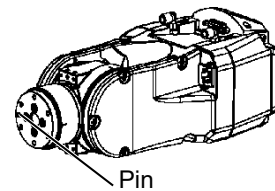

- (4) Align the pin and the pin hole on the ISO flange, and then mount the ISO flange.

Hexagon socket head screw with low head: 6-M5×10

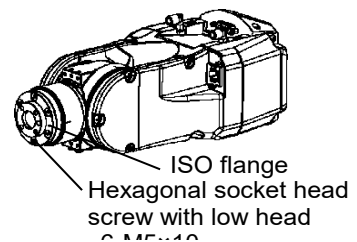

## 6.4 Adjustable Mechanical Stops

This option is used to mechanically limit the motion range of the Manipulator.

For installation and angle restriction measures, refer to *Setup & Operation 5.2 Motion Range Setting by Mechanical Stops*.

### Adjustable mechanical stop (J1)

Item	Qty.
Adjustable mechanical stop (J1)	1
Hexagon socket head screw M12×30	2

### Adjustable mechanical stop (C8/C8L J2)

Item	Qty.
Adjustable mechanical stop (C8/C8L J2)	1
Hexagon socket head screw M10×35	1

### Adjustable mechanical stop (C8XL J2)

Item	Qty.
Adjustable mechanical stop(C8XL J2)	1
Hexagon socket head screw M10×35	2

### Adjustable mechanical stop (J3)

Item	Qty.
Adjustable mechanical stop (J3)	1
Hexagon socket head screw M6×15	2

## 6.5 User Wires and Pneumatic Tubes

Use the following options when using the internal wiring and tubing for the end effector drive.

Fitting for customer use (ø6 straight)

Item	Qty.	Manufacturer	Standard
ø6 straight fitting	2	SMC	KQ2S06-M6N

\* Attached as standard. The parts can be purchased additionally in case of lost or shortage.

Fitting for customer use (ø6 elbow)

Item	Qty.	Manufacturer	Standard
ø6 elbow fitting	2	SMC	KQ2L06-M6N

\* Attached as standard. The parts can be purchased additionally in case of lost or shortage.

Standard user connector kit (D-sub)

Item	Qty.	Manufacturer	Standard
Connector	2	JAE	DA-15PF-N (Solder type)
Clamp hood	2	HRS	HDA-CTH(4-40)(10) (Connector setscrew: #4-40 UNC)

\* Attached to standard and cleanroom-model Manipulators as standard.  
The parts can be additionally purchased in case of lost or shortage.

Waterproof User Connector Kit (D-sub)

Item	Qty.	Manufacturer	Standard
Connector	2	HARTING	09 67 015 5615 (Solder type)
Clamp hood	2	HARTING	09 67 015 0538 (Connector setscrew: #4-40 UNC)

\* Attached to the protection model Manipulators as standard.  
The parts can be additionally purchased in case of lost or shortage.

Waterproof User Connector Kit (Ethernet)

Item	Qty.	Manufacturer	Standard
Connector	2	HARTING	09 45 145 1560

\* Not attached as standard. Please purchase the item if needed.  
Please note that the protection rating IP67 cannot be satisfied if other connectors are used.

# Maintenance

This volume contains maintenance procedures with safety precautions for C8 series Manipulators.



# 1. Safety Maintenance



Please read this chapter, this manual, and other relevant manuals carefully to understand safe maintenance procedures before performing any maintenance.

Only authorized personnel who have taken safety training should be allowed to perform the robot maintenance.

Safety training is the program for industrial robot operators to follow the laws and regulations of each nation.

The personnel who have taken safety training acquire knowledge of industrial robots (operations, teaching, etc.), inspections, and related rules/regulations.

The personnel who have completed the robot system-training and maintenance-training held by the manufacturer, dealer, or locally-incorporated company are allowed to perform maintenance.

 <b>WARNING</b>	<ul style="list-style-type: none"> <li>■ Do not remove any parts unless otherwise instructed by this manual. Follow the maintenance procedure strictly as described. Improper removal of parts or improper maintenance may cause not only malfunction of the robot system but serious safety problems.</li> <li>■ If you have not received training, keep away from the Manipulator while the power is ON. Do not enter the operating area while the power is ON. Entering the operating area with the power ON is extremely hazardous and may cause serious safety problems as the Manipulator may move even it seems to be stopped.</li> <li>■ When you check the operation of the Manipulator after replacing parts, be sure to check it while you are outside of the safeguarded area. Checking the operation of the Manipulator while you are inside of the safeguarded area may cause serious safety problems as the Manipulator may move unexpectedly.</li> <li>■ Before operating the robot system, make sure that both the Emergency Stop switches and safeguard switch function properly. Operating the robot system when the switches do not function properly is extremely hazardous and may result in serious bodily injury and/or serious damage to the robot system as the switches cannot fulfill their intended functions in an emergency.</li> </ul>
 <b>WARNING</b>	<ul style="list-style-type: none"> <li>■ To shut off power to the robot system, disconnect the power plug from the power source. Be sure to connect the AC power cable to a power receptacle. DO NOT connect it directly to a factory power source.</li> <li>■ Before performing any replacement procedure, turn OFF the Controller and related equipment, and then disconnect the power plug from the power source. Performing any replacement procedure with the power ON is extremely hazardous and may result in electric shock and/or malfunction of the robot system.</li> <li>■ When connecting / replacing the brake release unit or the external short connector, turn OFF the power to the Controller and the brake release unit. Connecting or disconnecting the connector while the power is ON may result in electrical shock.</li> </ul>



CAUTION

- Be sure to connect the cables properly. Do not allow unnecessary strain on the cables. (Do not put heavy objects on the cables. Do not bend or pull the cables forcibly.) It may result in damage to the cables, disconnection, and/or contact failure. These are extremely hazardous and may result in electric shock and/or improper function of the robot system.
- If the Manipulator is operated without connecting the brake release unit or the external short connector, the brakes cannot be released and it may cause damage on them. After using the brake release unit, be sure to connect the external short connector to the Manipulator, or check connection of the connector for the brake release unit.
- The Manipulator arms may become hot after the Manipulator operation due to heat generation of the motors. Be careful when performing maintenance.

## 2. General Maintenance

This chapter describes maintenance inspection procedures. Performing maintenance inspection properly is essential to prevent trouble and ensure safety.  
 Be sure to perform the maintenance inspections in accordance with the schedule.

### 2.1 Maintenance Inspection

#### 2.1.1 Schedule for Maintenance Inspection

Inspection points are divided into five stages: daily, monthly, quarterly, biannual, and annual. The inspection points are added every stage.  
 If the Manipulator is operated for 250 hours or longer per month, the inspection points must be added every 250 hours, 750 hours, 1500 hours, and 3000 hours operation.

	Inspection Point					
	Daily inspection	Monthly inspection	Quarterly inspection	Biannual inspection	Annual inspection	Overhaul (replacement)
1 month (250 h)	Inspect every day	√				
2 months (500 h)		√				
3 months (750 h)		√	√			
4 months (1000 h)		√				
5 months (1250 h)		√				
6 months (1500 h)		√	√	√		
7 months (1750 h)		√				
8 months (2000 h)		√				
9 months (2250 h)		√	√			
10 months (2500 h)		√				
11 months (2750 h)		√				
12 months (3000 h)		√	√	√	√	
13 months (3250 h)		√				
⋮	⋮	⋮	⋮	⋮	⋮	
20000 h						√

h = hour



### 2.1.2 Inspection Point

#### Inspection While the Power is OFF (Manipulator is not operating)

Inspection Point	Inspection Place	Daily	Monthly	Quarterly	Biannual	Annual
Check looseness or backlash of bolts/screws. Tighten them if necessary. (For the tightening torque, refer to <i>Maintenance: 2.4 Tightening Hexagon Socket Head Cap Bolts.</i> )	End effector mounting bolts	√	√	√	√	√
	Manipulator mounting bolts	√	√	√	√	√
	Each arm locking bolts	√	√	√	√	√
	Bolts/screws around shaft					√
	Bolts/screws securing motors, reduction gear units, etc.					√
Check looseness of connectors. If the connectors are loosen, push it securely or tighten.	External connectors on Manipulator (on the connector plates etc.)	√	√	√	√	√
	Manipulator cable unit		√	√	√	√
Visually check for external defects. Clean up if necessary.	External appearance of Manipulator	√	√	√	√	√
	External cables		√	√	√	√
Check for bends or improper location. Repair or place it properly if necessary.	Safeguard etc.	√	√	√	√	√
Check tension of timing belts. Tighten it if necessary.	Base Inside of Arms #1, 2, 3, 4				√	√
Grease conditions	Refer to <i>Maintenance: 2.3 Greasing.</i>					
Battery	Refer to <i>Maintenance: 11 Replacing the Battery.</i>					
Check either the external short connector or the brake release unit connector is connected.	The external short connector on the back side of the Manipulator, or the brake release unit connector.	√	√	√	√	√

Inspection While the Power is ON (Manipulator is operating)

Inspection Point	Inspection Place	Daily	Monthly	Quarterly	Biannual	Annual
Check motion range	Each joint					√
Move the cables back and forth lightly to check whether the cables are disconnected.	External cables				√	√
Push each arm in MOTOR ON status to check whether backlash exists.	Each arm					√
Check whether unusual sound or vibration occurs.	Whole	√	√	√	√	√
Measure the accuracy repeatedly by a dial gauge.	Whole					√
When brake release unit is installed: Connect the brake release unit and check the sound of the electromagnetic brake with the brake released. If there is no sound, replace the brake. When brake release unit is not installed: Execute Brake off command (brake off, joint #) from the command window of the EPSON RC+ while the motors are OFF, and then check the sound of the electromagnetic brake. If there is no sound, replace the brake.	Brake	√	√	√	√	√
Check if the fan is operating (C8-A1401*** (C8XL) Only)	Fan	√	√	√	√	√

## 2.2 Overhaul (Parts Replacement)



- Overhaul timing is based on an assumption that all joints are operated for equal distance. If a particular joint has a high duty or high load, it is recommended to overhaul all joints (as many as possible) before exceeding 20,000 operation hours with the joint as a basis.

The parts for the Manipulator joints may cause accuracy decline or malfunction due to deterioration of the Manipulator resulting from long term use. In order to use the Manipulator for a long term, it is recommended to overhaul the parts (parts replacement).

The time between overhauls is 20,000 operation hours of the Manipulator as a rough indication.

However, it may vary depending on usage condition and degree of the load (such as when operated with the maximum motion speed and maximum acceleration / deceleration in continuous operation) applied on the Manipulator.



For the EPSON RC+ 7.0 Ver. 7.2.x or later (firmware Ver.7.2.x.x or later), the recommended replacement time for the parts subject to maintenance (motors, reduction gear units, and timing belts) can be checked in the [Maintenance] dialog box of the EPSON RC+ 7.0.

For details, refer to the following manual.

*Robot Controller RC700 / RC700-A Maintenance 6. Alarm*

Note:

The recommended replacement time for the maintenance parts is when it reaches the L10 life (time until 10% failure probability). In the [Maintenance] dialog box, the L10 life is displayed as 100%.

The Manipulator operation hours can be checked in [Controller Status Viewer] dialog - [Motor On Hours].

- (1) Select EPSON RC+ menu-[Tools]-[Controller] to open the [Controller Tools] dialog.
- (2) Click the <View Controller Status> button to open the [Browse For Folder] dialog.
- (3) Select the folder where the information is stored.
- (4) Click <OK> to view the [Controller Status Viewer] dialog.
- (5) Select [Robot] from the tree menu on the left side.

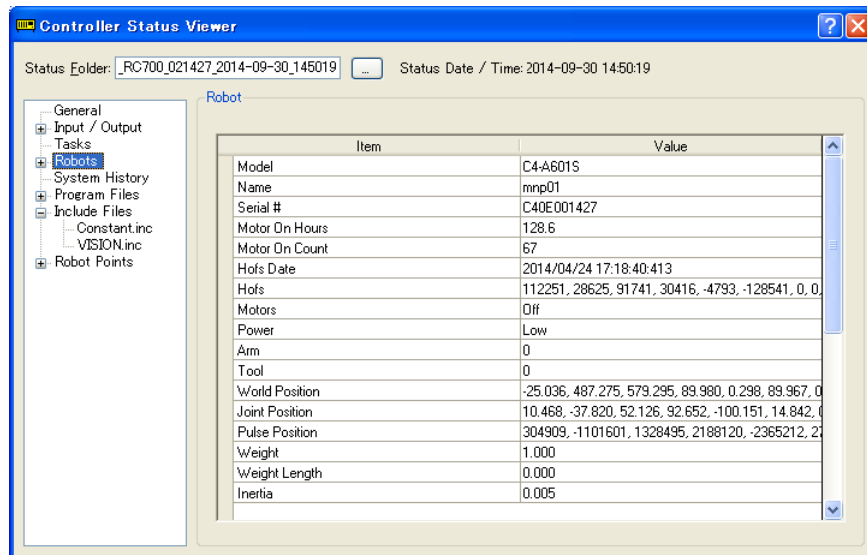

For the parts subject to overhaul, refer to *Maintenance 17. Maintenance Parts List*.

For details of replacement of each part, refer to the *Maintenance* section.

Please contact the supplier of your region for further information.

## 2.3 Greasing

The reduction gear units and the bevel gear need greasing regularly. Only use the grease specified in the following table.

 WARNING	<ul style="list-style-type: none"> <li>■ Before greasing, turn OFF the Controller and related equipment, and then disconnect the power plug from the power source. Performing any replacement procedure with the power ON is extremely hazardous and may result in electric shock and/or malfunction of the robot system.</li> </ul>
--	--

 CAUTION	<ul style="list-style-type: none"> <li>■ Keep enough grease in the Manipulator. Operating the Manipulator with insufficient grease will cause the noise or damage sliding parts and/or result in insufficient function of the Manipulator. Once the parts are damaged, a lot of time and money will be required for the repairs.</li> <li>■ If grease gets into your eyes, mouth, or on your skin, follow the instructions below.                     <ul style="list-style-type: none"> <li>If grease gets into your eyes: Flush them thoroughly with clean water, and then see a doctor immediately.</li> <li>If grease gets into your mouth: If swallowed, do not induce vomiting. See a doctor immediately. If grease just gets into your mouth, wash out your mouth with water thoroughly.</li> <li>If grease gets on your skin: Wash the area thoroughly with soap and water.</li> </ul> </li> </ul>
--	--

	Greasing part	Greasing Interval	Grease
Joints #1, 2, 3, 4, 5	Reduction gear units	Overhaul timing	SK-1A
Joint # 6			SK-2
Joint # 6	Bevel gear	Once a year (every 8000 hours)	SK-2

As a rough indication, perform greasing at the same timing as overhaul. However, it may vary depending on usage condition and degree of the load (such as when operated with the maximum motion speed and maximum acceleration / deceleration in continuous operation) applied on the Manipulator.

	Name	Quantity	Note
Maintenance parts	Grease up kit	1	1674592 (A set of grease gun, nipple, and extension jig)
	Grease plug	1	1656158
	O-ring for grease inlet	1	1657289
Tools	Hexagonal wrench (width across flats: 2 mm)	1	For M3 hexagon socket countersunk head bolts
	Hexagonal wrench (width across flats: 2.5 mm)	1	For M3 hexagon socket head cap bolts
	Cross-point screwdriver (#2)	1	For cross-recessed head screws
	Flat head screwdriver	1	For grease plug

NOTE  Before greasing, move the Manipulator so that the grease inlet is not directed down.  
Do not remove the grease plug while the grease inlet is directed down. Otherwise the oil content separated from the grease may leak out.

NOTE  Do not use any tool to install and remove the grease nipple and grease line extension jig.  
Always handle them directly by your hand.  
If the grease nipple or grease line extension jig is installed or removed with a tool such as wrench, they may be damaged.

### 2.3.1 Joint #1 Reduction Gear Unit (Table Top Mounting)

#### Greasing

1. Remove the Arm #1 side cover.  
For details, refer to *Maintenance: 3. Covers*.
2. Remove the grease plug from the Joint #1 grease inlet located inside the Arm #1.
3. Attach the grease nipple to the Joint #1 grease inlet.
4. Inject grease from the grease nipple using a grease gun  
Grease: SK-1A  
Grease amount: 11g
5. Remove the grease nipple from the Joint #1 grease inlet.
6. Attach the grease plug to the Joint #1 grease inlet.  
If the grease plug is damaged or deteriorated, replace it with a new one.
7. Install the Arm #1 side cover.  
For details, refer to *Maintenance: 3. Covers*.

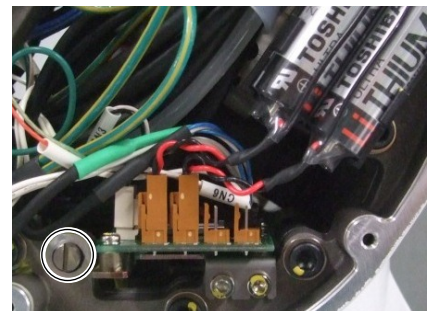
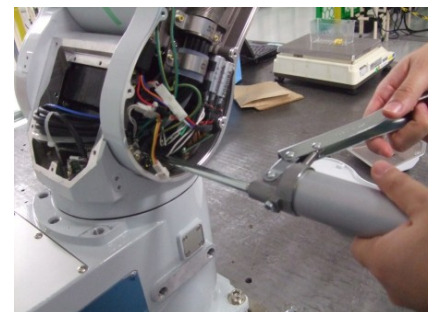
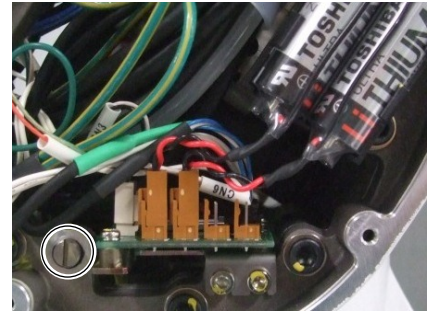

### 2.3.2 Joint #1 Reduction Gear Unit (Ceiling Mounting, Wall mounting)

#### Greasing

1. Remove the base grease inlet cover.

Hexagon socket flat head bolts: 4-M3×6



2. Remove the O-ring located in the base groove.
3. Remove the grease plug from the Joint #1 grease inlet located inside the base.
4. Attach the grease line extension jig and grease nipple to the Joint #1 grease inlet.



5. Inject grease from the grease nipple using a grease gun.

Grease: SK-1A

Grease amount: 11g



6. Remove the grease nipple and grease line extension jig from the Joint #1 grease inlet.
7. Attach the grease plug to the Joint #1 grease inlet.  
If the grease plug is damaged or deteriorated, replace it with a new one.



8. Apply a thin coat of grease (SK-1A) to the O-ring.  
Fit the O-ring into the base groove.  
Do not allow the O-ring to come out of the groove.  
If the O-ring is swollen, damaged, or deteriorated, replace it with a new one.



9. Install the base grease inlet cover.  
Hexagon socket flat head bolts: 4-M3×6  
Tightening torque:  $2.0 \pm 0.1$  N·m



### 2.3.3 Joint #2 Reduction Gear Unit

#### Greasing

1. Remove the grease plug from the Joint #2 grease inlet of the Arm #1.
2. Attach the grease nipple to the Joint #2 grease inlet.



3. Inject grease from the grease nipple using a grease gun  
Grease: SK-1A  
Grease amount: 6g (C8, C8L)  
12g (C8XL)

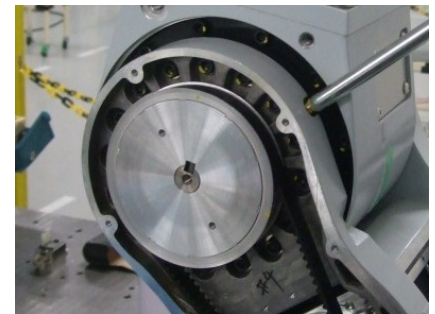

4. Remove the grease nipple from the Joint #2 grease inlet.
5. Attach the grease plug to the Joint #2 grease inlet.



If the grease plug is damaged or deteriorated, replace it with a new one.

### 2.3.4 Joint #3 Reduction Gear Unit

#### Greasing

1. Remove the grease plug from the Joint #3 grease inlet of the Arm #2.
2. Attach the grease nipple to the Joint #3 grease inlet.



3. Inject grease from the grease nipple using a grease gun

Grease: SK-1A

Grease amount: 3g



4. Remove the grease nipple from the Joint #3 grease inlet.
5. Attach the grease plug to the Joint #3 grease inlet.



If the grease plug is damaged or deteriorated, replace it with a new one.

### 2.3.5 Joint #4 Reduction Gear Unit

#### Greasing

1. Remove the grease plug from the Joint #4 grease inlet of the Arm #4.
2. Attach the grease nipple to the Joint #4 grease inlet.



NOTE The grease plug attaching hole located near the label with “4” printed is the Joint #4 grease inlet.

The grease inlet position differs depending on the model. Carefully identify the correct position.



3. Inject grease from the grease nipple using a grease gun

Grease: SK-1A

Grease amount: 2g

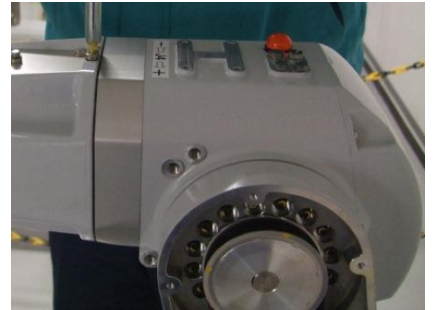

4. Remove the grease nipple from the Joint #4 grease inlet.
5. Attach the grease plug to the Joint #4 grease inlet.

If the grease plug is damaged or deteriorated, replace it with a new one.



### 2.3.6 Joint #5 Reduction Gear Unit

#### Greasing

1. Remove the grease plug from the Joint #5 grease inlet of the Arm #5.
2. Attach the grease nipple to the Joint #5 grease inlet.



The grease plug attaching hole located near the label with “5” printed is the Joint #5 grease inlet.

Be careful not to confuse it with the Joint #6 grease inlet.

3. Inject grease from the grease nipple using a grease gun.

Grease: SK-1A

Grease amount: 1g



Be careful not to mix with the grease used in the Joint #6 (SK-2).

4. Remove the grease nipple from the Joint #5 grease inlet.
5. Attach the grease plug to the Joint #5 grease inlet.

If the grease plug is damaged or deteriorated, replace it with a new one.



2.3.7 Joint #6 Reduction Gear Unit

Greasing

1. Remove the grease plug from the Joint #6 grease inlet of the Arm #5.
2. Attach the grease nipple to the Joint #6 grease inlet.



The grease plug attaching hole located near the label with “6” printed is the Joint #6 grease inlet.  
Be careful not to confuse it with the Joint #5 grease inlet.



3. Inject grease from the grease nipple using a grease gun.  
Grease: SK-2  
Grease amount: 0.5g



Be careful not to mix with the grease used in the Joint #5 (SK-1A).



4. Remove the grease nipple from the Joint #6 grease inlet.
5. Attach the grease plug to the Joint #6 grease inlet.

If the grease plug is damaged or deteriorated, replace it with a new one.



### 2.3.8 Joint #6 Bevel Gear

#### Greasing

1. Remove the Arm #5 grease inlet cover.  
Hexagon socket head cap bolts: 4-M3×6



2. Remove the O-ring located in the base groove.

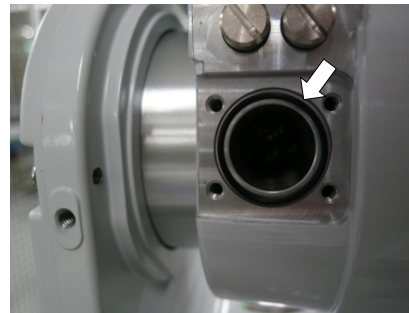

3. Apply grease to the mating surface of the bevel gear inside the Arm #5.

Grease: SK-2

Grease amount: 2g

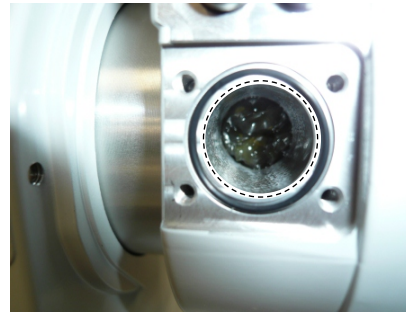

4. Apply a thin coat of grease (SK-2) to the O-ring.  
Fit the O-ring into the base groove.

Do not allow the O-ring to come out of the groove.

If the O-ring is swollen, damaged, or deteriorated, replace it with a new one.

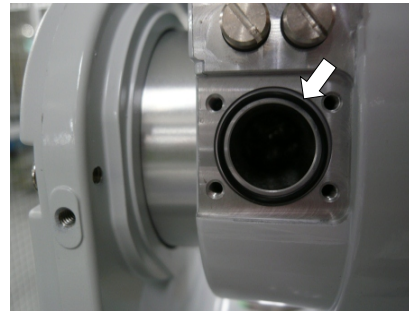

5. Install the Arm #5 grease inlet cover.  
Hexagon socket head cap bolts: 4-M3×6  
Tightening torque:  $2.0 \pm 0.1$  N·m



## 2.4 Tightening Hexagon Socket Head Bolts

Hexagon socket head cap bolts (hereinafter, “bolts”) are used in places where mechanical strength is required. These bolts are fastened with the tightening torque shown in the following tables.

When it is required to refasten the bolts in some procedures in this manual (except special cases as noted), use a torque wrench so that the bolts are fastened with appropriate tightening torque as shown below.

Bolt	Tightening Torque
M3	2.0 ± 0.1 N·m (21 ± 1 kgf·cm)
M4	4.0 ± 0.2 N·m (41 ± 2 kgf·cm)
M5	8.0 ± 0.4 N·m (82 ± 4 kgf·cm)
M6	13.0 ± 0.6 N·m (133 ± 6 kgf·cm)
M8	32.0 ± 1.6 N·m (326 ± 16 kgf·cm)
M10	58.0 ± 2.9 N·m (590 ± 30 kgf·cm)
M12	100.0 ± 5.0 N·m (1,020 ± 51 kgf·cm)

See below for the set screw.

Set Screw	Tightening Torque
M4	2.4 ± 0.1 N·m (26 ± 1 kgf·cm)
M5	3.9 ± 0.2 N·m (40 ± 2 kgf·cm)
M6	8.0 ± 0.4 N·m (82 ± 4 kgf·cm)

It is recommended to fasten the bolts aligned on a circumference in a crisscross pattern as shown in the figure below.

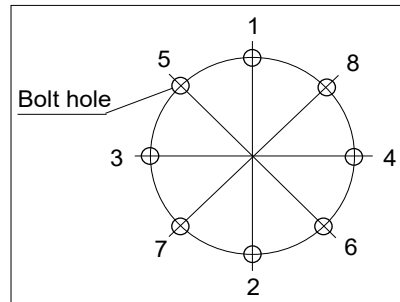

Do not fasten all bolts securely at one time. Divide the number of times to fasten the bolts into two or three and fasten the bolts securely with a hexagonal wrench. Then, use a torque wrench to fasten the bolts with tightening torques shown in the table above.



## 2.5 Layout of Maintenance Parts

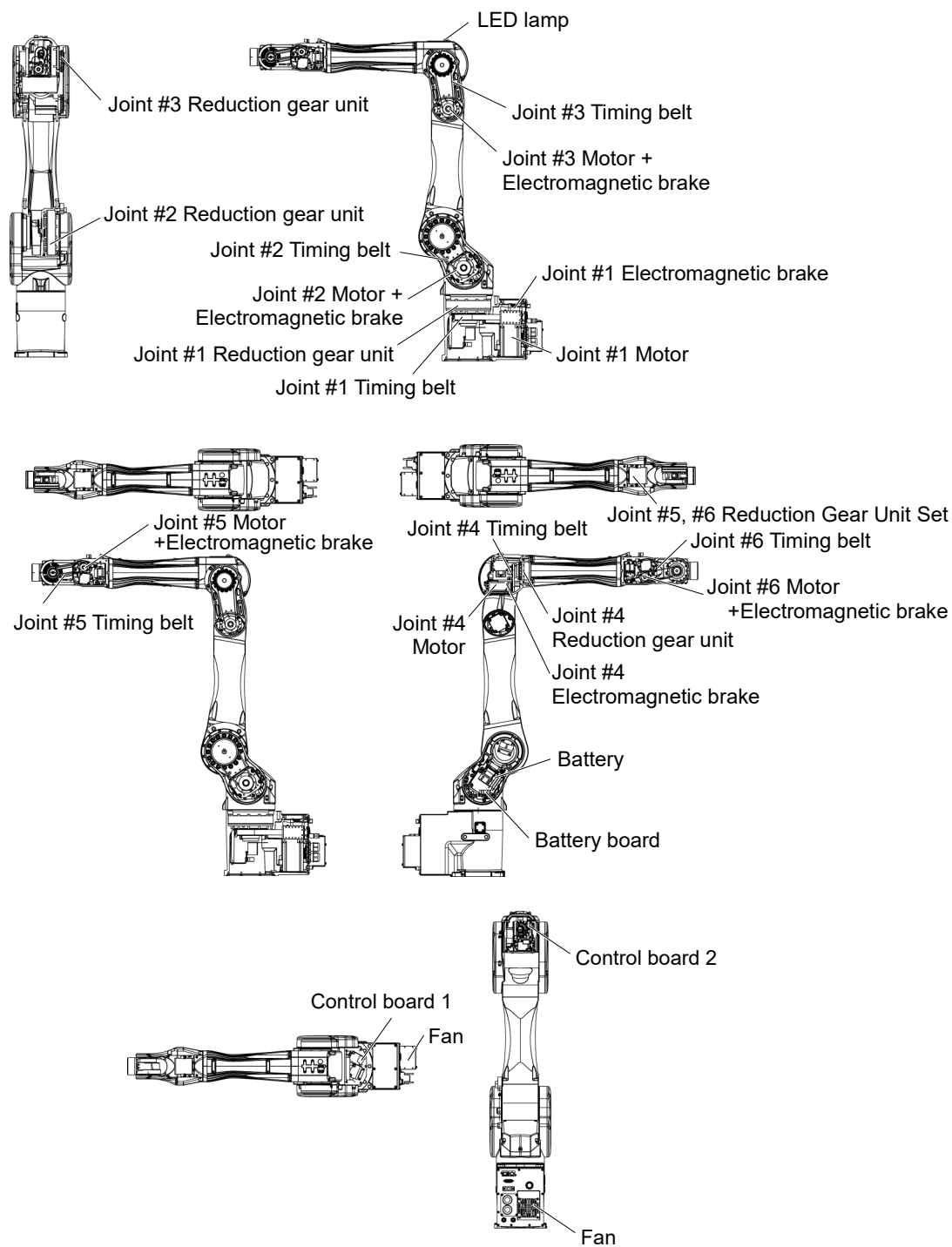

(Figure: C8-A1401\* (C8XL))



## 3. Covers

This chapter describes methods of removing and installing the covers and gaskets which are common to all maintenance procedures by Manipulator model.

S: Standard model

C: Clean-room & ESD model

P: Protection model



WARNING

- Do not connect or disconnect the motor connectors while the power to the robot system is turned ON. Connecting or disconnecting the motor connectors with the power ON is extremely hazardous and may result in serious bodily injury as the Manipulator may move abnormally, and also may result in electric shock and/or malfunction of the robot system.
- To shut off power to the robot system, disconnect the power plug from the power source. Be sure to connect the AC power cable to a power receptacle. DO NOT connect it directly to a factory power source.
- Before performing any replacement procedure, turn OFF the Controller and related equipment, and then disconnect the power plug from the power source. Performing any replacement procedure with the power ON is extremely hazardous and may result in electric shock and/or malfunction of the robot system.
- Be careful not to get any foreign substances in the Manipulator, connectors, and pins during maintenance. Turning ON the power to the robot system when any foreign substances exist in them is extremely hazardous and may result in electric shock and/or malfunction of the robot system.

Cable backward model

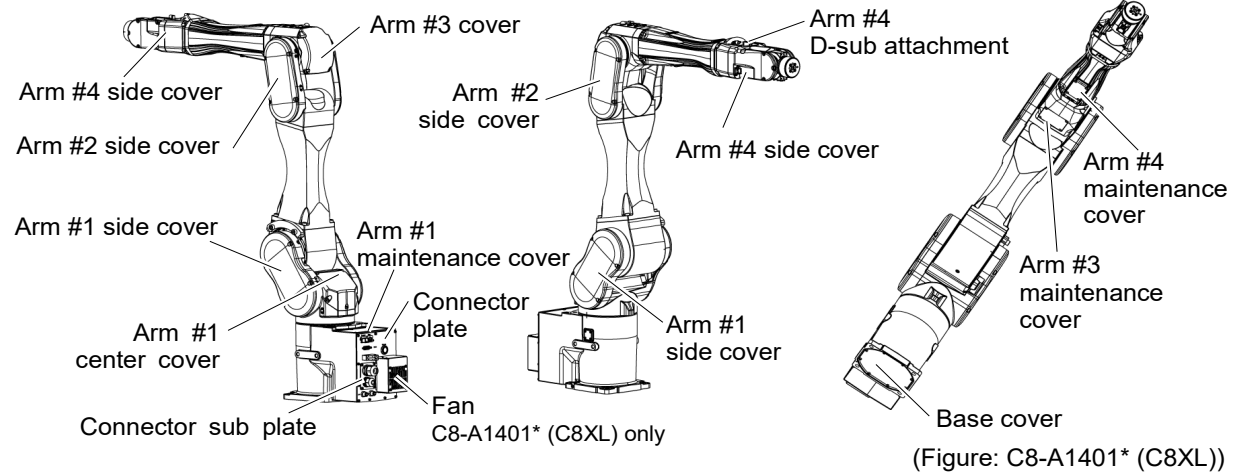

Cable downward model

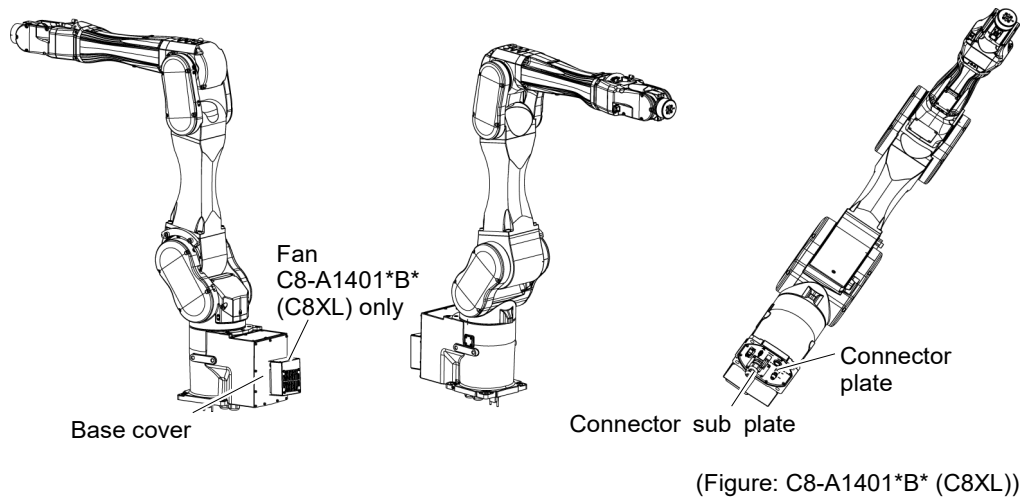

	Name		Quantity	Note		
Maintenance parts	Cover	Arm #1	Center cover	1	1675435	Metal cover Common to Standard/ Clean-room models
			Side cover	2	1674537	Standard model Plastic cover
		Arm #2	Side cover (left)	1	1655114	
			Side cover (right)	1	1674542	
		Arm #3	Cover	1	1674543	
		Arm #4	Side cover	2	1674547	
		Arm #1	Side cover	2	1674548	Cleanroom model Plating cover
		Arm #2	Side cover (left)	1	1655127	
			Side cover (right)	1	1674550	
		Arm #3	Cover	1	1674551	
	Arm #4	Side cover	2	1674553		
	Gasket	Arm #1	Center gasket	1	1665238	Protection model
			Side gasket	2	1665240	
		Arm #2	Side gasket	2	1665241	
			Arm #3	Cover gasket	1	
		Maintenance gasket		1	1665254	
		Arm #4	Side gasket	2	1665243	
			Maintenance gasket	1	1665257	
			D-sub attachment gasket	1	1665255	
		Base	Rear gasket	1	1665244	
			Bottom gasket	1	1665247	
			Maintenance gasket	1	1665248	
			Sub plate gasket	1	1665246	
Installation gasket	1		1668377			
		Gasket For heat sink	1	1694610	Cleanroom model Protection model	
	Seal washer		4	1665882	For M4	
	Air plug		2	1657011	For M6	
Tools	Hexagonal wrench	width across flats: 2.5 mm	1	For M3 hexagon socket head cap bolts		
		width across flats: 3 mm	1	For M4 hexagon socket head cap bolts		
	Cross-point screwdriver (#2)		1	For cross recessed screws		

### 3.1 Arm #1 Center Cover

 CAUTION	<ul style="list-style-type: none"> <li>When mounting the cover, be careful not to get the cables caught in it or bend them forcibly to push into the cover. Unnecessary strain on cables may result in damage to the cables, disconnection, and/or contact failure. These are extremely hazardous and may result in electric shock and/or improper function of the robot system. When routing the cables, check the cable locations at removing the cover. Be sure to place the cables back to their original locations.</li> </ul>
--	---

**Removal** Remove the screws and then remove the Arm #1 center cover.

S, C models:  
 Cross recessed truss head small screws: 5-M4×10

P model:  
 Hexagon socket head cap bolts with captive washer: 5-M4×12

Remove the Arm #1 center gasket together.



**Installation** S, C models:  
 Install the Arm #1 center cover to the Manipulator.  
 Cross recessed truss head small screws: 5-M4×10  
 Tightening torque:  $0.9 \pm 0.1$  N·m

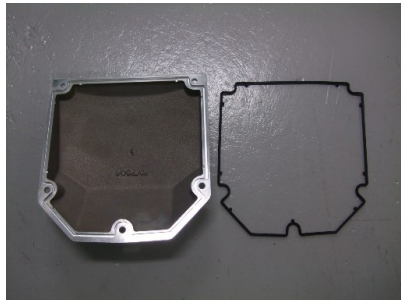

P model:  
 Install the gasket to the groove on the Arm #1 center cover.  
 Install the Arm #1 center cover to the Manipulator.  
 Hexagon socket head cap bolts with washer: 5-M4×12  
 Tightening torque:  $4.0 \pm 0.2$  N·m



NOTE  

Be careful not to get the gasket and cables caught between the cover and the Manipulator.  
 Replace the gasket if there are flaws or deteriorations.

## 3.2 Arm #1 Side Cover



CAUTION

- When mounting the cover, be careful not to get the cables caught in it or bend them forcibly to push into the cover. Unnecessary strain on cables may result in damage to the cables, disconnection, and/or contact failure. These are extremely hazardous and may result in electric shock and/or improper function of the robot system. When routing the cables, check the cable locations at removing the cover. Be sure to place the cables back to their original locations.

### Removal

Remove the screws and then remove the Arm #1 side cover.

S, C models:

Cross recessed truss head small screws:

4-M4×10 (one side)

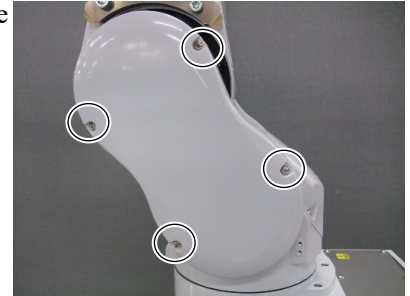

P model:

Hexagon socket head cap bolts with captive washer: 8-M4×12 (one side)

Remove the Arm #1 side gasket together.

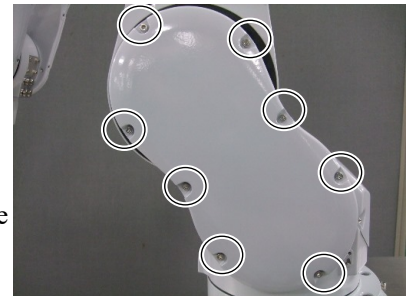

NOTE



The Arm #1 side covers and Arm #1 side gaskets are the same between right and left.

Installation

S, C models:

Install the Arm #1 side cover to the Manipulator.

Cross recessed truss head small screws:

4-M4×10 (one side)

Tightening torque:  $0.9 \pm 0.1 \text{ N}\cdot\text{m}$

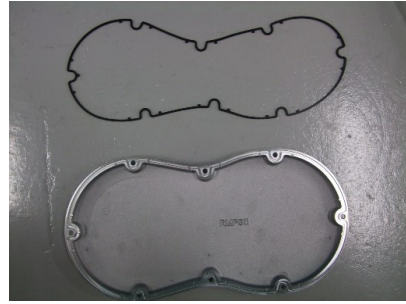

P model:

Install the gasket to the groove on the Arm #1 side cover.

Install the Arm #1 side cover to the Manipulator.

Hexagon socket head cap bolts with captive washer: 8-M4×12 (one side)

Tightening torque:  $4.0 \pm 0.2 \text{ N}\cdot\text{m}$



NOTE



Be careful not to get the gasket and cables caught between the cover and the Manipulator.

Replace the gasket if there are flaws or deteriorations.

When replacing the side cover for the right side of the Arm #1, attach the electrical shock warning label to the place indicated in the photo.



### 3.3 Arm #2 Side Cover



- When mounting the cover, be careful not to get the cables caught in it or bend them forcibly to push into the cover. Unnecessary strain on cables may result in damage to the cables, disconnection, and/or contact failure. These are extremely hazardous and may result in electric shock and/or improper function of the robot system. When routing the cables, check the cable locations at removing the cover. Be sure to place the cables back to their original locations.

#### Removal

Remove the screws and then remove the Arm #2 side cover.

S, C models:

Cross recessed truss head small screws:

4-M4×10 (one side)



P model:

Hexagon socket head cap bolts with captive washer: 8-M4×12 (one side)

Remove the Arm #2 side gasket together.

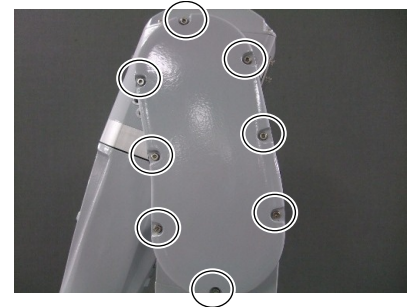

Note that the Arm #2 side covers and Arm #2 side gaskets are different between right and left.

#### Installation

S, C models:

Install the Arm #2 side cover to the Manipulator.

Cross recessed truss head small screws: 4-M4×10 (one side)

Tightening torque:  $0.9 \pm 0.1 \text{ N}\cdot\text{m}$

P model:

Install the gasket to the groove on the Arm #2 side cover. Install the Arm #2 side cover to the Manipulator.

Hexagon socket head cap bolts with captive washer: 8-M4×12 (one side)

Tightening torque:  $4.0 \pm 0.2 \text{ N}\cdot\text{m}$



Be careful not to get the gasket and cables caught between the cover and the Manipulator.

Replace the gasket if there are flaws or deteriorations.



### 3.4 Arm #3 Cover

 CAUTION	<ul style="list-style-type: none"> <li>When mounting the cover, be careful not to get the cables caught in it or bend them forcibly to push into the cover. Unnecessary strain on cables may result in damage to the cables, disconnection, and/or contact failure. These are extremely hazardous and may result in electric shock and/or improper function of the robot system. When routing the cables, check the cable locations at removing the cover. Be sure to place the cables back to their original locations.</li> </ul>
--	---

**Removal** Remove the screws and then remove the Arm #3 head cover.

S, C models:  
 Cross recessed truss head small screws: 4-M4×10

P model:  
 Hexagon socket head cap bolts with captive washer: 4-M4×12

Remove the Arm #3 gasket together.



**Installation** S, C models:  
 Install the Arm #3 cover to the Manipulator.  
 Cross recessed truss head small screws: 4-M4×10  
 Tightening torque:  $0.9 \pm 0.1 \text{ N}\cdot\text{m}$

P model:  
 Install the gasket to the groove on the Arm #3 head cover, and then install the Arm #3 cover to the Manipulator.  
 Cross recessed truss head small screws with captive washer: 4-M4×12  
 Tightening torque:  $4.0 \pm 0.2 \text{ N}\cdot\text{m}$

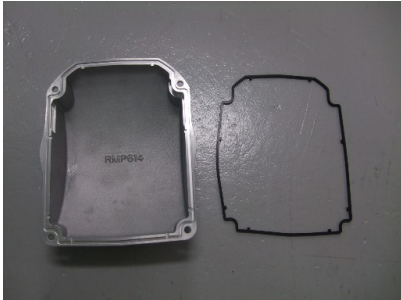

**NOTE**  Be careful not to get the gasket and cables caught between the cover and the Manipulator.  
 Replace the gasket if there are flaws or deteriorations.



### 3.5 Arm #3 Maintenance Cover



- When mounting the cover, be careful not to get the cables caught in it or bend them forcibly to push into the cover. Unnecessary strain on cables may result in damage to the cables, disconnection, and/or contact failure. These are extremely hazardous and may result in electric shock and/or improper function of the robot system. When routing the cables, check the cable locations at removing the cover. Be sure to place the cables back to their original locations.

#### Removal

1. Before removing the Arm #3 maintenance cover, move the arm to the position where you can remove the cover easily.
2. Remove the screws and then remove the Arm #3 maintenance cover.

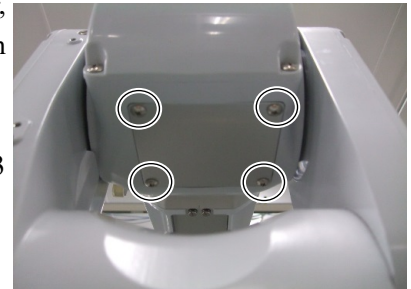

S, C models:

Cross recessed truss head small screws: 4-M4×8

P model:

Hexagon socket head cap bolts: 4-M4×10



Remove the Arm #3 maintenance gasket together. The gasket has the spacers. Be careful not to lose them.

Installation  
(S, C models)

Install the Arm #3 maintenance cover to the Manipulator.

Cross recessed truss head small screws: 4-M4×8

Tightening Torque:  $0.9 \pm 0.1$  N·m

Be careful not to get the cables caught between the cover and the Manipulator.

Installation  
(P model)

1. Install the spacers to the holes on the gasket.  
(4 places)



2. Apply the liquid gasket to the Arm #3 maintenance gasket.  
Install the Arm #3 maintenance gasket to the Arm #3 maintenance cover.  
(See the figure for gasket applying points)

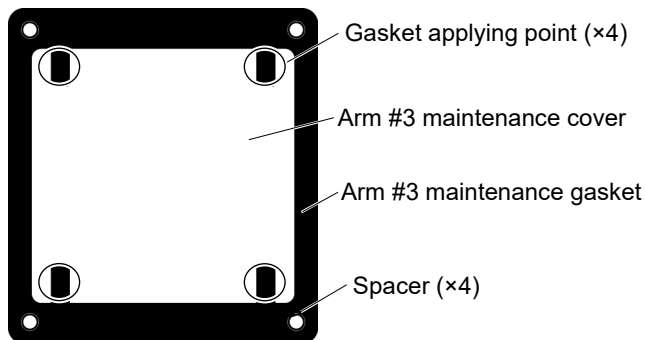

NOTE  

After applying the liquid gasket, leave the gasket until the liquid gasket becomes solid and the gasket is fixed.

3. Install the Arm #3 maintenance cover to the Manipulator.

Hexagon socket head cap bolts: 4-M4×10

Tightening torque:  $4.0 \pm 0.2$  N·m

NOTE  

Be careful not to get the gasket and cables caught between the cover and the Manipulator.

Replace the gasket if there are flaws or deteriorations.

## 3.6 Arm #4 Side Cover



CAUTION

- When mounting the cover, be careful not to get the cables caught in it or bend them forcibly to push into the cover. Unnecessary strain on cables may result in damage to the cables, disconnection, and/or contact failure. These are extremely hazardous and may result in electric shock and/or improper function of the robot system. When routing the cables, check the cable locations at removing the cover. Be sure to place the cables back to their original locations.

### Removal

1. Remove the screws and then remove the Arm #4 side cover.

S, C models:

Cross recessed truss head small screws:

7-M4×10 (one side)

P model:

Hexagon socket head cap bolts with captive washer: 7-M4×12 (one side)

Remove the Arm #4 side gasket together.

**NOTE** The Arm #4 side cover and Arm #4 side gasket are the same between right and left.

2. Remove the connectors.

RJ45 connector (left):

Remove the RJ45 connector from the connector on the cover.

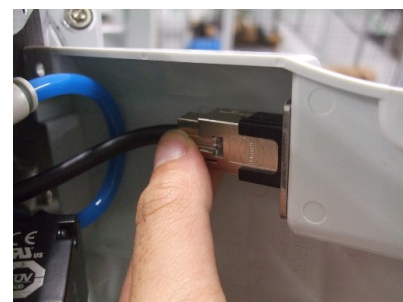
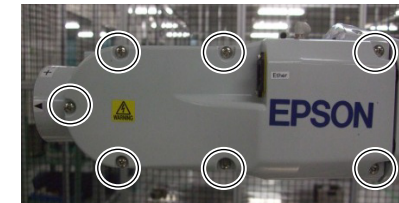

F-sensor connector (right):

Open the two plastic clips of the connector on the cover and pull out the metallic connector.

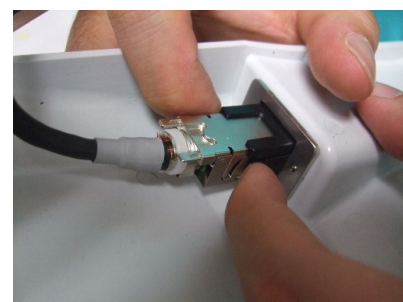

Installation

Insert the connectors.

RJ45 connector:

Insert the RJ45 connector to the connector on the cover.

F-sensor connector:

Insert the metallic connector to the connector on the cover.

S, C models:

Install the Arm #4 side cover to the Manipulator.

Cross recessed truss head small screws: 7-M4×10 (one side)

Tightening torque:  $0.9 \pm 0.1$  N·m

P model:

Install the Arm #4 side gasket to the groove on the Arm #4 side cover. Install the Arm #4 cover to the Manipulator.

Cross recessed truss head small screws:

7-M4×12 (one side)

Tightening torque:  $4.0 \pm 0.2$  N·m



Be careful not to get the gasket and cables caught between the cover and the Manipulator.

Replace the gasket if there are flaws or deteriorations.

When replacing the cover, attach the electrical shock warning label and other labels to the places indicated in the photos.



### 3.7 Arm #4 Maintenance Cover (C8XL only)



CAUTION

- When mounting the cover, be careful not to get the cables caught in it or bend them forcibly to push into the cover.  
Unnecessary strain on cables may result in damage to the cables, disconnection, and/or contact failure. These are extremely hazardous and may result in electric shock and/or improper function of the robot system.  
When routing the cables, check the cable locations at removing the cover.  
Be sure to place the cables back to their original locations.

#### Removal

1. Before removing the Arm #4 maintenance cover, move the arm to the position where you can remove the cover easily.
2. Remove the screws and then remove the Arm #4 maintenance cover.

S, C models:

Cross recessed truss head small screws:

4-M4×10

P model:

Hexagon socket head cap bolts: 4-M4×10



- NOTE  Remove the Arm #3 maintenance gasket together. The gasket has the spacers.  
Be careful not to lose them.

Installation (S, C models) Install the Arm #4 maintenance cover to the Manipulator.  
Cross recessed truss head small screws: 4-M4×10

Tightening torque:  $0.9 \pm 0.1$  N·m

Be careful not to get the cables caught between the cover and the Manipulator.

Installation (P model) 1. Install the spacers to the holes on the gasket.  
(4 places)



2. Apply the liquid gasket to the Arm #4 maintenance gasket.  
Install the Arm #4 maintenance gasket to the Arm #4 maintenance cover.  
(See the figure for gasket applying points)

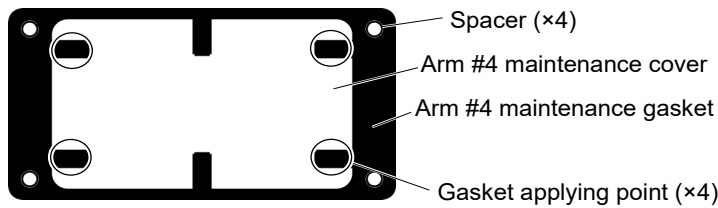

NOTE  After applying the liquid gasket, leave the gasket until the liquid gasket becomes solid and the gasket is fixed.

3. Install the Arm #4 maintenance cover to the Manipulator.

Hexagon socket head cap bolts: 4-M4×10

Tightening torque:  $4.0 \pm 0.2$  N·m

NOTE  Be careful not to get the gasket and cables caught between the cover and the Manipulator.

Replace the gasket if there are flaws or deteriorations.

## 3.8 Arm #4 D-sub Attachment



CAUTION

- Do not remove the D-sub attachment forcibly. Removing it forcibly may result in damage to the cables, disconnection, and/or contact failure. Damaged cables, disconnection, or contact failure is extremely hazardous and may result in electric shock and/or improper function of the robot system.
- When installing the D-sub attachment, be careful not to get the cables caught in it or bend them forcibly to push into the cover. Unnecessary strain on cables may result in damage to the cables, disconnection, and/or contact failure. These are extremely hazardous and may result in electric shock and/or improper function of the robot system. When routing the cables, check the cable locations at removing the D-sub attachment. Be sure to place the cables back to their original locations.

### Removal

Remove the screws and then remove the D-sub attachment.

Hexagon socket head cap bolts: 2-M4×10

P mode:

Remove the D-sub attachment gasket together.



### Installation

S, C models:

Install the D-sub attachment.

Hexagon socket head cap bolts: 2-M4×10

Tightening torque:  $4.0 \pm 0.2 \text{ N}\cdot\text{m}$

P model:

Install the D-sub attachment gasket to the Manipulator, and then install the D-sub attachment.

Hexagon socket head cap bolts: 2-M4×10

Tightening Torque:  $4.0 \pm 0.2 \text{ N}\cdot\text{m}$



- NOTE  Be careful not to get the gasket and cables caught between the cover and the Manipulator.  
Replace the gasket if there are flaws or deteriorations.



## 3.9 Base Cover

### 3.9.1 M/C Cable Backward

 CAUTION	<ul style="list-style-type: none"> <li>When mounting the cover, be careful not to get the cables caught in it or bend them forcibly to push into the cover. Unnecessary strain on cables may result in damage to the cables, disconnection, and/or contact failure. These are extremely hazardous and may result in electric shock and/or improper function of the robot system. When routing the cables, check the cable locations at removing the cover. Be sure to place the cables back to their original locations.</li> </ul>
--	---

The base cover of the M/C cable backward model is located on the bottom face of the base.

**Removal**

Remove the bolts and then remove the base cover.

Hexagon socket head cap bolts: 8-M4×10

P model:

Remove the base bottom gasket together.



**Installation**

S, C models:

Install the base cover to the Manipulator.

Hexagon socket head cap bolts: 8-M4×10

Tightening Torque:  $4.0 \pm 0.2$  N·m

P model:

Install the gasket to the groove on the base bottom face, and then install the base cover to the Manipulator.

Hexagon socket head cap bolts: 8-M4×10

Tightening Torque:  $4.0 \pm 0.2$  N·m

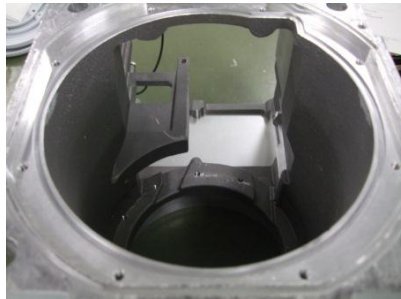

If the bolts other than the hexagon socket head cap bolts are used, the bolt heads may protrude from the end face of the base and the cover may not be fixed stably.



Be careful not to get the gasket and cables caught between the cover and the Manipulator. Replace the gasket if there are flaws or deteriorations.





## 3.9.2 M/C Cable Downward

 <p>CAUTION</p>	<ul style="list-style-type: none"> <li>When mounting the cover, be careful not to get the cables caught in it or bend them forcibly to push into the cover. Unnecessary strain on cables may result in damage to the cables, disconnection, and/or contact failure. These are extremely hazardous and may result in electric shock and/or improper function of the robot system. When routing the cables, check the cable locations at removing the cover. Be sure to place the cables back to their original locations.</li> </ul>
--	---

The base cover of the M/C cable downward model is located on the backside of the base.

C8-A701\*B\* (C8), C8-A901\*B\* (C8L)

**Removal** Remove the bolts and then remove the base cover.  
Hexagon socket head cap bolts: 11-M4×10

P model:

Remove the base rear gasket together.

**NOTE**  The gasket has the spacers. Be careful not to lose them.

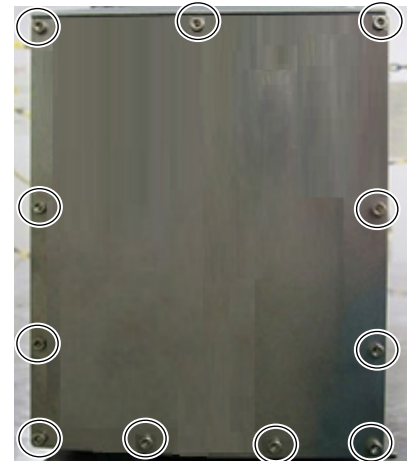

C8-A701\*B\* (C8), C8-A901\*B\* (C8L)

Installation Install the base cover to the Manipulator.

(S, C models)

Hexagon socket head cap bolts: 11-M4×10

Tightening Torque:  $4.0 \pm 0.2$  N·m

NOTE



Be careful not to get the cables caught between the cover and the Manipulator.

C8-A701\*B\* (C8), C8-A901\*B\* (C8L)

Installation  
(P model)

1. Install the spacers to the holes on the gasket.  
(11 places)



2. Apply the liquid gasket to the base rear gasket.  
Install the base rear gasket to the base cover.  
(See the figure for gasket applying points)

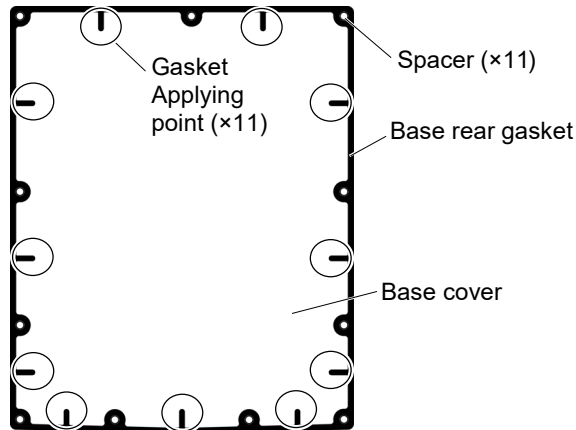

NOTE



After applying the liquid gasket, leave the gasket until the liquid gasket becomes solid and the gasket is fixed.

3. Install the base cover to the Manipulator.  
Hexagon socket head cap bolts: 11-M4×10  
Tightening torque:  $4.0 \pm 0.2$  N·m

NOTE



Be careful not to get the gasket and cables caught between the cover and the Manipulator.

Replace the gasket if there are flaws or deteriorations.

C8-A1401\*B\* (C8XL)

Removal

1. Remove the fan.  
For details, refer to *Maintenance 15. Replacing the Fan.*
2. Remove the bolts on the heat sink.  
Hexagon socket head cap bolts: 4-M4×15
3. Remove the heat sink.

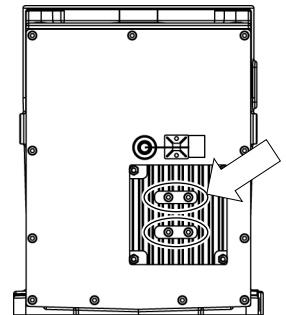

NOTE  For cleanroom and protection models, remove the gasket between the heat sink and the base cover.

4. Remove the bolts, and then remove the base cover and the base rear gasket.

Hexagon socket head cap bolts: 11-M4×10  
NOTE  The gasket has the spacers. Be careful not to lose them.

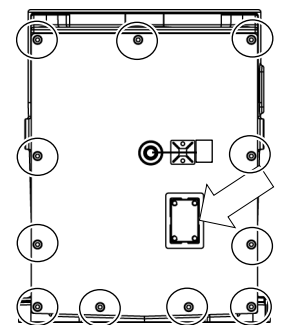

C8-A1401\*B\* (C8XL)

Installation

1. Install the spacers to the holes on the gasket. (11 places)
2. Apply the liquid gasket to the base rear gasket. Install the base rear gasket to the base cover. (See the figure for gasket applying points)

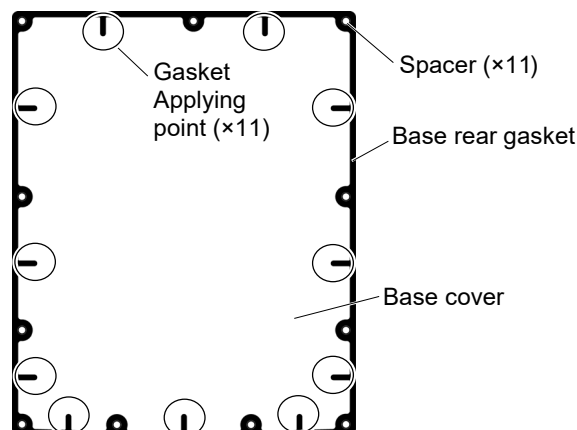

NOTE  After applying the liquid gasket, leave the gasket until the liquid gasket becomes solid and the gasket is fixed.

3. Install the base cover to the Manipulator.

Hexagon socket head cap bolts: 11-M4×10

Tightening torque:  $4.0 \pm 0.2$  N·m

**NOTE**  Be careful not to get the gasket and cables caught between the cover and the Manipulator.  
Replace the gasket if there are flaws or deteriorations.

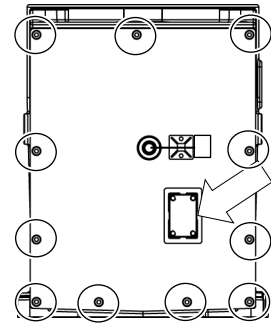

**NOTE**  For cleanroom and protection models, install the gasket between the heat sink and the base cover.

4. Install the heat sink.

Hexagon socket head cap bolts: 4-M4×15

Tightening torque:  $4.0 \pm 0.2$  N·m

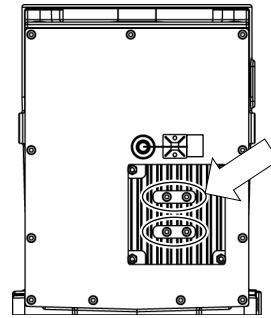

5. Install the fan.

For details, refer to *Maintenance 15. Replacing the Fan.*

## 3.10 Base Maintenance Cover



- When mounting the cover, be careful not to get the cables caught in it or bend them forcibly to push into the cover. Unnecessary strain on cables may result in damage to the cables, disconnection, and/or contact failure. These are extremely hazardous and may result in electric shock and/or improper function of the robot system. When routing the cables, check the cable locations at removing the cover. Be sure to place the cables back to their original locations.

### Removal

Remove the screws and then remove the base maintenance cover.

S, C models:

Cross recessed truss head small screws: 6-M4×10



P model:

Hexagon socket head cap bolts: 6-M4×10

Remove the base maintenance gasket together.

The gasket has the spacers. Be careful not to lose them.

### Installation (S, C models)

Install the base maintenance cover to the Manipulator.

Hexagon socket head cap bolts: 6-M4×10

Tightening Torque:  $0.9 \pm 0.1$  N·m

#### NOTE



Be careful not to get the cables caught between the cover and the Manipulator.

Installation  
(P model)

1. Install the spacers to the holes on the gasket.  
(6 places)



2. Apply the liquid gasket to the base maintenance gasket.  
Install the base maintenance gasket to the base cover.  
(See the figure for gasket applying points)

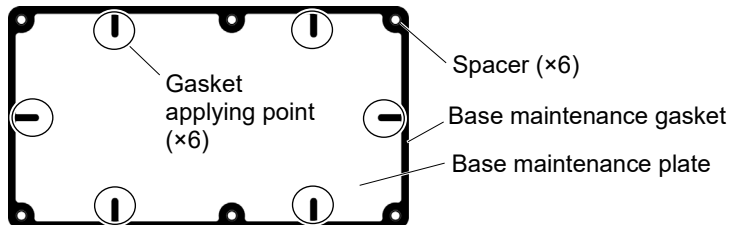

NOTE  After applying the liquid gasket, leave the gasket until the liquid gasket becomes solid and the gasket is fixed.

3. Install the base maintenance cover to the Manipulator.

Hexagon socket head cap bolts: 6-M4×10

Tightening torque:  $4.0 \pm 0.2$  N·m

NOTE  Be careful not to get the gasket and cables caught between the cover and the Manipulator.

Replace the gasket if there are flaws or deteriorations.

## 3.11 Connector Plate

### 3.11.1 M/C Cable Backward

 <b>CAUTION</b>	<ul style="list-style-type: none"> <li>■ Do not remove the connector plate forcibly. It may result in damage to the cables, disconnection, and/or contact failure. These are extremely hazardous and may result in electric shock and/or improper function of the robot system.</li> <li>■ When installing the connector plate, be careful not to get the cables caught in it or bend them forcibly to push into the cover. Unnecessary strain on cables may result in damage to the cables, disconnection, and/or contact failure. These are extremely hazardous and may result in electric shock and/or improper function of the robot system. When routing the cables, check the cable locations at removing the connector plate. Be sure to place the cables back to their original locations.</li> </ul>
---	---

C8-A701\*\* (C8), C8-A901\*\* (C8L)

**Removal** Remove the bolts and then remove the connector plate.

Hexagon socket head cap bolts: 11-M4×10

P model:

Remove the base rear gasket together.

**NOTE**  The gasket has the spacers. Be careful not to lose them.



C8-A701\*\* (C8), C8-A901\*\* (C8L)

Installation (S, C models) Install the connector plate to the Manipulator.  
 Hexagon socket head cap bolts: 11-M4×10  
 Tightening Torque:  $4.0 \pm 0.2$  N·m

Be careful not to get the cables caught between the cover and the Manipulator.

C8-A701\*\* (C8), C8-A901\*\* (C8L)

Installation (P model) 1. Install the spacers to the holes on the gasket.  
 (11 places)



2. Apply the liquid gasket to the base rear gasket.  
 Install the base rear gasket to the connector plate.  
 (See the figure for gasket applying points)

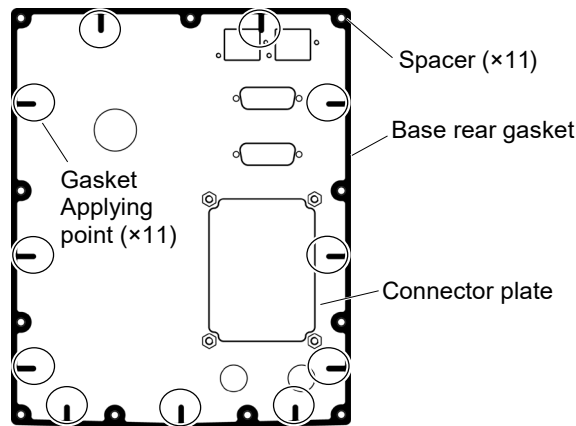

NOTE  After applying the liquid gasket, leave the gasket until the liquid gasket becomes solid and the gasket is fixed.

3. Install the connector plate to the Manipulator.  
 Hexagon socket head cap bolts: 11-M4×10  
 Tightening torque:  $4.0 \pm 0.2$  N·m

NOTE  Be careful not to get the gasket and cables caught between the cover and the Manipulator.  
 Replace the gasket if there are flaws or deteriorations.



C8-A1401\*\* (C8XL)

Removal

1. Remove the fan.  
For details, refer to *Maintenance 15. Replacing the Fan.*
2. Remove the bolts on the heat sink  
Hexagon socket head cap bolts: 4-M4×15
3. Remove the heat sink.

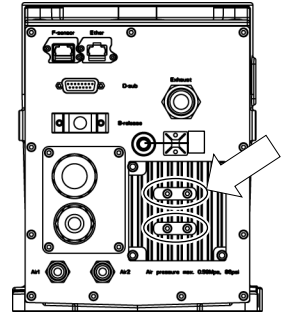

NOTE For cleanroom and protection models, remove the gasket between the heat sink and the connector plate.

4. Remove the bolts, and then remove the connector plate. and the base rear gasket.

Hexagon socket head cap bolts: 11-M4×10

NOTE The gasket has the spacers. Be careful not to lose them.

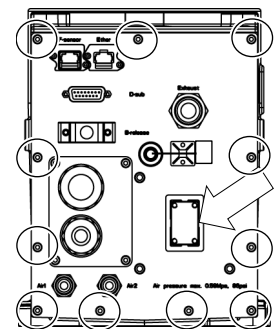

C8-A1401\*\* (C8XL)

Installation

1. Install the spacers to the holes on the gasket. (11 places)



2. Apply the liquid gasket to the base rear gasket. Install the base rear gasket to the base cover. (See the figure for gasket applying points)

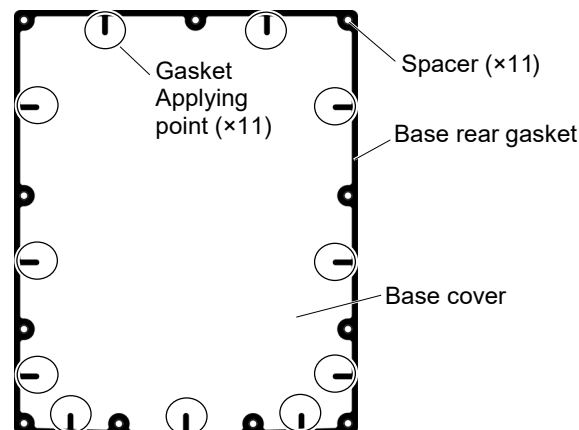

NOTE After applying the liquid gasket, leave the gasket until the liquid gasket becomes solid and the gasket is fixed.

3. Install the connector plate to the Manipulator.

Hexagon socket head cap bolts: 11-M4×10

Tightening torque:  $4.0 \pm 0.2$  N·m

NOTE  Be careful not to get the gasket and cables caught between the cover and the Manipulator.

Replace the gasket if there are flaws or deteriorations.

NOTE  For cleanroom and protection models, install the gasket between the heat sink and the connector plate.

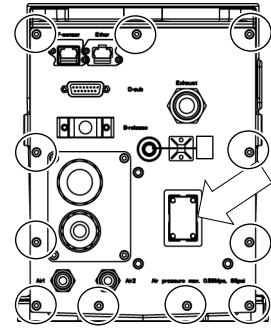

4. Install the heat sink.

Hexagon socket head cap bolts: 4-M4×15

Tightening torque:  $4.0 \pm 0.2$  N·m

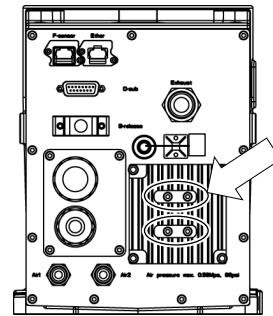

5. Install the fan.

For details, refer to *Maintenance 15. Replacing the Fan.*

## 3.11.2 M/C Cable Downward

 <b>CAUTION</b>	<ul style="list-style-type: none"> <li>■ Do not remove the connector plate forcibly. It may result in damage to the cables, disconnection, and/or contact failure. These are extremely hazardous and may result in electric shock and/or improper function of the robot system.</li> <li>■ When installing the connector plate, be careful not to get the cables caught in it or bend them forcibly to push into the cover. Unnecessary strain on cables may result in damage to the cables, disconnection, and/or contact failure. These are extremely hazardous and may result in electric shock and/or improper function of the robot system. When routing the cables, check the cable locations at removing the connector plate. Be sure to place the cables back to their original locations.</li> </ul>
---	---

## Removal

Remove the bolts and then remove the connector plate.

Hexagon socket head cap bolts: 8-M4×10

P model:

Remove the base bottom gasket together.



## Installation

S, C models:

Install the connector plate to the Manipulator.

Hexagon socket head cap bolts: 8-M4×10

Tightening Torque:  $4.0 \pm 0.2$  N·m

P model:

Install the base bottom gasket to groove on the base bottom face. Install the connector plate to the Manipulator.

Hexagon socket head cap bolts: 8-M4×10

Tightening Torque:  $4.0 \pm 0.2$  N·m

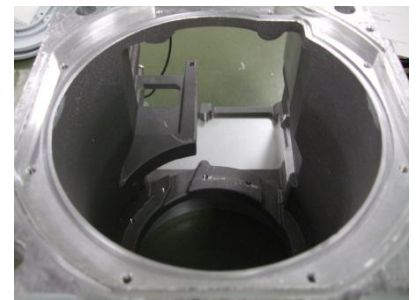

## NOTE



Be careful not to get the gasket and cables caught between the cover and the Manipulator.

Replace the gasket if there are flaws or deteriorations.

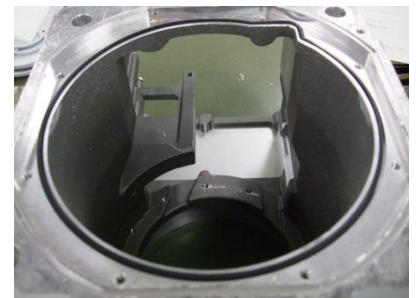

### 3.12 Connector Sub Plate



- Do not remove the connector sub plate forcibly. It may result in damage to the cables, disconnection, and/or contact failure. These are extremely hazardous and may result in electric shock and/or improper function of the robot system.
- When removing the connector sub plate, make sure to remove all connectors of the connector plate and the M/C cable. Removing only the connector sub plate may result in damage to the cables, disconnection, and/or contact failure. These are extremely hazardous and may result in electric shock and/or improper function of the robot system.
- When installing the connector sub plate, be careful not to get the cables caught in it or bend them forcibly to push into the cover. Unnecessary strain on cables may result in damage to the cables, disconnection, and/or contact failure. These are extremely hazardous and may result in electric shock and/or improper function of the robot system. When routing the cables, check the cable locations at removing the connector sub plate. Be sure to place the cables back to their original locations.

#### Removal

Remove the bolts and then remove the connector sub plate.

S, C models:

Hexagon socket head cap bolts: 4-M4×10

P model:

Hexagon socket head cap bolts:

4-M4×10 (with a seal washer)



Remove the base sub plate gasket together. The gasket has the spacers. Be careful not to lose the seal washers and spacers.

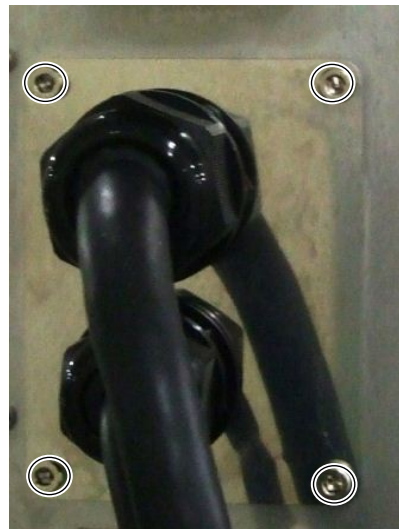

Installation (S, C models) Install the connector sub plate to the Manipulator.  
Hexagon socket head cap bolts: 4-M4×10

Tightening Torque:  $4.0 \pm 0.2$  N·m



Be careful not to get the cables caught between the cover and the Manipulator.

Installation (P model) 1. Install the spacers to the holes on the gasket. (4 places)



2. Apply the liquid gasket to the base sub plate gasket. Install the base sub plate gasket to the connector sub plate. (See the figure for gasket applying points)

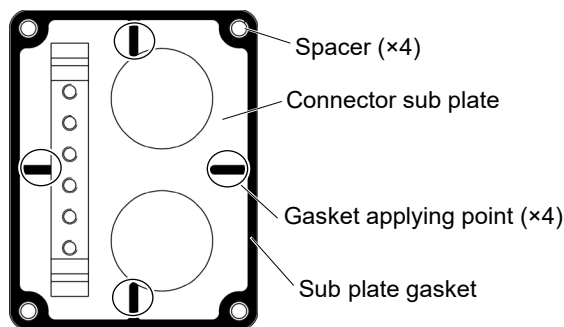

After applying the liquid gasket, leave the gasket until the liquid gasket becomes solid and the gasket is fixed.

3. Install the connector sub plate to the Manipulator.

Hexagon socket head cap bolts: 4-M4×10 (with a seal washer)

Tightening torque:  $4.0 \pm 0.2$  N·m



Be careful not to get the gasket and cables caught between the cover and the Manipulator.

Replace the seal washers and gasket if there are flaws or deteriorations.

## 4. Cable Unit

### 4.1 Replacing the Cable Unit



WARNING

- Before performing any replacement procedure, turn OFF the Controller and related equipment, and then disconnect the power plug from the power source. Performing any replacement procedure with the power ON is extremely hazardous and may result in electric shock and/or malfunction of the robot system.
- Do not connect or disconnect the motor connectors while the power to the robot system is turned ON. Connecting or disconnecting the motor connectors with the power ON is extremely hazardous and may result in serious bodily injury as the Manipulator may move abnormally, and also may result in electric shock and/or malfunction of the robot system.
- Be sure to connect the AC power cable to a power receptacle. DO NOT connect it directly to a factory power source. To shut off power to the robot system, disconnect the power plug from the power source. Performing any work while connecting the AC power cable to a factory power source is extremely hazardous and may result in electric shock and/or malfunction of the robot system.
- Be careful not to get any foreign substances in the Manipulator, connectors, and pins during maintenance. Turning ON the power to the robot system when any foreign substances exist in them is extremely hazardous and may result in electric shock and/or malfunction of the robot system.
- Be sure to connect the cables properly. Do not allow unnecessary strain on the cables. (Do not put heavy objects on the cables. Do not bend or pull the cables forcibly.) Unnecessary strain on the cables may result in damage to the cables, disconnection, and/or contact failure. These are extremely hazardous and may result in electric shock and/or improper function of the robot system.
- When mounting the cover, be careful not to allow the cables to interfere with the cover mounting and do not bend these cables forcibly to push them into the cover. Unnecessary strain on cables may result in damage to the cables, disconnection, and/or contact failure. Damaged cables, disconnection, or contact failure is extremely hazardous and may result in electric shock and/or improper function of the robot system.  
When routing the cables, observe the cable locations after removing the cover. Be sure to place the cables back to their original locations.

 <b>CAUTION</b>	<ul style="list-style-type: none"> <li>■ When disconnecting the connectors during the replacement of the cable unit, be sure to reconnect the connectors to their proper positions. Improper connection of the connectors may result in improper function of the robot system. For details on the connections, refer to the <i>Maintenance 4.2 Connector Pin Assignments</i>.</li> <li>■ Carefully use alcohol and adhesive following respective instructions and also instructions below. Otherwise, it may cause a fire and/or safety problems. <ul style="list-style-type: none"> <li>- Never put alcohol or adhesive close to fire.</li> <li>- Use alcohol or adhesive while ventilating the room.</li> <li>- Wear protective gear including a mask, protective goggles, and oil-resistant gloves.</li> <li>- If alcohol or adhesive gets on your skin, wash the area thoroughly with soap and water.</li> <li>- If alcohol or adhesive gets into your eyes or mouth, flush your eyes or wash out your mouth with clean water thoroughly, and then see a doctor immediately.</li> </ul> </li> <li>■ Wear protective gear including a mask, protective goggles, and oil-resistant gloves during grease up. If grease gets into your eyes, mouth, or on your skin, follow the instructions below. <ul style="list-style-type: none"> <li>If grease gets into your eyes : Flush them thoroughly with clean water, and then see a doctor immediately.</li> <li>If grease gets into your mouth : If swallowed, do not induce vomiting. See a doctor immediately. If grease just gets into your mouth, wash out your mouth with water thoroughly.</li> <li>If grease gets on your skin : Wash the area thoroughly with soap and water.</li> </ul> </li> </ul>
---	---

4.1.1 Replacing the Cable Unit (M/C Cable Backward)

	Name		Qty.	Note	
Maintenance Parts	Cable unit	C8-A701** (C8)	1	For standard, cleanroom models	2172929
			1	For protection model	2172932
		C8-A901** (C8L)	1	For standard, cleanroom models	2172930
			1	For protection model	2172933
		C8-A1401** (C8XL)	1	For standard, cleanroom models	2172931
			1	For protection model	2172934
	Belt tensile jig*		1	1674582	
	J1 brake positioning jig*		1	1675081	
	Wire tie	AB100	1	1675753	
		AB150	1	1675754	
Tools	Hexagonal wrench	width across flats: 2.5 mm	1	For M3 hexagon socket head cap bolts	
		width across flats: 3 mm	1	For M4 hexagon socket head cap bolts	
		width across flats: 4 mm	1	For M5 hexagon socket head cap bolts	
		width across flats: 5 mm	1	For M6 hexagon socket head cap bolts	
	Box wrench	width across flats: 5 mm	1	For D-Sub connector	
	Long nose pliers		1	For removing an air tube	
	Nippers		1	For cutting a wire tie	
	Cross-point screwdriver (#2)		1	For cross recessed head screws	
	Torque rench		1	For tightening torque control	
	Belt tension meter		1	Refer: Unitta U-505	

\* The belt tensile jig is an assembly jig. Use this jig when adjusting belt tension.

The brake is mounted on each joint to prevent the arm from lowering due to its own weight while the Controller power is OFF or the motor is OFF status. The brake does not work during replacement. Be careful when performing maintenance work.

When removing the Joint #2 motor, tilt the Arm #2 and press it against the Arm #1.

Reference: *Maintenance: 6.1 Joint #2 - Replacing the Motor*, Removal step (2)

When removing the Joint #3 motor, tilt the Arm #2 and press it against the Arm #2.

Reference: *Maintenance: 7.1 Joint #3 - Replacing the Motor*, Removal step (2)

When pressing the arm, put a piece of cloth or a similar material between the arms to avoid contacting each other. This protects the arm surfaces from scratching and paint peeling off.



**Removal: Cable unit (M/C cable backward)**

1. Move the Manipulator to the origin posture (0 pulse position).
2. Turn OFF the Controller.
3. Remove the following covers and plate.

For details, refer to *Maintenance: 3. Covers*.

Arm #4 side covers (both sides)	Arm #4 maintenance cover (C8XL only)
Arm #3 cover	Arm #3 maintenance cover
Arm #2 side covers (both sides)	Arm #1 side covers (both sides)
Arm #1 center cover	Base maintenance cover
Connector plate (M/C cable backward)	

4. Remove the two air tubes inside the base.
5. Remove the two D-sub connectors.
6. Disconnect the cables from the base and disconnect the following connectors.

Connectors: X11, X12, X14, BR010, BR011, X010, X020,  
X040, LED, GS01, BT1  
(Hold the clip to remove.)



7. Disconnect the following connectors.

RJ45 connector:

Hold the clip to remove.



F-sensor connector:

Open the clips on the both ends of the connector and pull it out.

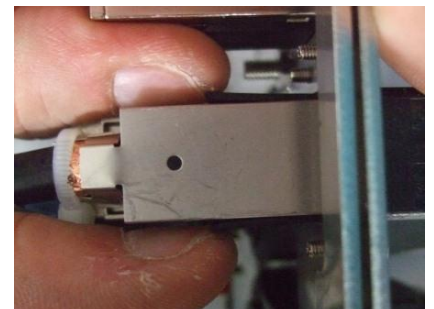

8. Remove the ground wire plate (M/C cable backward).

Hexagon socket head cap bolts: 2-M4×10

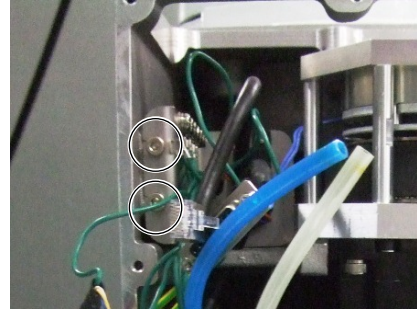

9. Remove the ground wire terminals.

Cross recessed head screws with washer

S, C models : 9-M4×8, 2-M3×6

P model : 10-M4×8, 2-M3×6

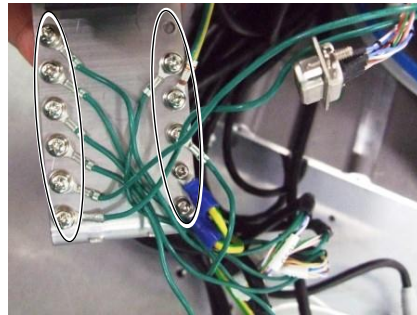

10. Remove the brake power supply.

Cross recessed head screws with washer: 2-M3×6

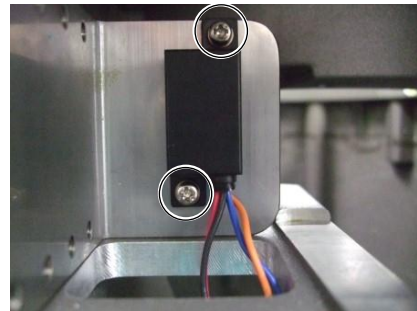

11. Disconnect the following cables through the opening of the base.

- D-sub cable
- Ground wire
- RJ45 connector
- F-sensor connector



12. Remove the Joint #1 motor unit.

For details, refer to *Maintenance: 5.1.1 Joint #1 - Replacing the Motor (M/C Cable Backward, Removal steps (6) and (7).*

13. Remove the plate for preventing cable interference.

Hexagon socket head cap bolts: 2-M3×6



14. Remove the base cable bracket (C1) and the cable protection sheet.

Hexagon socket head cap bolts: 2-M3×6



15. Remove the Joint #1 timing belt.

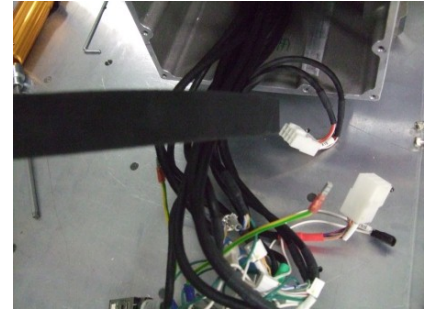

16. Remove the battery from the battery box.

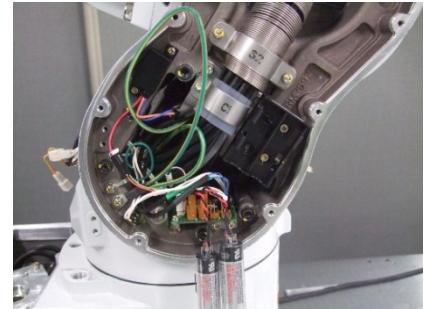

17. Disconnect the battery connector.

**NOTE**  Hold the board by hand and pull up the battery cable to disconnect the connector.

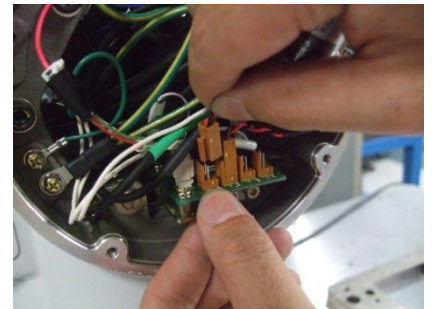

18. Remove the plate to which the battery board is fixed.

Hexagon socket head cap bolts: 2-M4×10

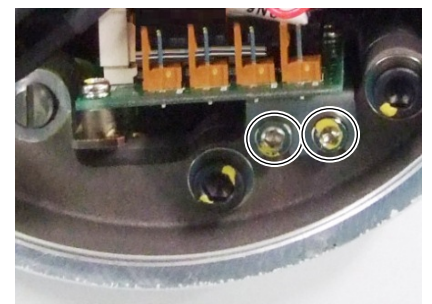

19. Disconnect the battery connectors.

Connectors: CN3, CN6

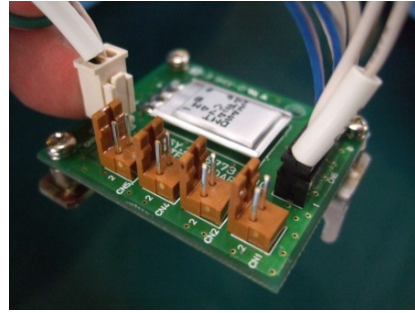

20. Remove the two ground wire terminals from the Arm #1.

Cross recessed head screws with washer: 2-M4×8



21. Remove the Joint #2 motor unit.

For details, refer to *Maintenance: 6.1 Joint #2 - Replacing the Motor*, Removal steps (1) to (3) and (5) to (9).

22. Cut off the wire tie that binds the cables inside the Arm #1 and remove the connector connected to the control board 1.

Connector: GS01

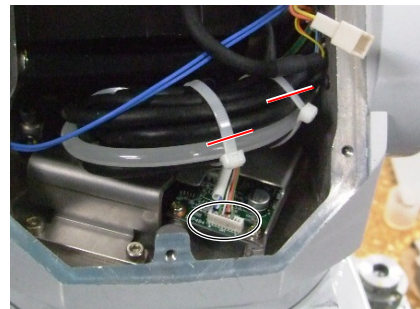

23. Remove the Joint #1 cable fixing plate (Arm #1 side).

Hexagon socket head cap bolts: 2-M4×10



24. Disconnect the internal cables from the base side to the Arm #1 side.  
Protect the connectors with masking tapes.

- To protect the connector's clips
- To avoid adherence of cable grease

NOTE  Disconnect the connectors one by one in order from the smallest connector to the largest one.





25. Remove the Arm #1 cable brackets (C1: 2 pieces) and cable protection tube.

Hexagon socket head cap bolts: 4-M3×6

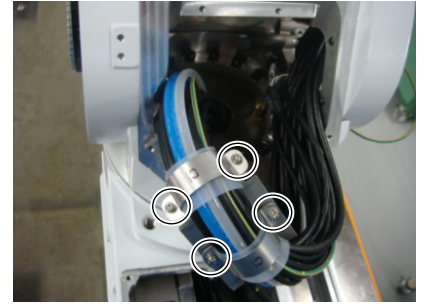

26. Remove the Arm #1 cable brackets (C2 and S2: one each) and cable protection tube.

Hexagon socket head cap bolts: 2-M3×6 (C2)  
2-M4×10 (S2)

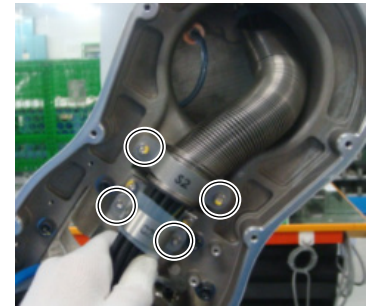

27. Remove the Arm #2 cable bracket (C2) and cable protection tube.

Hexagon socket head cap bolts: 2-M3×6

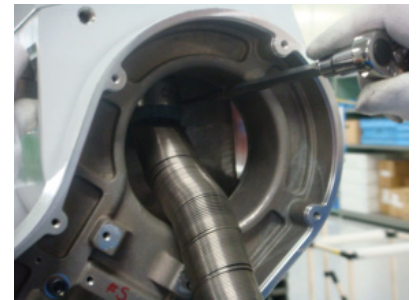

28. Remove the Arm #2 cable fixing plate.

Hexagon socket head cap bolts: 2-M4×10

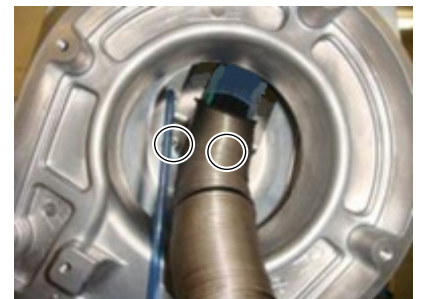

29. Cut off the wire tie that binds the cable protection coils inside the Arm #2.



30. Remove the two ground wire terminals from the Arm #2.

Cross recessed head screws with washer: 2-M4×8



31. Remove the Joint #3 motor unit.

For details, refer to *Maintenance: 7.1 Joint #3 - Replacing the Motor*, Removal steps (1) to (3) and (5) to (8).

32. Remove the two Arm #2 cable brackets (C3A and S3).

Hexagon socket head cap bolts: 2-M4×8 (C3A)  
2-M4×8 (S3)

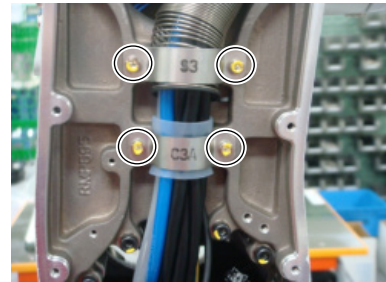

33. Remove the two air tubes inside the Arm #3.

Remove the air tube fittings from the air tubes.

The air tube fittings will be used again. Be careful not to lose them.

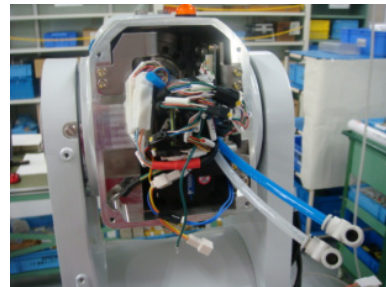

34. Remove the two ground wire terminals from the Arm #3.

Cross recessed head screws with washer: 2-M4×8

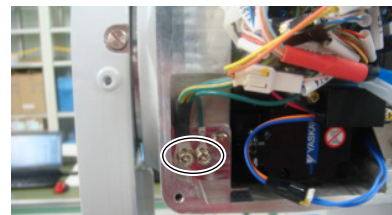

35. Disconnect the connectors inside the Arm #3.

Connectors: X141, X151, X161, BR041, BR051, X041, X71, X72, PS, LED, BT51, BT4  
(Hold the clip to remove.)

36. Remove the connector connected to the control board 2.

Connector: GS02

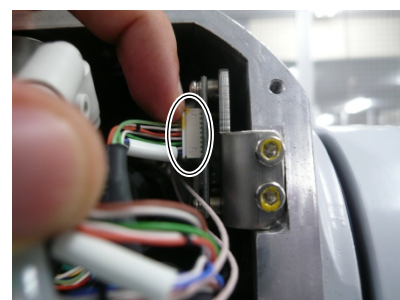

37. Remove the fixing plate of the Arm #3 control board 2.

Hexagon socket head cap bolts: 2-M4×10

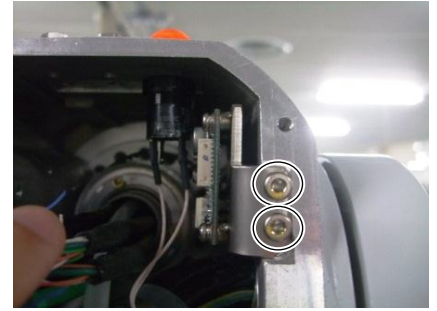

38. Remove the Arm #3 cable bracket (C3B).

Hexagon socket head cap bolts: 2-M3×6

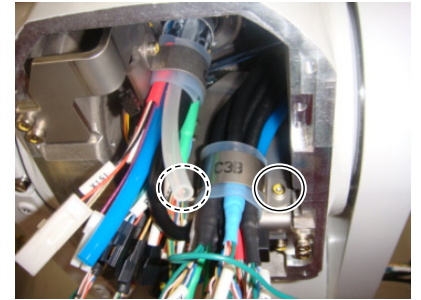

39. Remove the Arm #3 cable fixing plate 1.

Hexagon socket head cap bolts: 2-M4×10

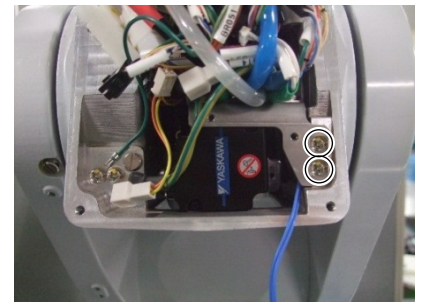

40. Cut off the wire tie that binds the cable protection coils inside the Arm #3.

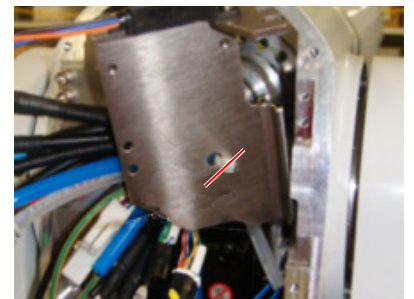

41. Disconnect the cables from the Arm #3 side to the Arm #2 side.



42. Pull out the separated cable unit (base side) from the Arm #1 side to the Arm #2 side.

To protect the connectors and facilitate the work, first cover the connectors with a plastic bag. Then, pass the cable unit through the arm.

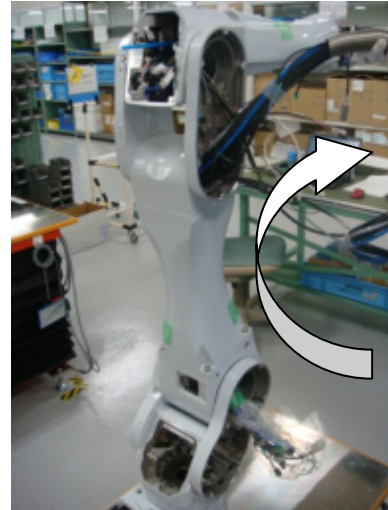

43. Remove the Arm #3 cable fixing plate 2.

Hexagon socket head cap bolts: 2-M4×10

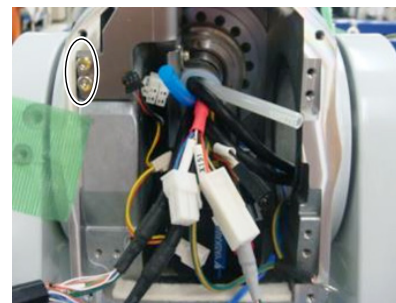

44. Remove the Arm #3 cable bracket (C4) and the cable protection sheet.

Hexagon socket head cap bolts: 2-M3×6

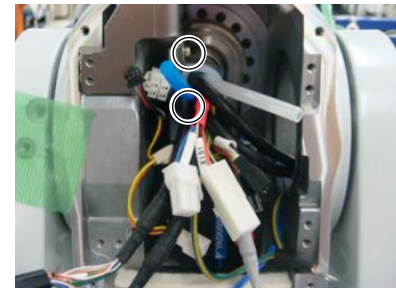

C8XL:

Remove the cable bracket (C4) and the cable protection sheet at the Arm #4 maintenance cover.

Hexagon socket head cap bolts: 2-M3×6





45. Remove the two air tubes inside the Arm #4.

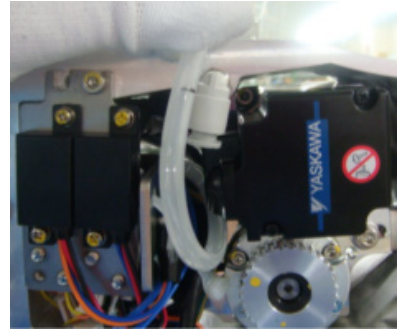
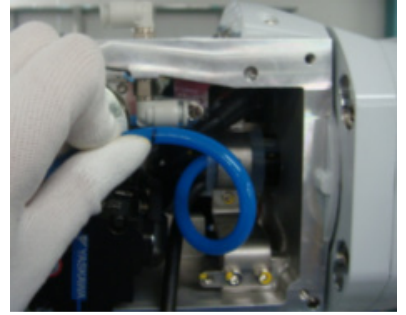

46. Cut off the wire tie that binds the cables of the Arm #4.

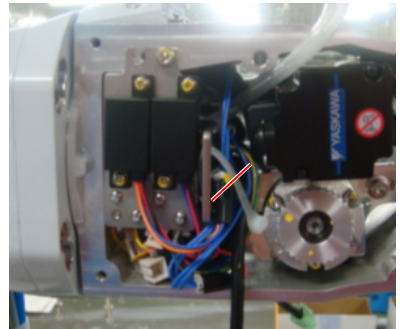

47. Loosen the bolts that fix the cable protection plate attached on the Arm #4, and disconnect the cables.

Hexagon socket head cap bolts: 2-M4×10

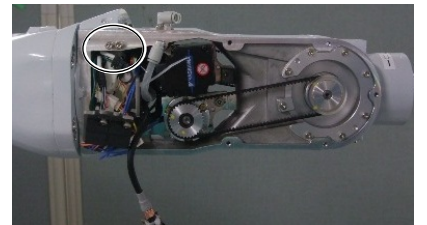

48. Remove the ground wire terminals from the cable protection plate.

Cross recessed head screws with washer: 4-M4×8

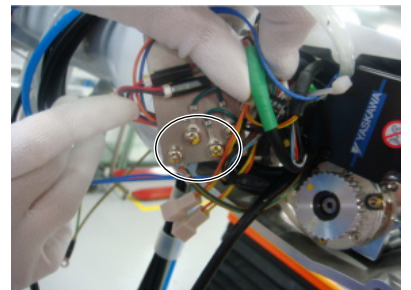

49. Remove the Joints #5 and #6 motor units.

For details, refer to *Maintenance: 9.1 Joint #5 - Replacing the Motor*, Removal steps (4) to (8), and *Maintenance: 10.1 Joint #6 - Replacing the Motor*, Removal steps (4) to (7).

The air tube fittings removed together with the Joint #5 motor unit will be used again.  
Be careful not to lose them.

50. Remove the Arm #4 D-sub attachment.

Hexagon socket head cap bolts: 2-M4×10

For details, refer to *Maintenance: 3. Covers*.



51. Remove the following parts from the Arm #4 D-sub attachment.

S, C models:

D-sub connector

D-sub connector fixing plate

P model:

D-sub connector

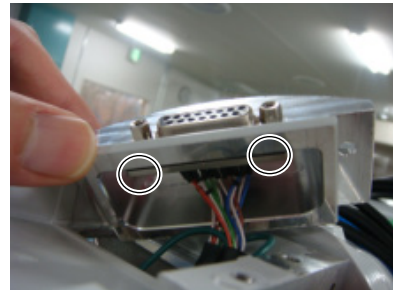

52. Remove the Arm #4 cable fixing plate.

Hexagon socket head cap bolts: 2-M4×10

53. Remove the cable bracket (C4).

Hexagon socket head cap bolts: 2-M3×6

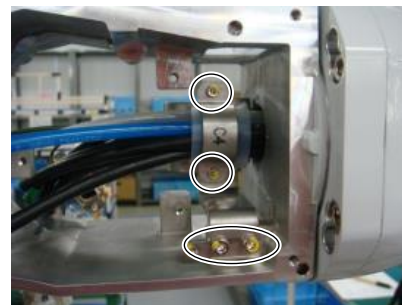

54. Disconnect the following cables that have no relays from the Arm #4 side to the Arm #3 side.

Ethernet cable

X052/X062 cable

Ground wire (green/yellow)

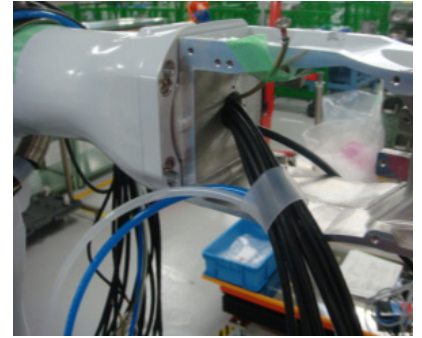

Installation: Cable unit (M/C cable backward)

1. Check if the cable unit contains the following parts.

Silicone sheet: 3 sheets (25 mm × 120 mm)

F-sensor connector housing 2 pieces

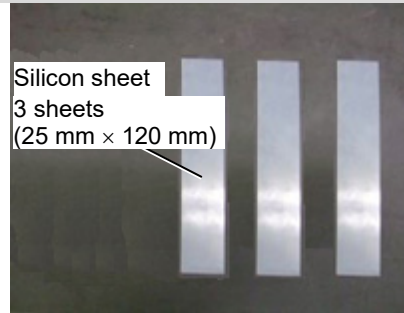

2. Remove the Ethernet cable from the connector.  
Protect the cable ends with masking tapes to prevent the clip from damage.

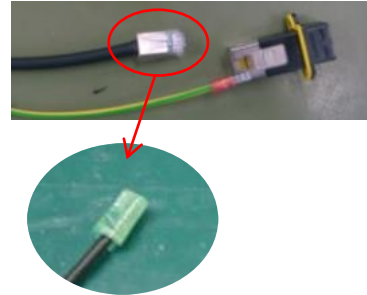

3. Remove the locking screws and nuts of the D-sub connector.

The screws and nuts will be used again for fixing the connector.  
Be careful not to lose them.



4. Disconnect the following connectors to separate the cables.

Connectors:

X051, X061, X151, X161, XGND, BR051, BR061,  
BT51, BT61, X71, X72, SW1



- Place a mark at the fixing position of each cable you are going to pass through the Arm #4.

D-sub	: 130 mm from the connector end
Other cables	: 190 mm from the connector end
Air tube	: 210 mm from the end

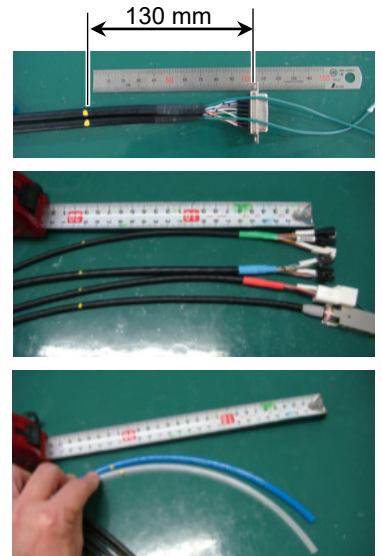

- Pass the separated cable unit (base side) from the Arm #2 to the Arm #1.

To protect the connectors and facilitate the work, first cover the connectors with a plastic bag. Then, pass the cable unit through the arm.



Pass the following cables that have no relays through the arm to the Arm #3 side.

- Ethernet cable
- X052/X062 cable
- Ground wire (green/yellow)



Leave out the other connector cables for a certain length, as shown in the photo, in order to store them in the Arm #3.



7. Pass the Ethernet cable, X052/X062 cable, and ground wire (green/yellow) from the Arm #3 side to the Arm #4 side.

C8/C8L:

Pass the cables one by one through the arm from the Arm #3 side.

C8XL:

First pass the braid tube from the Arm #4 side to the Arm #3 side. Insert the connectors through the braid tube, as shown in the photo, and fix the tube with the wire tie so that connectors are not to be pulled out. Then, pull the braid tube from the Arm #4 side while pushing the cables from the Arm #3 side to pass the cables through.

(See the photo.)



8. Pass the separated cable unit (Arm #4 side) from the Arm #4 to the Arm #3.

C8/C8L:

No silicone tube is provided.



C8XL:

Silicone tube is provided. Leave out the silicone tube on the Arm #4 side.

Pass the following cables through the silicone tube: Ethernet cable, X052/X062 cable, and ground wire (green/yellow) that have been passed from the Arm #3 side.





- NOTE  As shown in the photo, disconnect the Ethernet cable and air tube (blue) at one side of the Arm #4.  
Disconnect the remaining cables at the other side.

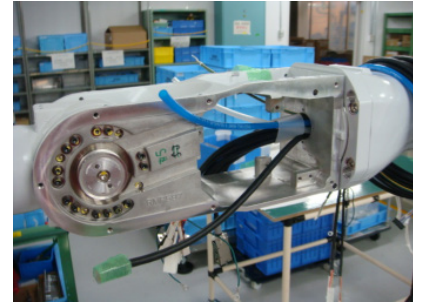

Align the marked positions and the position on the Arm #4 indicated with the arrow in the photo.

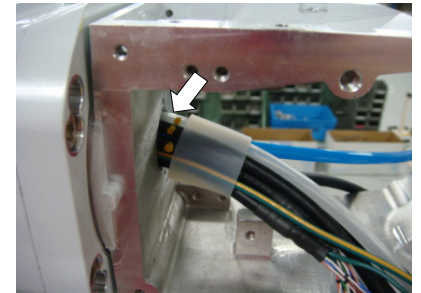

9. Install the cable fixing plate to the Arm #4.

Hexagon socket head cap bolts: 2-M4×10

Tightening torque:  $4.0 \pm 0.2$  N·m

10. Use a cable bracket (C4) to fix the cables.

Hexagon socket head cap bolts: 2-M3×6

Tightening torque:  $2.4 \pm 0.1$  N·m



C8/C8L:

Wrap the cables with the attached silicone sheet.

Use a cable bracket to fix the wrapped silicone sheet.

C8XL:

Place the silicone tube to the position where it is fixed with a cable bracket.

Use a cable bracket to fix the silicone tube.

11. Install the D-sub connector to the D-sub attachment of the Arm #4.

S, C models:

A D-sub connector fixing plate is provided.

Hold the D-sub connector between the D-sub attachment of the Arm #4 and the D sub connector fixing plate, and fix them with the locking screws removed in step 3 above. (The nuts and washers are not used.)



P model:

No D-sub connector fixing plate is provided.

The D-sub connector has screw holes.

Fix the D-sub connector using the locking screws removed in step 3 above.

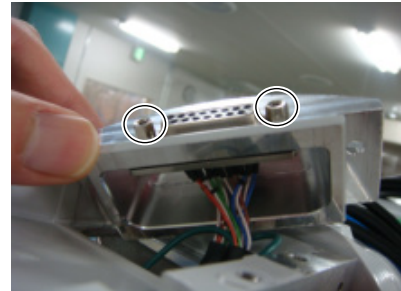

12. Install the D-sub attachment to the Arm #4.

Hexagon socket head cap bolts: 2-M4×10

Tightening torque:  $4.0 \pm 0.2 \text{ N}\cdot\text{m}$



Do not to let the cables caught in the attachment.

For details, refer to *Maintenance: 3. Covers.*





13. Install the motors for the Joints #5 and #6.  
Connect the cables and air tube and store them inside.

Upper photo: Joint #5 motor side

Place the Ethernet cable and the air tube (blue) on the near side.

Lower photo: Joint #6 motor side

Place the other cables and the air tube (clear) on the front side.

Fix the cables by binding them with a wire tie (INSULOC AB150 or equivalent) inserted through the hole of the cable fixing plate so that the cables do not interfere with the Joint #6 motor pulley.

Pay attention so that no connector is installed incorrectly and no cable is caught between components.

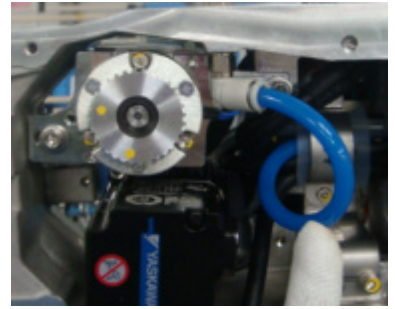

For details, refer to *Maintenance: 9.1 Joint #5 - Replacing the Motor*, Installation steps (4) to (8), and *Maintenance: 10.1 Joint #6 - Replacing the Motor*, Installation steps (4) and (7).

NOTE



Use the air tube fittings removed in the cable removal steps again.

14. Mount the brake power supply to the plate.  
Mount the power so that the cables are directed down.

Cross recessed head screws with washer: 4-M3×6

Tightening torque:  $0.45 \pm 0.1$  N·m

Installation locations:

Brake power supply for Joint #5: right side

Brake power supply for Joint #6: left side

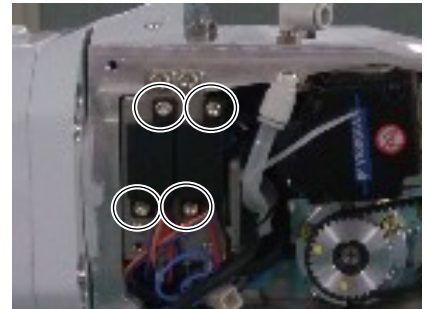

15. Fix the cable protection plate to the Arm #4.

Hexagon socket head cap bolts: 2-M4×10

Tightening torque:  $4.0 \pm 0.2$  N·m

NOTE



Be careful not to get the cables caught.  
It may cause cable breakage.

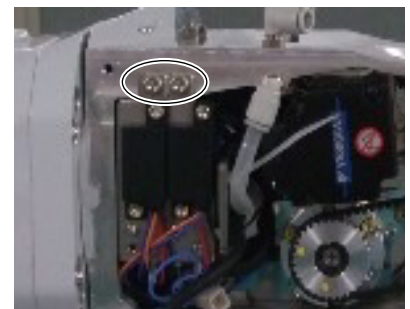

16. C8XL:

Fix the cables to the Arm #4 maintenance cover using a cable bracket (C4).

Wrap the cables with the attached silicone sheet.  
Use a cable bracket to fix the wrapped silicone sheet.

Hexagon socket head cap bolts: 2-M3×6  
Tightening torque:  $2.4 \pm 0.1 \text{ N}\cdot\text{m}$

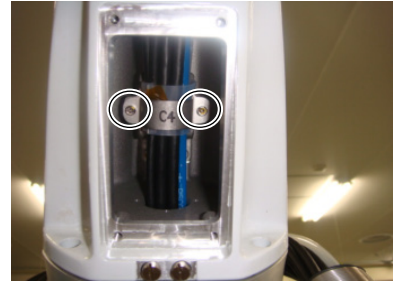

17. Apply grease to the cables in the sleeve.

Grease: Krytox  
Amount: C8/C8XL approximately 3g  
C8L: approximately 6g

Divide the above grease into halves and apply each half from the Arm #4 side and the Arm #3 side respectively.

Pay attention so that the grease does not get into the cable fixing area in the Arm #3 and connectors.

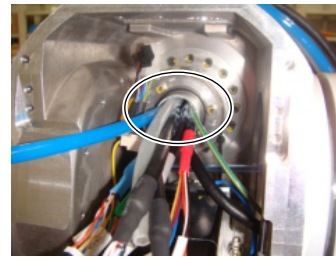
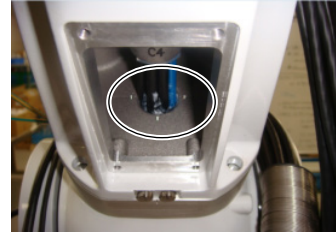

18. Use a cable bracket (C4) to fix the cables to the Arm #3 cable fixing plate 2.

Wrap the cables with the attached silicone sheet.  
Use a cable bracket to fix the wrapped silicone sheet.

Hexagon socket head cap bolts: 2-M3×6  
Tightening torque:  $2.4 \pm 0.1 \text{ N}\cdot\text{m}$

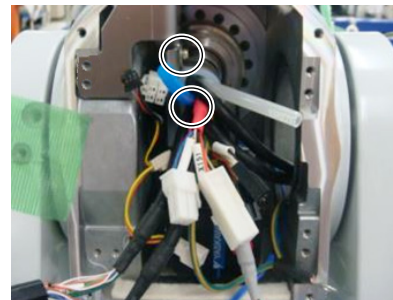

19. Install the Arm #3 cable fixing plate 2 to the Arm #3.

Hexagon socket head cap bolts: 2-M4×10  
Tightening torque:  $4.0 \pm 0.2 \text{ N}\cdot\text{m}$

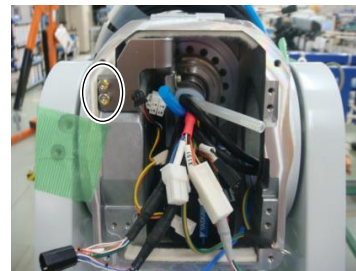

20. Use the cable protection spring to bind cables at the Arm #3 cable fixing plate 1.

Type of wire tie: AB100

Number of wire ties: 4

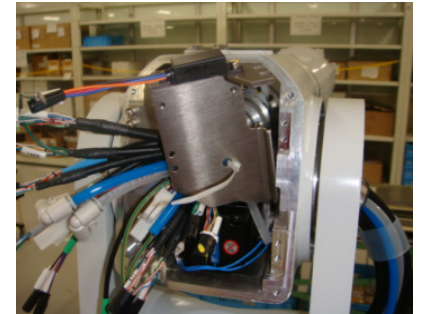
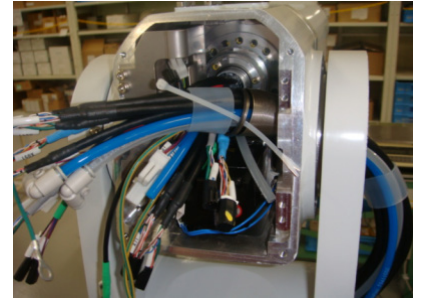

21. Install the Arm #3 cable fixing plate 1 to the Arm #3.

Hexagon socket head cap bolts: 2-M4×10

Tightening torque:  $4.0 \pm 0.2$  N·m

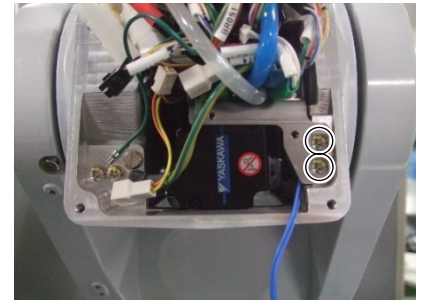

22. Use a cable bracket (C3B) to fix the cables.  
Place the two air tubes at the bottom part of the cables.  
Place the silicone tube to the position where it is fixed with a cable bracket.  
Use a cable bracket to fix the silicone tube.

Hexagon socket head cap bolts: 2-M3×6

Tightening torque:  $2.4 \pm 0.1$  N·m

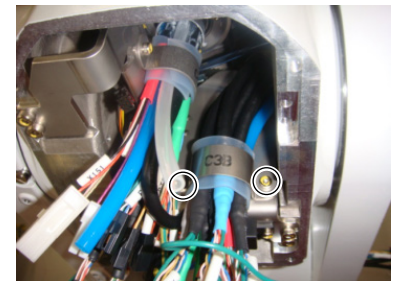

23. Install the control board 2 fixing plate to the Arm #3.

Hexagon socket head cap bolts: 2-M4×10

Tightening torque:  $4.0 \pm 0.2$  N·m

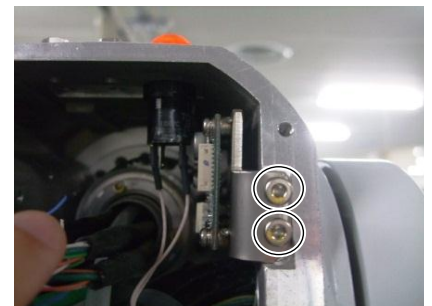

24. Connect the connector to the control board 2.

Connector: GS02

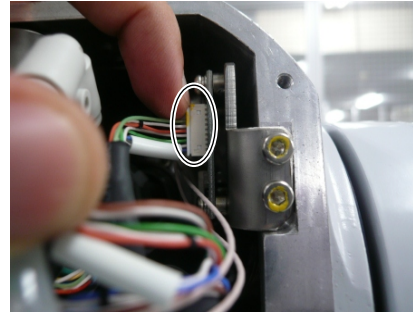

25. Connect the cable connectors inside the Arm #3.

Connectors: X141, X151, X161, BR041, BR051, X041, X71, X72, PS, LED, BT51, BT4  
(Hold the clip to remove.)

26. Install the two ground wire terminals to the Arm #3.

Green/yellow: Left side      Green: Right side

Cross recessed head screws with washer: 2-M4×8

Tightening torque:  $0.9 \pm 0.1$  N·m

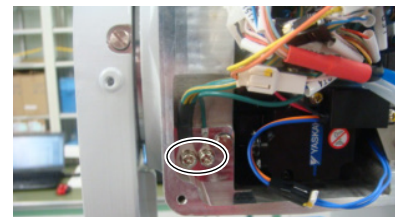

27. Use air tube fittings (elbows) to connect air tubes of the same color.

Remove the air tube fittings from the old cables to use them again.

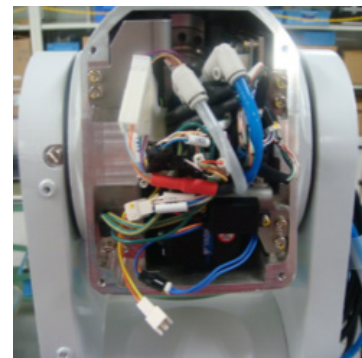

Adjust the connector protrusion so that the cover can be installed.

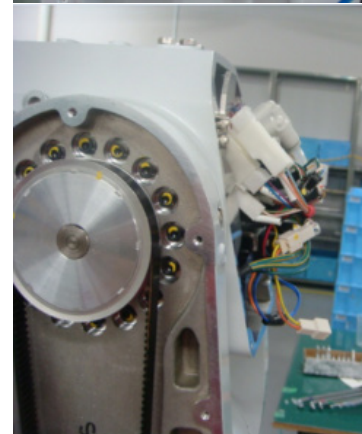



28. Use brackets (S3) to fix the cable protection spring to the Arm #2.

Hexagon socket head cap bolts: 2-M4×8

Tightening torque:  $4.0 \pm 0.2$  N·m

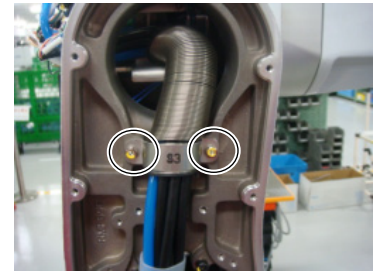

29. Use cable brackets (C3A) to fix the cables to the Arm #2 temporarily.

Place the silicone tube to the position where it is fixed with a cable bracket.

Use a cable bracket to fix the silicone tube temporarily.

Hexagon socket head cap bolts: 2-M4×8

Rough guide of temporary fixing:

The cables can be pushed up even after fixing the cables.

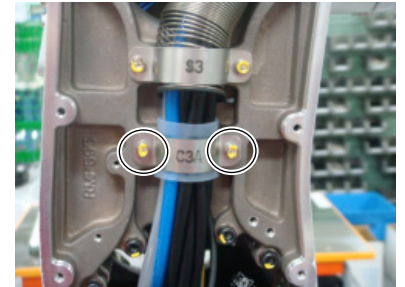

30. Push up the whole cables by 10 mm to the direction indicated with the arrow in the photo to allow for some space.

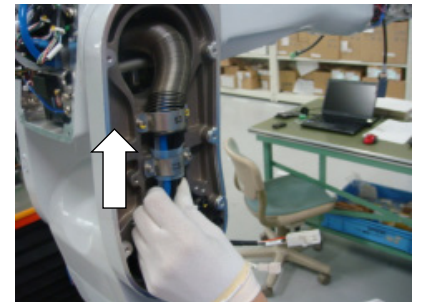

31. Fix the cables to the Arm #2 by fixing the cable brackets (C3A).  
Check that the silicone tube is not shifted away from the fixed position.

Hexagon socket head cap bolts: 2-M4×8

Tightening torque:  $4.0 \pm 0.2$  N·m

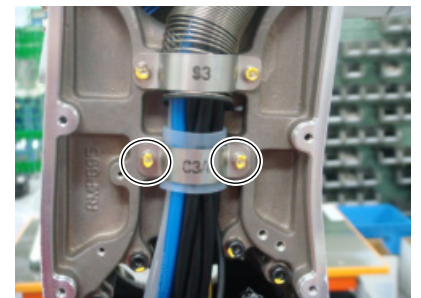

32. Install the Joint #3 motor unit.

For details, refer to *Maintenance: 7.1 Joint #3 - Replacing the Motor*, Installation steps (4) and (8).

33. Fix the two ground wire terminals to the Arm #2.

Green: Right side      Green/yellow: Left side

Cross recessed head screws with washer: 2-M4×8

Tightening torque:  $0.9 \pm 0.1$  N·m



34. Use the cable protection spring to bind cables at the Arm #2 cable fixing plate.

Type of wire tie: AB100

Number of wire ties: 4



Be careful of the orientation of the Arm #2 cable fixing plate. The side with two U-shaped grooves should be placed down.



35. Use cable brackets (C2) to fix the cables to the Arm #2 cable fixing plate temporarily.

Place the silicone tube to the position where it is fixed with a cable bracket.

Use a cable bracket to fix the silicone tube temporarily.

Hexagon socket head cap bolts: 2-M3×6

Rough guide of temporary fixing:

The cables can be pushed up even after fixing the cables.



36. Install the Arm #2 cable fixing plate to the Arm #2. After fitting the two U-shaped grooves to the fixing bolts, tighten the bolts.

Hexagon socket head cap bolts: 2-M4×10

Tightening torque:  $4.0 \pm 0.2$  N·m



37. Fix the cables to the Arm #2 cable fixing plate. Check that the silicone tube is not shifted away from the fixed position.

Hexagon socket head cap bolts: 2-M3×6

Tightening torque:  $2.4 \pm 0.1$  N·m

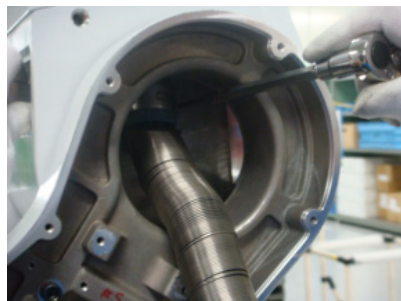

38. Use brackets (S2) to fix the cable protection spring to the Arm #1.

Hexagon socket head cap bolts: 2-M4×8

Tightening torque:  $4.0 \pm 0.2$  N·m



39. Use cable brackets (C2) to fix the cables to the Arm #2 temporarily.  
Place the silicone tube to the position where it is fixed with a cable bracket.

Use a cable bracket to fix the silicone tube temporarily.

Hexagon socket head cap bolts: 2-M3×6

Rough guide of temporary fixing:

The cables can be pushed up even after fixing the cables.



40. Push up the whole cables by 10 mm to the direction indicated with the arrow in the photo to allow for some space.

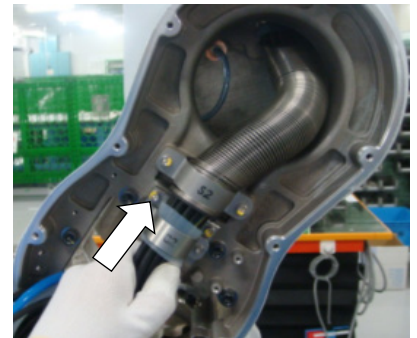

41. Fix the cables to the Arm #1.

Check that the silicone tube is not shifted away from the fixed position.

Hexagon socket head cap bolts: 2-M3×6

Tightening torque:  $2.4 \pm 0.1$  N·m



42. Place a mark at a position 250 mm from the cable bracket (C2).

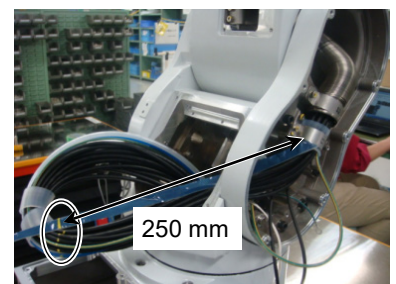

43. For the GS01 cable to be installed on the control board 1, place a mark at a position 130 mm from the connector.



44. For the X021, X121, BR021, and CN3 cables, place a mark at a position 160 mm from the connector respectively.



45. Use cable brackets (C1) to fix the cables to the Arm #1 cable fixing plate temporarily (2 positions).  
Temporarily fix the silicone tube by aligning its end to the mark.



Hexagon socket head cap bolts: 4-M3×6

Rough guide of temporary fixing:

The cables can be pushed up even after fixing the cables.

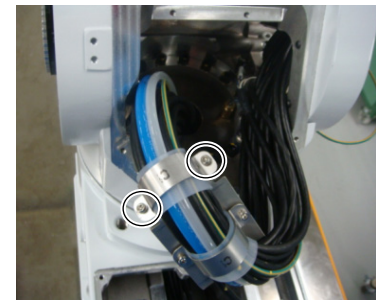



46. Fix the Arm #1 cable fixing plate temporarily to the Arm #1 and finely adjust the cable length.

Hexagon socket head cap bolts: 2-M4×10

Rough guide of temporary fixing: The plate should not move.

Notes for fine adjustment:

- No excess looseness or tension on the cables.
- The cables should not be pressed strongly against the arm edge.
- The X021, X121, BR021, and CN3 connectors should reach the end face of the Arm #1 when they are pulled out.
- The cables should not be too long.

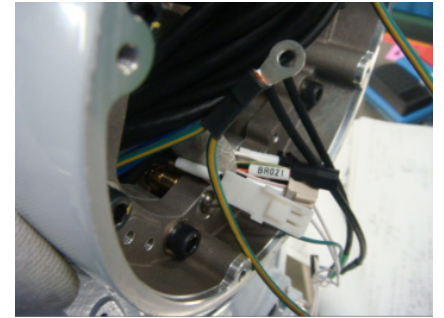
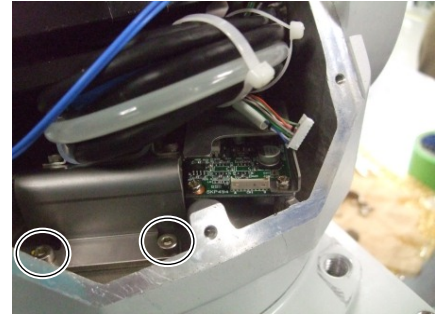

47. Place a mark on the cables at the sleeve outlet on the base side.



48. Fix the cable bracket (C1)-A on the near side so that the cable positions do not change.

Hexagon socket head cap bolts: 2-M3×6

Tightening torque:  $2.4 \pm 0.1$  N·m

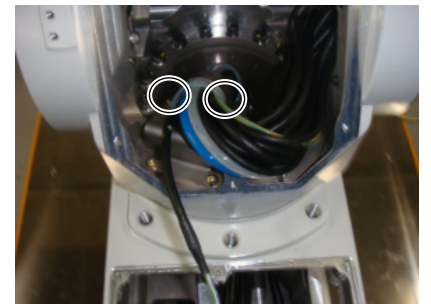

49. Remove the Arm #1 cable fixing plate fixed temporarily, and fix another cable bracket (C1)-B.

Removing Arm #1 cable fixing plate:

Hexagon socket head cap bolts: 2-M4×10

Fixing cable bracket (C1)-B:

Hexagon socket head cap bolts: 2-M3×6

Tightening torque:  $2.4 \pm 0.1$  N·m

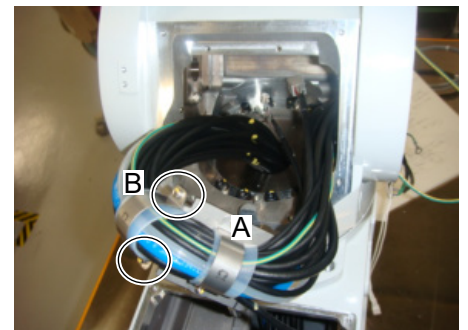

50. Apply grease to the cables inside the J1 sleeve.

Grease: Krytox

Amount: Approximately 7.5g

Application position:

Between fixing section of the bracket (C1) and the mark on the base side



51. Fix the Arm #1 cable fixing plate to the Arm #1.

Hexagon socket head cap bolts: 2-M4×10

Tightening torque:  $4.0 \pm 0.2$  N·m

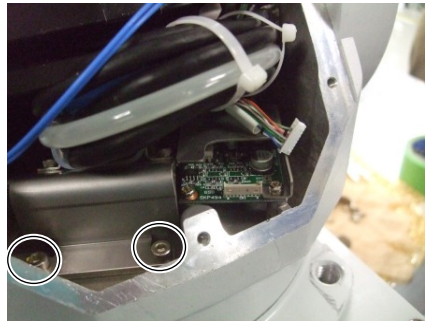

52. Install the connector GS01 to the control board 1.

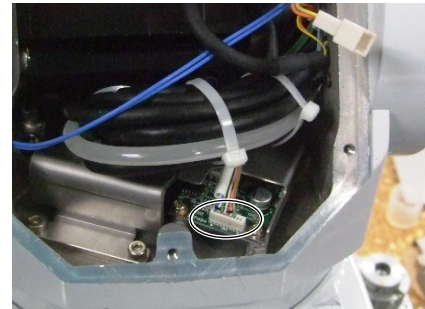

53. Install the Joint #2 motor and connect the connector.

For details, refer to *Maintenance: 6.1 Joint #2 - Replacing the Motor*, Installation steps (4) and (9).

54. Fix the two ground wire terminals to the Arm #2.

Green: Right side

Green/yellow: Left side

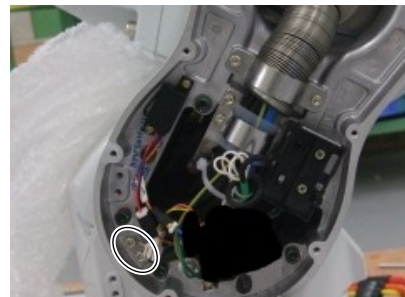

55. Connect the battery connectors.

Connectors: CN3, CN6

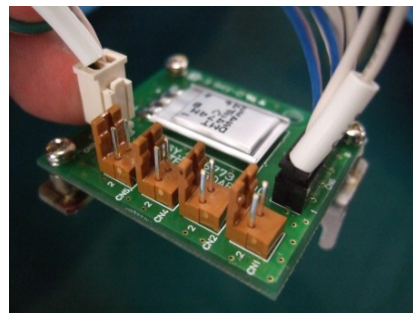

56. Install the battery board fixing plate.

Hexagon socket head cap bolts: 2-M4×10

Tightening torque:  $4.0 \pm 0.2$  N·m

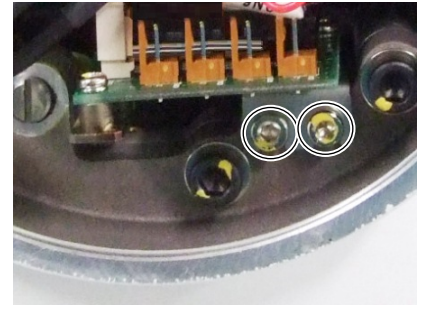

57. Connect the battery connectors.

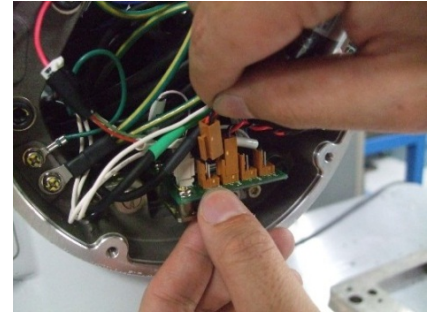

58. Install the battery to the battery box.

59. Pass the Joint #1 timing belt through the cable.



60. Use cable brackets (C1) to fix the cables to the base cable fixing plate.

Wrap the cables with the attached silicone sheet.

Use a cable bracket to fix the wrapped silicone sheet.

Hexagon socket head cap bolts: 2-M3×6

Tightening torque:  $2.0 \pm 0.1$  N·m



61. Install the plate for preventing cable interference.

Hexagon socket head cap bolts: 2-M3×6

Tightening torque:  $2.0 \pm 0.1$  N·m



62. Install the Joint #1 motor unit.

For details, refer to *Maintenance: 5.1.1 Joint #1 - Replacing the Motor (M/C Cable Backward)*, Installation steps (1) to (4).



63. Push out the following cables upward through the opening of the base.

- D-sub cable
- Ground wire
- RJ45 connector
- F-sensor connector



64. Install the brake power supply to the plate.  
The cables should be located in the direction as shown in the photo.  
(See the photo.)

- Cross recessed head screws with washer: 2-M3×6
- Tightening torque:  $0.45 \pm 0.1 \text{ N}\cdot\text{m}$

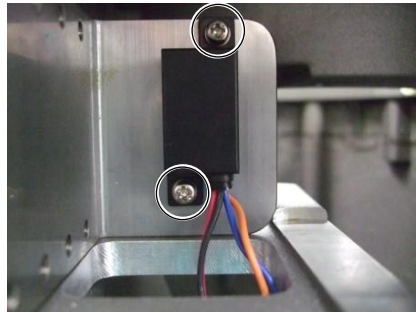

65. Install the ground wire terminals to the plate.

Cross recessed head screws with washer

S, C models :9-M4×8, 2-M3×6

P model :10-M4×8, 2-M3×6

Tightening torque : $0.9 \pm 0.1 \text{ N}\cdot\text{m}$  (M4×8)  
 $0.45 \pm 0.1 \text{ N}\cdot\text{m}$  (M3×6)

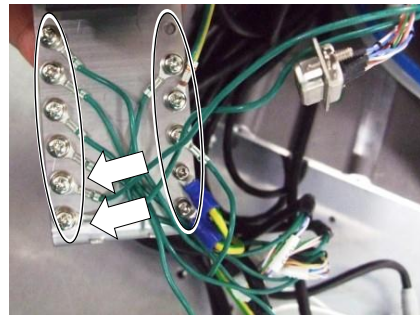

**NOTE**  The installation positions of the D-sub cable ground terminals are predetermined. Make sure to install them to the two screw holes on the backside of the Manipulator (indicated with arrows in the photo).

66. Install the ground wire plate (M/C cable backward).

Hexagon socket head cap bolts: 2-M4×10

Tightening torque:  $4.0 \pm 0.2 \text{ N}\cdot\text{m}$

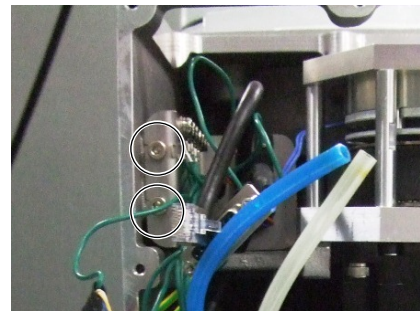

67. Install the following connectors according to the marks on the connector plate.

- RJ45 connector: Ether
- F-sensor connector: F-sensor

68. Connect the M/C cable connectors.

Connectors: X11, X12, X14, BR010, BR011, X010, X020,  
X040, LED, GS01, BT1



69. Install the D-sub connectors according to the marks on the connector plate.

Left: D-sub connector for brake release (with a wire marker: SW1): B-release

Right: D-sub connector for user wiring (without a wire marker: With round terminal): D-sub



70. Install the two air tubes according to the marks on the connector plate.

Air1: Clear

Air2: Blue

NOTE



Install the air tube with the correct color.

71. Install the covers and plate indicated below.

Arm #4 side covers (both sides)    Arm #4 maintenance cover (C8XL only)

Arm #3 cover    Arm #3 maintenance cover

Arm #2 side covers (both sides)    Arm #1 side covers (both sides)

Arm #1 center cover    Base maintenance cover

Connector plate (M/C cable backward)

For details, refer to *Maintenance: 3. Covers*.

72. Perform calibration.

For details, refer to *Maintenance: 16. Calibration*.

4.1.2 Replacing the Cable Unit (M/C Cable Downward)

	Name		Qty.	Note	
Maintenance Parts	Cable unit	C8-A701*B* (C8)	1	For standard, cleanroom models	2172929
			1	For protection model	2172932
		C8-A901*B* (C8L)	1	For standard, cleanroom models	2172930
			1	For protection model	2172933
		C8-A1401*B* (C8XL)	1	For standard, cleanroom models	2172931
			1	For protection model	2172934
	Belt tensile jig*		1	1674582	
	J1 brake positioning jig*		1	1675081	
	Wire tie	AB100	1	1675753	
		AB150	1	1675754	
Tools	Hexagonal wrench	width across flats: 2.5 mm	1	For M3 hexagon socket head cap bolts	
		width across flats: 3 mm	1	For M4 hexagon socket head cap bolts	
		width across flats: 4 mm	1	For M5 hexagon socket head cap bolts	
		width across flats: 5 mm	1	For M6 hexagon socket head cap bolts	
	Box wrench	width across flats: 5 mm	1	For D-Sub connector	
	Long nose pliers		1	For removing an air tube	
	Nippers		1	For cutting a wire tie	
	Cross-point screwdriver (#2)		1	For cross recessed head screws	
	Torque rench		1	For tightening torque control	
	Belt tension meter		1	Refer: Unitta U-505	

\* The belt tensile jig is an assembly jig. Use this jig when adjusting belt tension.

The brake is mounted on each joint to prevent the arm from lowering due to its own weight while the Controller power is OFF or the motor is OFF status. The brake does not work during replacement. Be careful when performing maintenance work.

When removing the Joint #2 motor, tilt the Arm #2 and press it against the Arm #1.

Reference: *Maintenance: 6.1 Joint #2 - Replacing the Motor*; Removal step (2)

When removing the Joint #3 motor, tilt the Arm #3 and press it against the Arm #2.

Reference: *Maintenance: 7.1 Joint #3 - Replacing the Motor*; Removal step (2)

When pressing the arm, put a piece of cloth or a similar material between the arms to avoid contacting each other. This protects the arm surfaces from scratching and paint peeling off.

## Removal: Cable unit (M/C cable downward)

1. Move the Manipulator to the origin posture (0 pulse position).
2. Turn OFF the Controller.
3. Turn the Manipulator laterally.



CAUTION

- When turning the Manipulator laterally, there must be two or more people to work on it so that at least one of them can support the arm while the others are removing the bolts.  
Removing the bolts without supporting the arm may result in the arm falling, bodily injury, and/or malfunction of the robot system.

4. Remove the covers and plate indicated below.
 

Arm #4 side covers (both sides)	Arm #4 maintenance cover (C8XL only)
Arm #3 cover	Arm #3 maintenance cover
Arm #2 side covers (both sides)	Arm #1 side covers (both sides)
Arm #1 center cover	Base cover (M/C cable downward)
Base maintenance cover	Connector plate (M/C cable downward)

For details, refer to *Maintenance: 3. Covers*.

5. Remove the two air tubes in the base.
6. Remove the two D-sub connectors.
7. Disconnect the cable from the base and disconnect the following connectors.

Connectors: X11, X12, X14, BR010, BR011, X010, X020,  
X040, LED, GS01, BT1  
(Hold the clip to remove.)



8. Disconnect the following connectors.

RJ45 connector:

Hold the clip to remove.



F-sensor connector:

Open the clips on the both ends of the connector and pull it out.

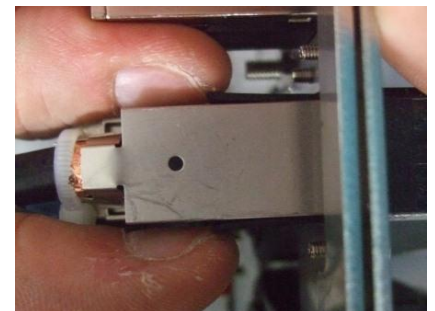

9. Remove the ground wire terminals.

Cross recessed head screws with washer

S, C models: : 9-M4×8, 2-M3×6

P model : 10-M4×8, 2-M3×6

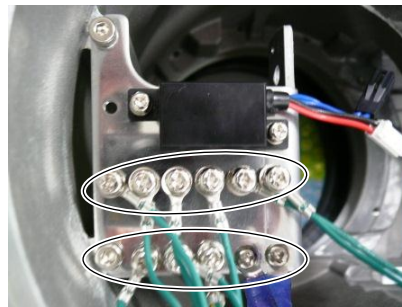

10. Remove the brake power supply.

Cross recessed head screws with washer: 2-M3×6

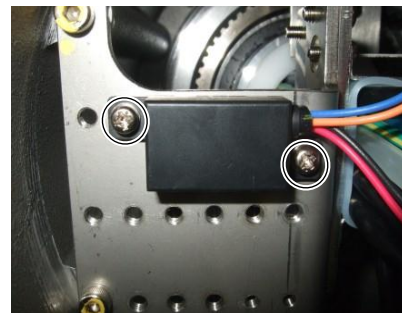

11. The subsequent steps are the same as those for the M/C cable (backward).

For details, refer to *Maintenance: 4.1.1 Replacing the Cable Unit (M/C Cable Backward)*, Removal steps (13) to (54).



## Installation: Cable unit (M/C cable downward)

1. Perform the installation steps (1) to (62) of *Maintenance: 4.1.1 Replacing the Cable Unit (M/C Cable Backward)*.
2. Turn the Manipulator laterally.

 <b>CAUTION</b>	<p>■ When turning the Manipulator laterally, there must be two or more people to work on it so that at least one of them can support the arm while the others are removing the bolts.</p> <p>Removing the bolts without supporting the arm may result in the arm falling, bodily injury, and/or malfunction of the robot system.</p>
---	--

3. Install the brake power supply to the plate.  
The cables should be located in the direction as shown in the photo.  
(See the photo.)

Cross recessed head screws with washer: 2-M3×6

Tightening torque:  $0.45 \pm 0.1 \text{ N}\cdot\text{m}$

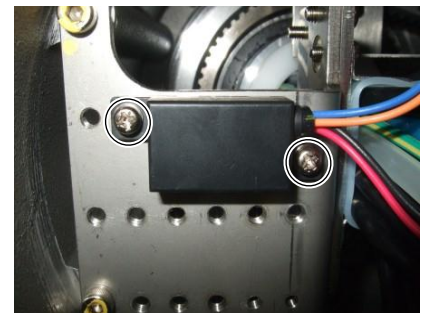

4. Install the ground wire terminals to the plate.

Cross recessed head screws with washer

S, C models: : 9-M4×8, 2-M3×6

P model : 10-M4×8, 2-M3×6

Tightening torque :  $0.9 \pm 0.1 \text{ N}\cdot\text{m}$  (M4×8)

$0.45 \pm 0.1 \text{ N}\cdot\text{m}$  (M3×6)

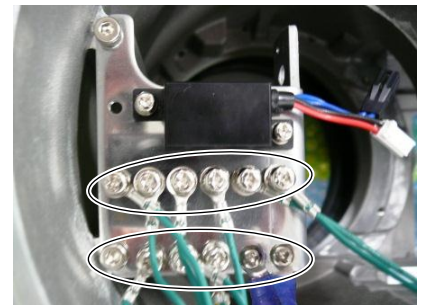

5. Install the following connectors according to the marks on the connector plate.

RJ45 connector: Ether

F-sensor connector: F-sensor

6. Connect the M/C cable connectors.

Connectors: X11, X12, X14, BR010, BR011, X010, X020, X040, LED, GS01, BT1

7. Install the D-sub connectors according to the marks on the connector plate.

Left: D-sub connector for brake release (with a wire marker: SW1): B-release

Right: D-sub connector for user wiring (without a wire marker: With round terminal): D-sub

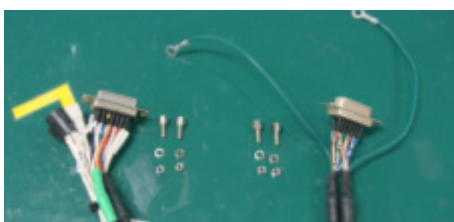

8. Install the two air tubes according to the marks on the connector plate.

Air1: Clear

Air2: Blue

NOTE



Install the air tube with the correct color.

9. Install the following covers and plate.

Arm #4 side covers (both sides)    Arm #4 maintenance cover (C8XL only)

Arm #3 cover    Arm #3 maintenance cover

Arm #2 side covers (both sides)    Arm #1 side covers (both sides)

Arm #1 center cover    Base cover (M/C cable downward)

Base maintenance cover    Connector plate (M/C cable downward)

For details, refer to *Maintenance: 3. Covers*.

10. Perform calibration.

For details, refer to *Maintenance: 16. Calibration*.

## 4.2 Connector Pin Assignment

### 4.2.1 Signal Cable

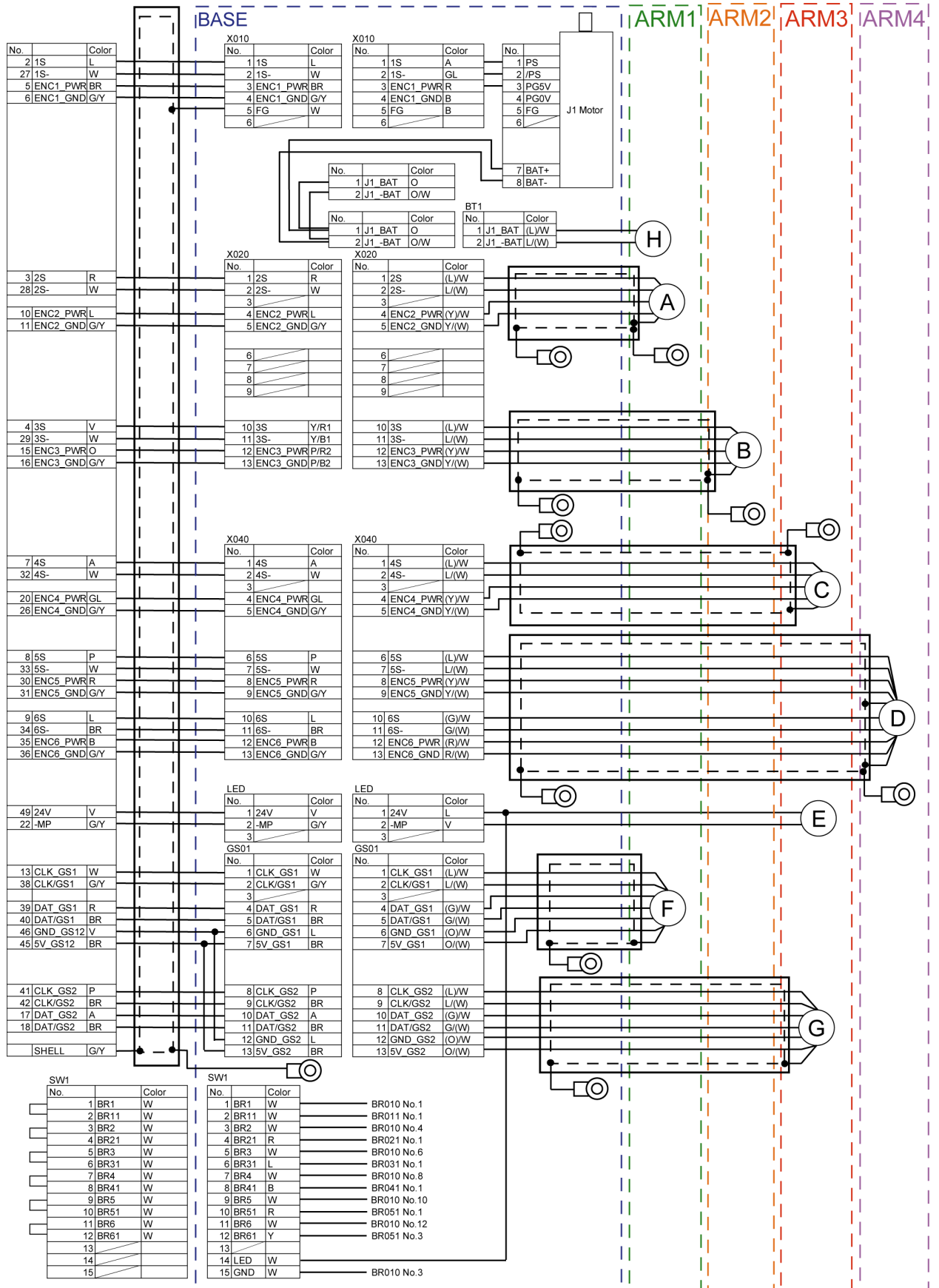

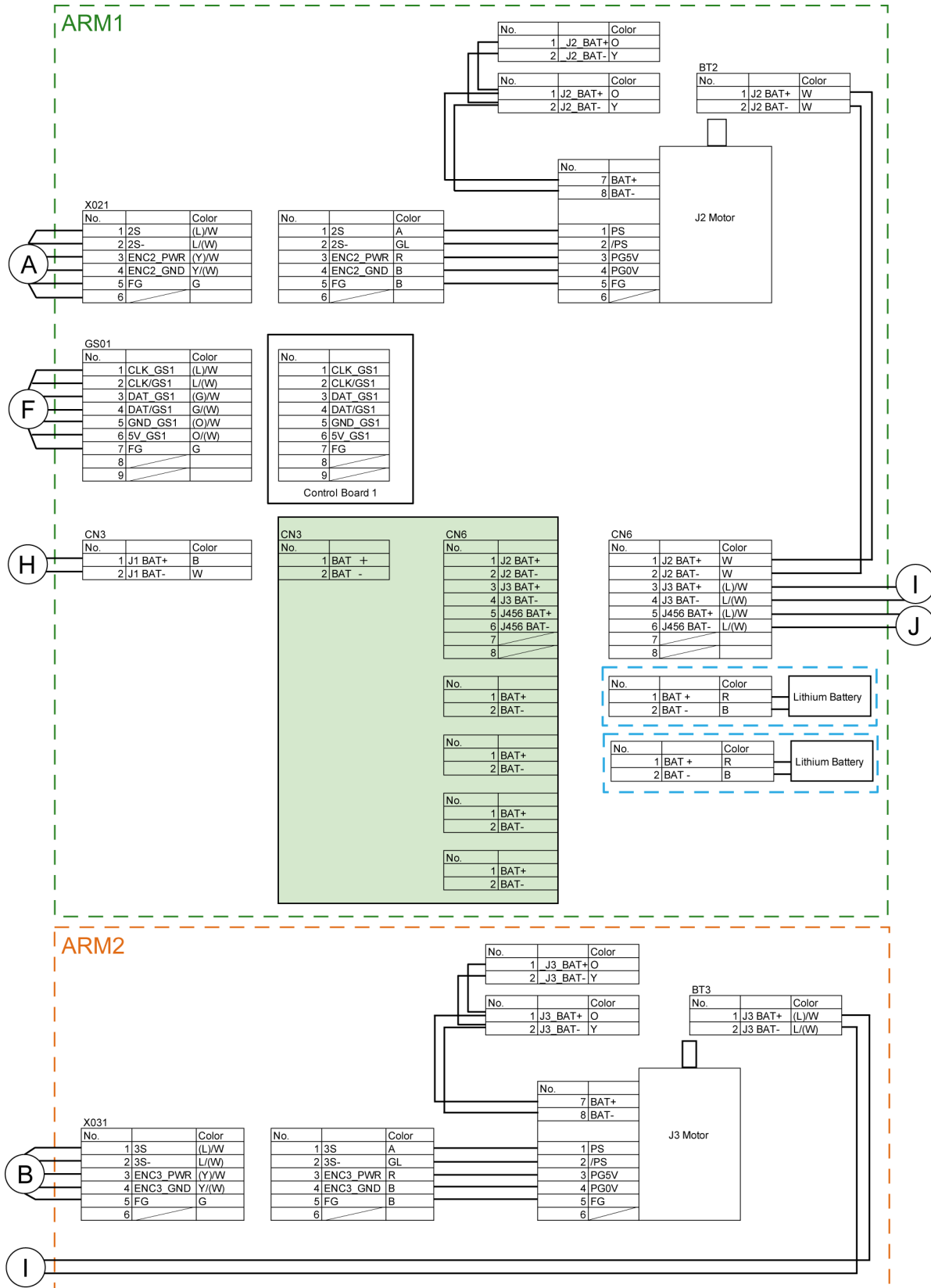

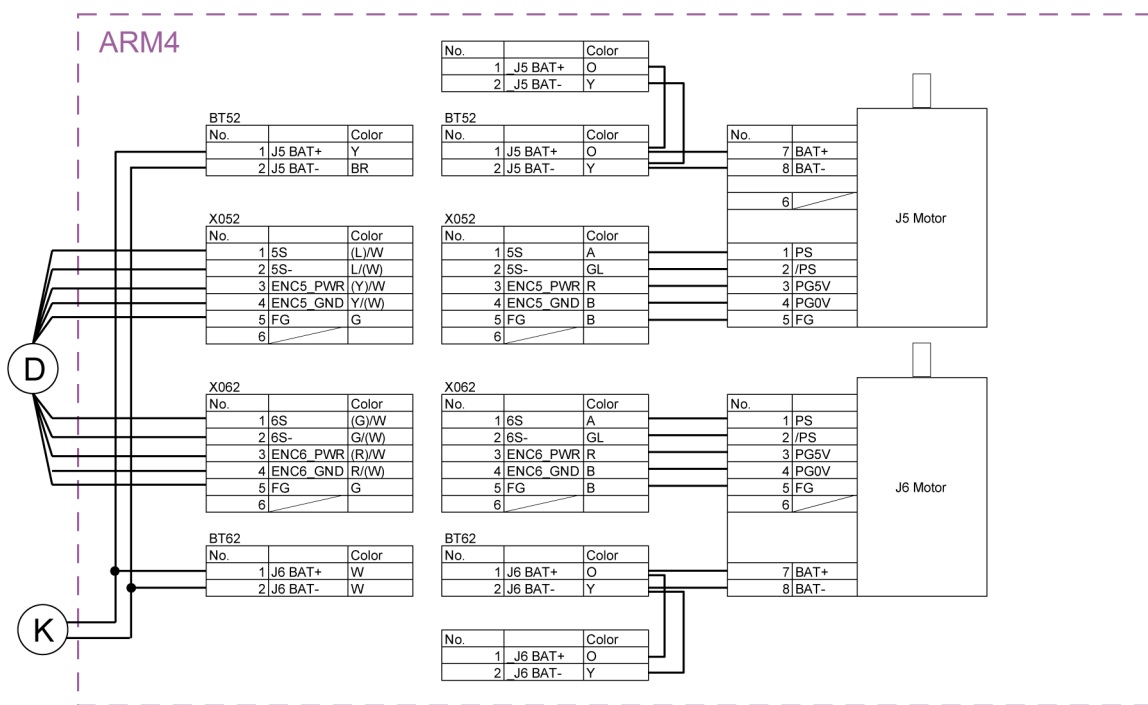
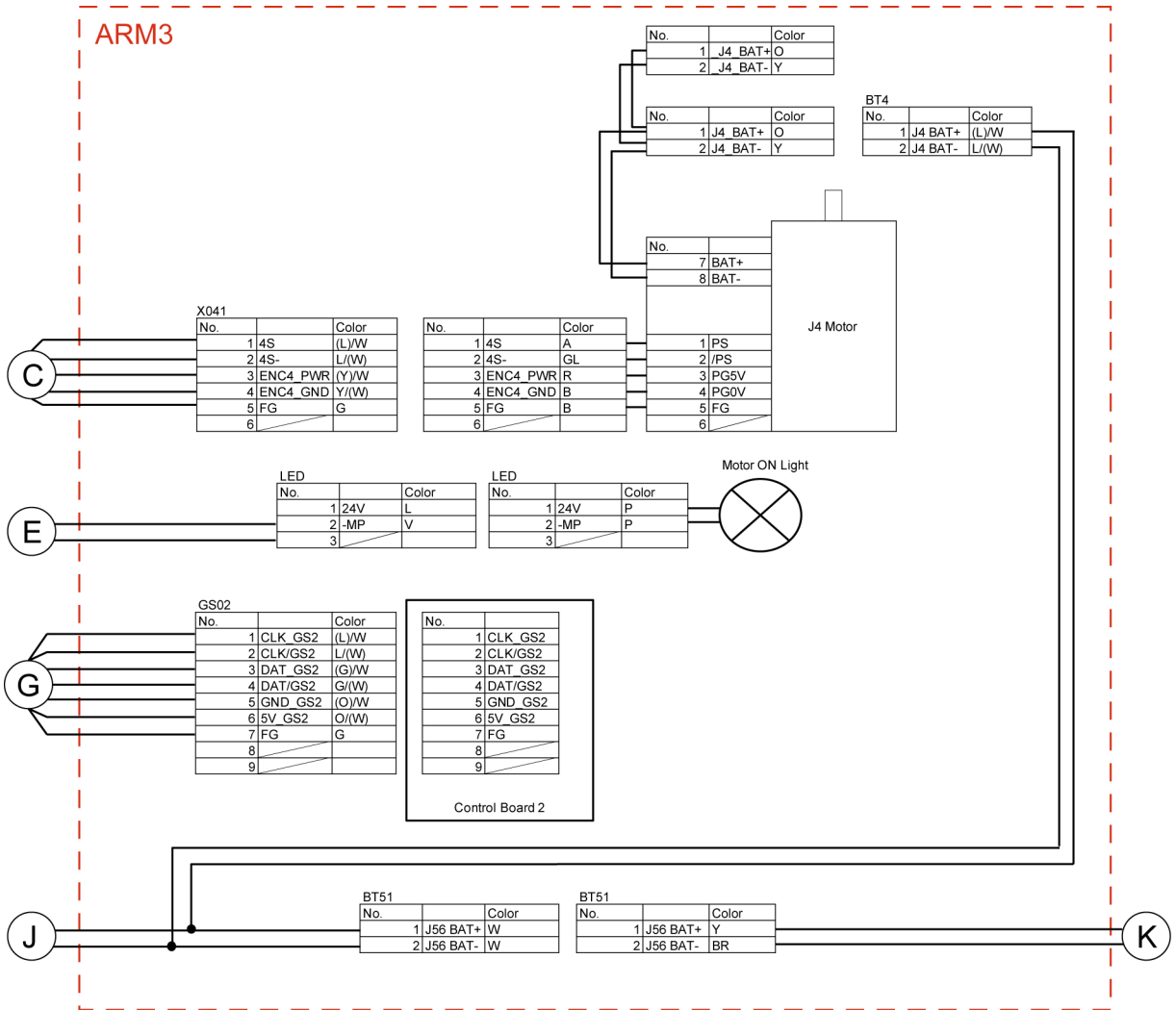

4.2.2 Power Cable

C8-A701\*\*\* (C8), C8-A901\*\*\* (C8L)

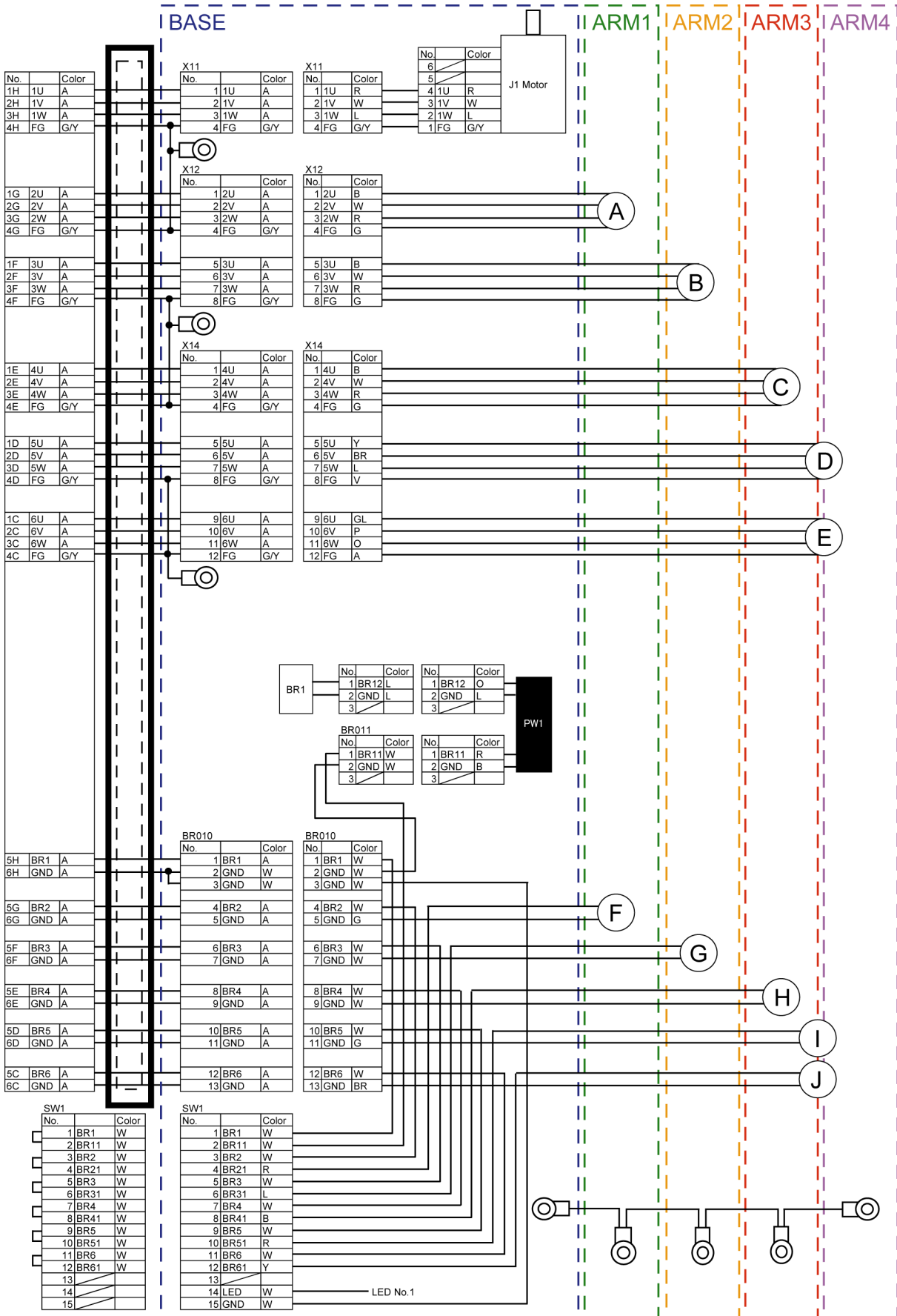

C8-A1401\*\*\* (C8XL)

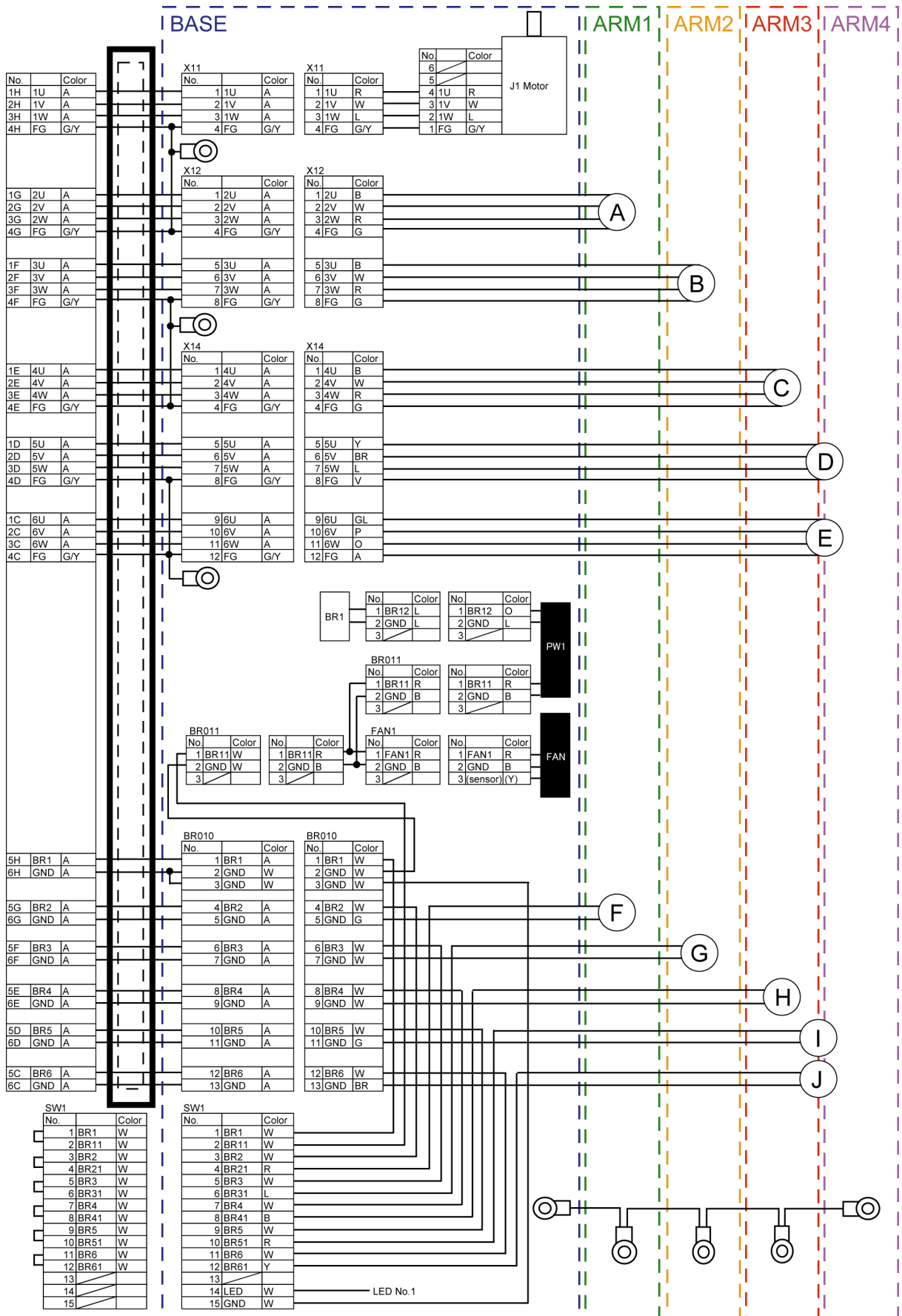

C8-A701\*\*\* (C8), C8-A901\*\*\* (C8L), C8-A1401\*\*\* (C8XL)

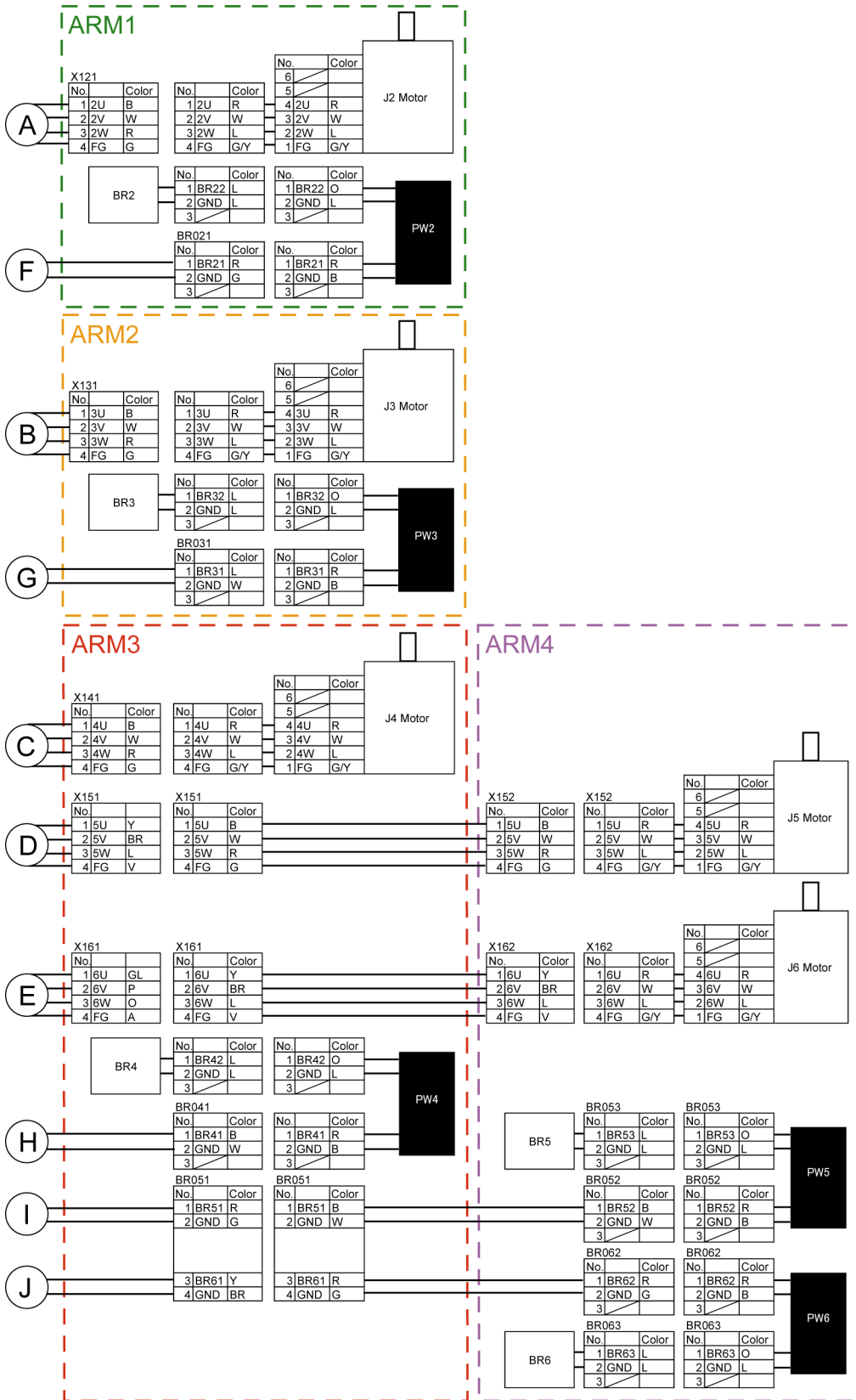



### 4.2.3 User Cable

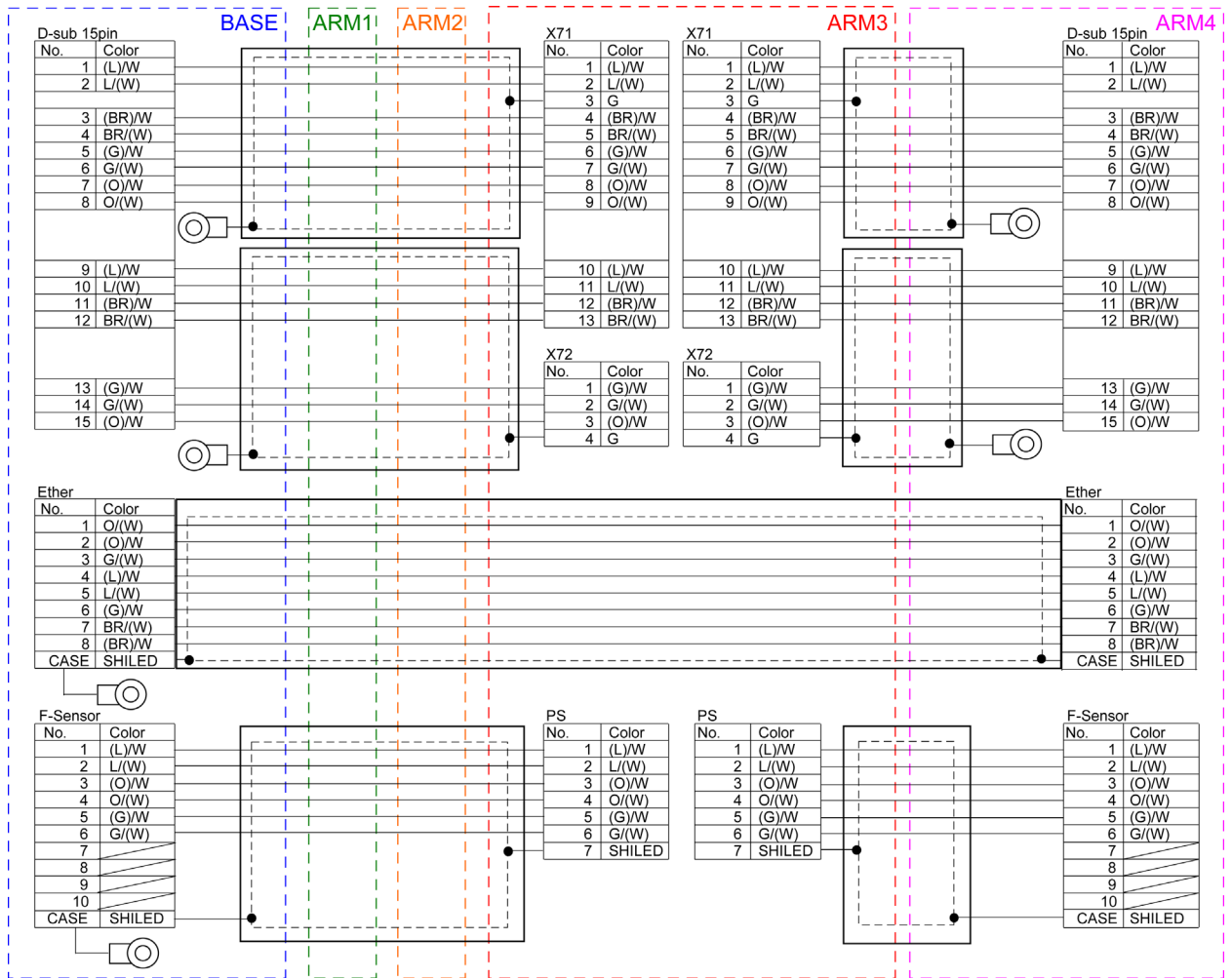

### 4.2.4 Color of Cables

The following table shows the codes and cable colors indicated in the pin assignments

4.2.1 Signal Cable

4.2.2 Power Cable

4.2.3 User Cable

Code	Cable color
B	Black
W	White
R	Red
G	Green
Y	Yellow
BR	Brown
L	Blue
V	Violet
A	Azure
O	Orange
GL	Gray
P	Pink

## 5. Joint #1

 WARNING	<ul style="list-style-type: none"> <li>■ Before performing any replacement procedure, turn OFF the Controller and related equipment, and then disconnect the power plug from the power source. Performing any replacement procedure with the power ON is extremely hazardous and may result in electric shock and/or malfunction of the robot system.</li> <li>■ Do not connect or disconnect the motor connectors while the power to the robot system is turned ON. Connecting or disconnecting the motor connectors with the power ON is extremely hazardous and may result in serious bodily injury as the Manipulator may move abnormally, and also may result in electric shock and/or malfunction of the robot system.</li> <li>■ Be sure to connect the AC power cable to a power receptacle. DO NOT connect it directly to a factory power source. To shut off power to the robot system, disconnect the power plug from the power source. Performing any work while connecting the AC power cable to a factory power source is extremely hazardous and may result in electric shock and/or malfunction of the robot system.</li> </ul>
--	---

 CAUTION	<ul style="list-style-type: none"> <li>■ Be careful not to apply excessive shock to the motor shaft during replacement procedures. The shock may shorten the life of the motors and encoder and/or damage them.</li> <li>■ Never disassemble the motor and encoder. Disassembled motor and encoder will cause a positional gap and cannot be used again.</li> </ul>
---	---

After parts have been replaced (motors, reduction gear units, timing belts, etc.), the Manipulator cannot perform positioning properly because a gap exists between the origin stored in each motor encoder and its corresponding origin stored in the Controller.

After replacing the parts, it is necessary to match these origins.

The process of aligning the two origins is called “Calibration”.

Refer to *Maintenance 16. Calibration* and follow the steps to perform calibration.

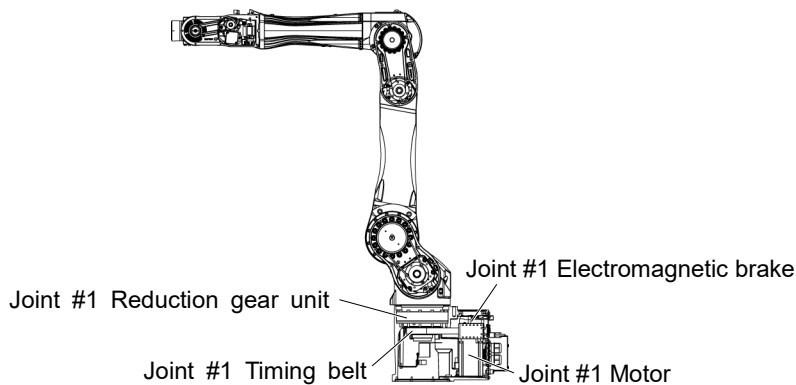

(Figure: C8-A1401\* (C8XL))

Maintenance procedures differ depending on the installation type of the M/C cable.

- 5.1 M/C Cable Backward (Joint #1)
- 5.2 M/C Cable Downward (Joint #1)

## 5.1 M/C Cable Backward (Joint #1)

### 5.1.1 Joint #1 - Replacing the Motor (M/C Cable Backward)

	Name		Qty.	Note	
Maintenance Parts	Motor unit (Joint #1)	C8-A701** (C8)	1	2172921	
		C8-A901** (C8L)			
		C8-A1401** (C8XL)	1	2172922	
		Belt tensile jig*		1	1674582
		J1 brake positioning jig*		1	1675081
	Wire tie	AB100		-	1675753
		AB350		-	1697428
Tools	Hexagonal wrench	width across flats: 3 mm	1	For M4 hexagon socket head cap bolts	
		width across flats: 4 mm	1	For M5 hexagon socket head cap bolts	
		width across flats: 5 mm	1	For M6 hexagon socket head cap bolts	
	Cross-point screwdriver (#2)		1	For cross recessed head screws	
	Torque wrench		1	For tightening torque control	
	Nippers		1	For cutting the wire tie	
	Pliers		1	For tightening the wire tie	
	Belt tension meter		1	Refer: Unitta U-505	

\* The belt tensile jig and J1 brake positioning jig are assembly jigs. Use these jigs in relevant maintenance steps.

The brake is mounted on each joint to prevent the arm from lowering due to its own weight while the Controller power is OFF or the motor is OFF status. The brake does not work during replacement. Be careful when performing maintenance work.

Removal: Joint #1 Motor (M/C Cable Backward)

1. Turn OFF the Controller.
2. Remove the base maintenance cover.  
For details, refer to *Maintenance: 3. Covers*.
3. Remove the connector plate (M/C cable backward).  
For details, refer to *Maintenance: 3. Covers*.
4. Disconnect the cables from the base and disconnect the connectors.  
Connector: X11, X010, BT1, BR011  
(Hold the clip to remove.)



C8-A701\*\* (C8) C8-A901\*\* (C8L)

**NOTE**  When replacing only the brake, do not disconnect the connector BT1. If the connector is disconnected, perform calibration.

C8-A1401\*\* (C8XL):

Remove the heat radiation block

1. Remove the wire tie and the bolts to remove the heat radiation block  
Hexagon socket head cap bolts: M5×15  
Wire tie: AB350
2. Remove the heat radiation sheet between the heat radiation block and the motor.

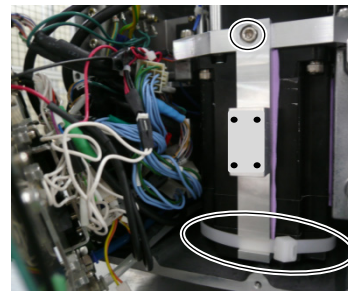

C8-A1401\*\* (C8XL)

**NOTE**  The heat radiation block, the heat radiation sheet, and the bolts will be used again. Be careful not to lose them.

Be careful not to tear the heat radiation sheet.

5. Remove the brake power supply.  
Cross recessed head screws with washer: 2-M3×6

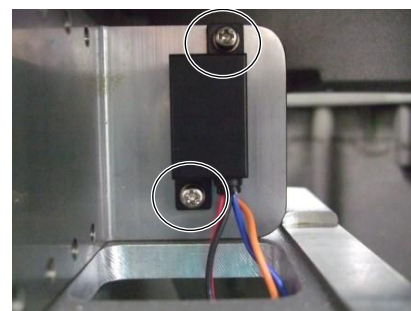

6. Remove the Joint #1 brake plate from the Joint #1 motor unit.

Hexagon socket head cap bolts: 3-M4×20

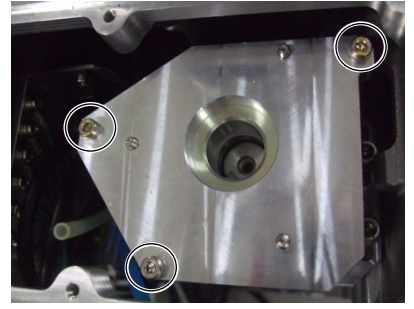

7. Remove the Joint #1 motor unit from the base.

Hexagon socket head cap bolts: 3-M6×30 (with a plain washer)

Be careful not to tear and lose the heat radiation sheet attached to the motor.



Installation: Joint #1 Motor (M/C Cable Backward)

1. Put the Joint #1 timing belt on the Joint #1 pulley 2 of the Joint #1.

Hold the belt so as not to drop it.



2. Check that the heat radiation sheet is attached on the right side of the motor (when seeing from the rear side of the Manipulator).

**NOTE** If the Manipulator is operated without the heat radiation sheet, the motor generates heat and the error may occur.  
If the heat radiation sheet has the protection film, remove the film.

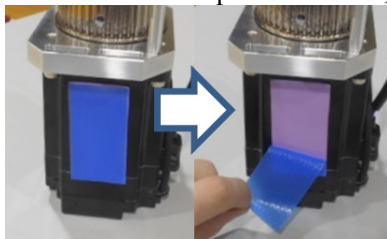

Pass the pulley 1 of the Joint #1 motor unit to the Joint #1 timing belt and loosely secure it to the base.

Hexagon socket head cap bolts: 3-M6×30 (with a plain washer)



Make sure that the gear grooves of the timing belt are fit into those of the pulley completely.

When securing the motor unit loosely, make sure that the motor unit can be moved by hand and it does not tilt when being pulled.

If the unit is secured too loose or too tight, the belt will not have proper tension.

3. Apply proper tension to the Joint #1 motor unit and secure it.  
When securing the motor unit, attach the heat dissipation sheet to the right side of the base (when seeing from the rear side of the Manipulator).

Joint #1 timing belt tension: 89 to 149 N

Belt tension meter setting values

Weight: 4.0 g/mm width × m span, Width: 20 mm, Span: 160 mm

Hexagon socket head cap bolts: 3-M6×30 (with a plain washer)

Tightening torque:  $13.0 \pm 0.6$  N·m

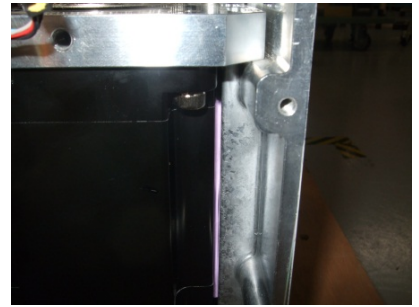

**NOTE** Regarding belt tension:



- Jumping (position gap) may occur if the value is below the lower limit.
- Vibration (abnormal noise) or reduction in life of the parts may occur if the value exceeds the upper limit.
- When you replace with a new belt, belt extends and the belt tension may decrease in the initial stage.  
Make sure to operate the robot two to three days and check the belt tension again.

When using the belt tension tensile jig (maintenance part):

Fix the belt tension tensile jig (for J1, J2, J3) to the Joint #1 motor plate.

Hexagon socket head cap bolts: M5×45

Use the belt tension tensile jig (for J1, J2, J3) as shown in the photo to apply a specified tension.

As the screw is tightened, the Joint #1 motor unit will be pulled and tension will be applied.

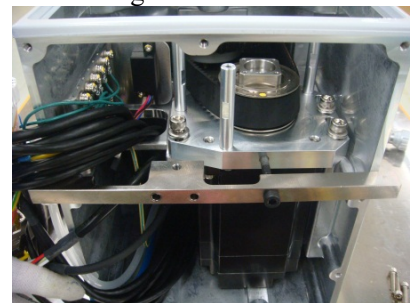

**C8-A1401\*\* (C8XL):**

Install the heat radiation block

For details, refer to the *Heat radiation block Installation*

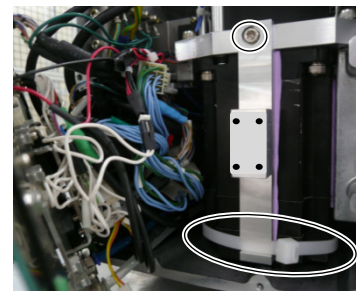



4. Install the Joint #1 electromagnetic brake / brake plate to the Joint 1 motor unit.

Hexagon socket head cap bolts: 3-M4×20

Tightening torque:  $4.0 \pm 0.2 \text{ N}\cdot\text{m}$

Check that the motor and the brake core are aligned.

Regarding brake misalignment:

- Misalignment of the brake core may cause abnormal sound or apply abnormal torque on the brake. It may result in breakdown of the brake.

When using the J1 brake positioning jig (maintenance part):

Using the J1 brake positioning jig, check that the motor and the brake core are aligned when fixing the brake.

If the J1 brake positioning jig cannot be inserted all the way, the motor and the brake core may be misaligned. In such a case, use the brake release unit (option part) to release the brake, and then align the brake.

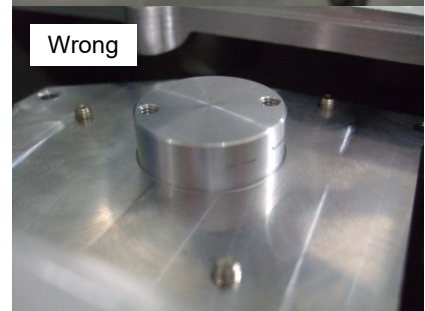
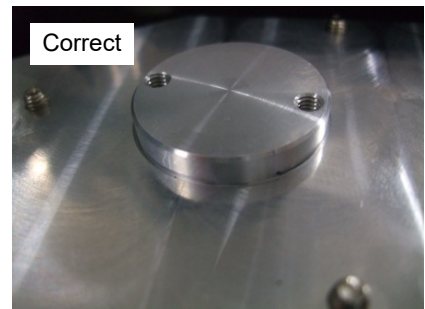

5. Install the brake power supply to the plate. Make sure to install the brake power supply so that the cables will be in the direction as shown in the photo.

Cross recessed head screws with washer: 2-M3×6

Tightening torque:  $0.45 \pm 0.1 \text{ N}\cdot\text{m}$

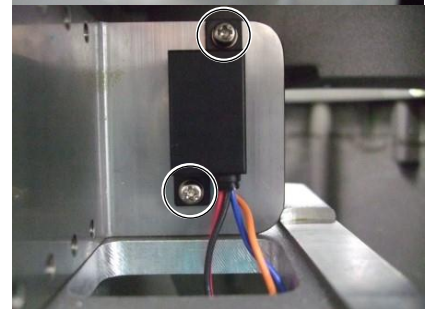

6. Connect the following connectors.  
Connectors: X11, X010, BT1, BR011
7. Mount the connector plate (M/C cable backward).  
For details, refer to *Maintenance: 3. Covers*.
8. Mount the base maintenance cover.  
For details, refer to *Maintenance: 3. Covers*.
9. Calibrate the Joint #1.  
For details, refer to *Maintenance: 16. Calibration*.



## Heat radiation block Installation

1. Check that the heat radiation sheet is attached on the heat radiation block.

**NOTE** If the Manipulator is operated without the heat radiation sheet, the motor generates heat and the error may occur.  
 If the heat radiation sheet has the protection film, remove the film.

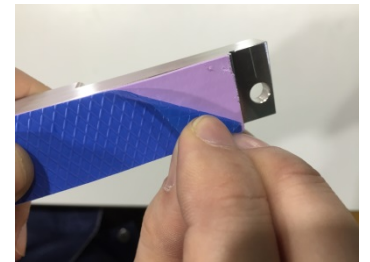
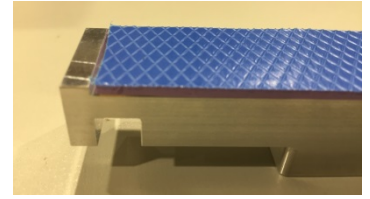

(Image of the protection film)

2. Fix the upper part of the heat radiation block to the Joint #1 motor plate with the bolts.

Hexagon socket head cap bolts: M5×15

Tightening torque:  $4.0 \pm 0.2$  N·m

3. Fix the lower part of the heat radiation block to the motor with the wire tie.

Wire tie: AB350

3-1 Insert the wire tie under the motor.

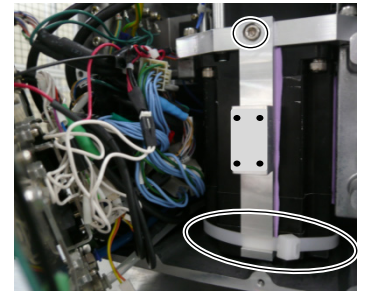

3-2 Hold the end of the wire tie.

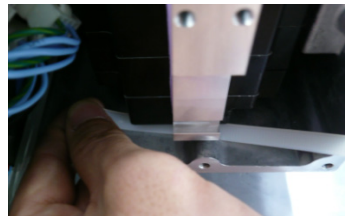

3-3 While holding the end of the wire tie, push the wire tie to the direction as indicated with the arrow in the photo.



3-4 Wrap the wire tie around the motor.

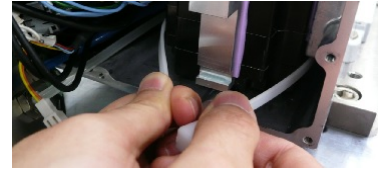

3-5 Tighten the wire tie to hold the heat radiation sheet firmly.

Make sure that the heat radiation sheet sticks out of the heat radiation block.

**NOTE**



Do not tighten the wire tie too much. It may result in cable breakage.

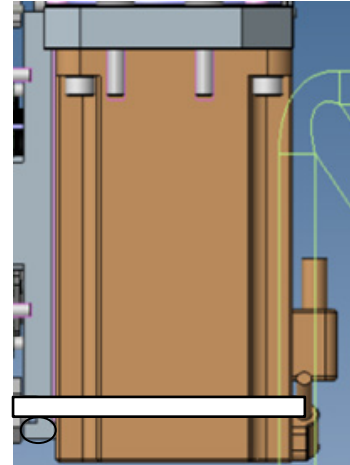

**5.1.2 Joint #1 - Replacing the Reduction Gear Unit  
(M/C Cable Backward)**

	Name		Qty.	Note
Maintenance Parts	Reduction gear unit (Joint #1)	C8-A701** (C8)	1	1674602
		C8-A901** (C8L)	1	1674603
		C8-A1401** (C8XL)	1	1674604
	Belt tensile jig*		1	1674582
	J1 brake positioning jig*		1	1675081
	Wire tie (AB100)		1	1675753
Tools	Hexagonal wrench	width across flats: 2.5 mm	1	For M3 hexagon socket head cap bolts
		width across flats: 3 mm	1	For M4 hexagon socket head cap bolts
		width across flats: 4 mm	1	For M5 hexagon socket head cap bolts
		width across flats: 5 mm	1	For M6 hexagon socket head cap bolts
	Cross-point screwdriver (#2)		1	For cross recessed head screws
	Torque wrench		1	For tightening torque control
	Belt tension meter		1	Refer: Unitta U-505
	Cloth (cushioning)		1	For pressing arms

\* The belt tensile jig and J1 brake positioning jig are assembly jigs. Use the jigs when adjusting belt tension.

The brake is mounted on each joint to prevent the arm from lowering due to its own weight while the Controller power is OFF or the motor is OFF status. The brake does not work during replacement. Be careful when performing maintenance work.

When removing the Joint #2 motor unit, tilt the Arm #2 and press it toward the Arm #1.

Reference: *Maintenance 6.1 Joint #2 - Replacing the Motor*; Removal step (2)

When pressing the arm, put a piece of cloth or a similar material between the arms to avoid contacting each other. This protects the arm surfaces from scratching and paint peeling off.

Removal: Joint #1 Reduction gear unit (M/C Cable Backward)

 CAUTION	<ul style="list-style-type: none"> <li>■ This procedure has possibility of hands and fingers being caught and/or damage or malfunction to the Manipulator. Be very careful when performing maintenance.</li> <li>■ Do not loosen the bolts while the Arm #2 is not tilted. It may cause the belt come off and the Arm #2 falls down, and it is extremely hazardous. Be sure to do the Removal steps (1) and (2) in <i>Maintenance 6.1 Joint #2 - Replacing the Motor</i> before removing the motor.</li> <li>■ When removing the Arm #1, there must be two or more people to work on it so that at least one of them can support the arm while the others are removing the bolts. Removing the bolts without supporting the arm may result in the arm falling, bodily injury, and/or malfunction of the robot system.</li> </ul>
--	--

1. Remove the following parts.

- Connector plate
- Connector
- Cable grounding plate
- Brake power supply

For details, refer to *Maintenance 5.1.3 Joint #1 - Replacing the Timing Belt (M/C Cable Backward)*, Removal steps (1) to (9).

2. Remove the ground terminals.

- Cross recessed head screws with washer
- S, C models : 9-M4×8, 2-M3×6
- P model : 10-M4×8, 2-M3×6

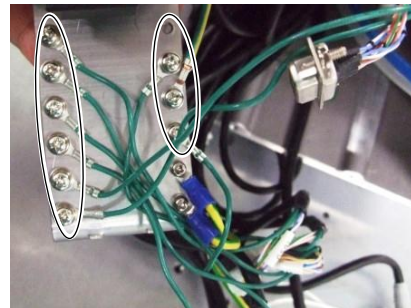

3. Disconnect the following parts from the hole inside the base.

- D-sub cable
- Ground wire
- RJ45 connector
- F-sensor connector



4. Remove the Joint #1 motor unit.

For details, refer to *Maintenance 5.1.1 Joint #1 – Replacing the Motor Unit (M/C Cable Backward)*, Removal steps (6) to (7).

5. Remove the cable interference prevention plate.

Hexagon socket head cap bolts: 2-M3×6

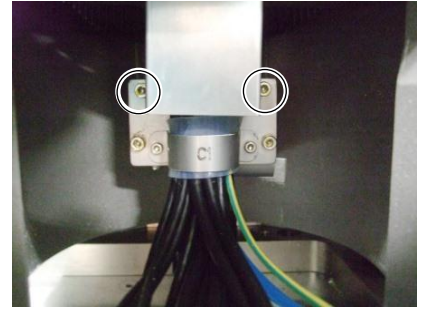

6. Remove the base cable bracket (C1).

Hexagon socket head cap bolts: 2-M3×6



7. Remove the Joint #1 timing belt.

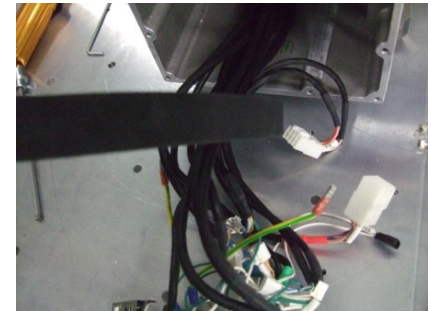

8. Remove the Joint #2 motor unit.

For details, refer to *Maintenance 6.1 Joint #2 - Replacing the Motor*, Removal steps (1) to (9).

9. Remove the Joint #1 cable fixing plate (Arm #1 side).

Hexagon socket head cap bolts: 2-M4×10



10. Remove the connector connected to the control board 1.

Connector: GS01

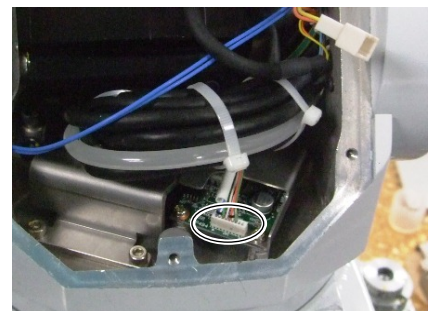

11. Disconnect the internal cables from the base to the Arm #1 side.  
Protect the connectors with masking tapes.

- To protect the connector's clips
- To avoid adherence of cable grease



**NOTE**  Disconnect the cables one by one in order from the smallest connector to the largest one.  
Do not attempt to pull all connectors at once.  
Doing so may damage the cables.

12. Pull out the grease tube (between the base and the Arm #1) on the Arm #1 side from the fitting.



13. Remove the Arm #1 from the base.

Hexagon socket head cap bolts: 15-M6×30 (with a plain washer)

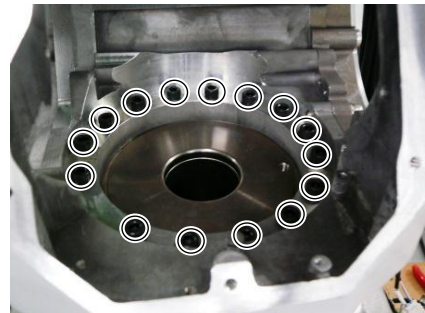

**CAUTION**

■ By removing the bolts, the Arm #1, #2, #3, #4, #5, and #6(end effector) can be separated. There is a possibility of hands and fingers being caught and/or damage or malfunction to the Manipulator. Be very careful when removing the arm. Have at least two workers so that one can support the Manipulator while the other worker is removing the bolts.

14. Remove the Joint #1 reduction gear unit.

Hexagon socket head cap bolts: 12-M6×50





## Installation: Joint #1 Reduction gear unit (M/C Cable Backward)

1. Install the Joint #1 reduction gear unit.

Hexagon socket head cap bolts: 12-M6×50

Tightening torque:  $18.0 \pm 0.9$  N·m

Installation face of the base reduction gear unit has clearance holes.

Install the reduction gear unit to match the screws and the clearance holes.



2. Install the Arm #1 to the base.

Hexagon socket head cap bolts: 15-M6×30 (with a plain washer)

Tightening torque:  $18.0 \pm 0.9$  N·m



CAUTION

- There is a possibility of hands and fingers being caught and/or damage or malfunction to the Manipulator. Be very careful when installing the arm. Have at least two workers so that one can support the Manipulator while the other worker is removing the bolts.

3. Connect the grease tube for the Arm #1 side to the fitting.



4. Pass the internal cables from the Arm #1 side to the base. Protect the connectors with masking tapes.

- To protect the connector's clips
- To avoid adherence of cable grease



NOTE Disconnect the cables one by one in order from the largest connector to the smallest one.

Do not attempt to pull all connectors at once.

Doing so may damage the cables.

5. Connect the connector to the control board 1.

Connector: GS01



6. Install the Joint #1 cable bracket (Arm #1 side).

Hexagon socket head cap bolts: 2-M4×10

Tightening torque:  $4.0 \pm 0.2$  N·m



7. Install the Joint #2 motor unit.

For details, refer to *Maintenance 6.1 Joint #2 - Replacing the Motor*, Installation steps (4) to (9).

8. Pass the cables and the air tube inside the Joint #1 timing belt.



9. Mount the base cable bracket (C1).

Wrap the cables with the attached silicone sheet.  
Use a cable bracket to fix the wrapped silicone sheet.

Hexagon socket head cap bolts: 2-M3×6

Tightening torque:  $2.0 \pm 0.1$  N·m



10. Install the cable interference prevention plate.

Hexagon socket head cap bolts: 2-M3×6

Tightening torque:  $2.0 \pm 0.1$  N·m

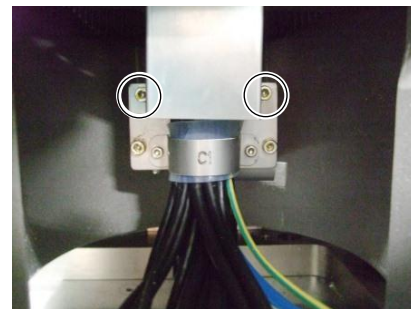



## 11. Install the Joint #1 motor unit.

For details, refer to *Maintenance 5.1.1 Joint #1 – Replacing the Motor (M/C Cable Backward)*, Removal steps (1) to (4).

## 12. Pass the following parts through the hole inside the base to the upper part of the base.

D-sub cable  
Ground wire  
RJ45 connector  
F-sensor connector



## 13. Connect the ground wires.

Cross recessed head screws with washer

S, C models : 9-M4×8, 2-M3×6

P model : 10-M4×8, 2-M3×6

Tightening torque :  $0.9 \pm 0.1 \text{ N}\cdot\text{m}$  (M4×8)  
 $0.45 \pm 0.1 \text{ N}\cdot\text{m}$  (M3×6)

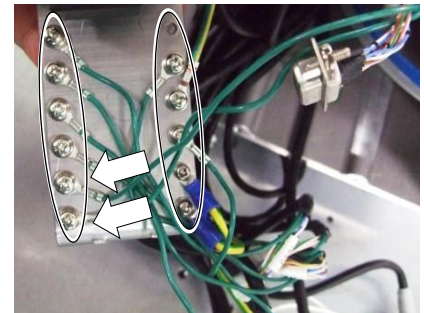

**NOTE**  The ground terminals of the D-sub cables have fixed installation positions. Install them to the two screw holes. (Photo: indicated by the arrows).

## 14. Install the following parts.

Connector plate

Connector

Cable grounding plate

Brake power supply

For details, refer to *Maintenance 5.1.3 Joint #1 – Replacing the Timing Belt (M/C Cable Backward)*, Installation steps (6) to (14).

## 5.1.3 Joint #1 - Replacing the Timing Belt (M/C Cable Backward)

	Name		Qty.	Note	
Maintenance Part	Timing belt (Joint #1)	C8-A701** (C8)	1	560 mm	1655928
		C8-A901** (C8L)	1	580 mm	1655929
		C8-A1401** (C8XL)	1	595 mm	1655930
	Belt tensile jig *		1	1674582	
	J1 brake positioning jig*		1	1675081	
	Wire tie AB100		1	1675753	
Tools	Hexagonal wrench	width across flats: 2.5 mm	1	For M3 hexagon socket head cap bolt	
		width across flats: 3 mm	1	For M4 hexagon socket head cap bolt	
		width across flats: 4 mm	1	For M5 hexagon socket head cap bolt	
		width across flats: 5 mm	1	For M6 hexagon socket head cap bolt	
	Box wrench	width across flats: 5 mm	1	For D-Sub connector	
	Long nose pliers		1	For removing the air tube	
	Cross-point screwdriver		1	For cross recessed head screws	
	Torque wrench		1	For tightening torque control	
Belt tension meter		1	Refer: Unitta U-505		

\* The belt tensile jig and J1 brake positioning jig are assembly jigs. Use these jigs in relevant maintenance steps.

The brake is mounted on each joint to prevent the arm from lowering due to its own weight while the Controller power is OFF or the motor is OFF status. The brake does not work during replacement. Be careful when performing maintenance work.

### Removal: Joint #1 Timing belt (M/C Cable Backward)

1. Turn OFF the Controller.
2. Remove the base maintenance cover.  
For details, refer to *Maintenance 3. Covers*.
3. Remove the connector plate (M/C cable backward).  
For details, refer to *Maintenance 3. Covers*.
4. Remove two air tubes inside the base.
5. Remove two D-sub connectors.
6. Disconnect the cables from the base and disconnect the connectors.

Connector: X11, X12, X14, BR010, BR011, X010, X020,  
X040, LED, GS01, BT1  
(Hold the clip to remove.)



7. Disconnect the following connectors.

RJ45 connector:

Hold the clip to remove.



F-sensor connector:

Open the clips on the both ends of the connector and pull it out.

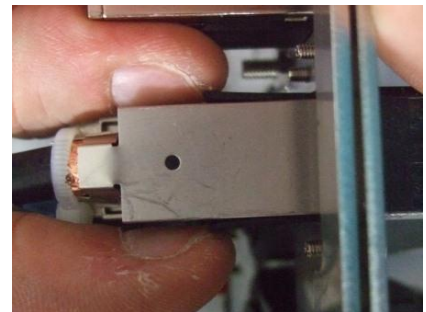

Remove the ground wire from each connector.  
To remove the ground wire, hold the connector by hand and pull the ground wire.

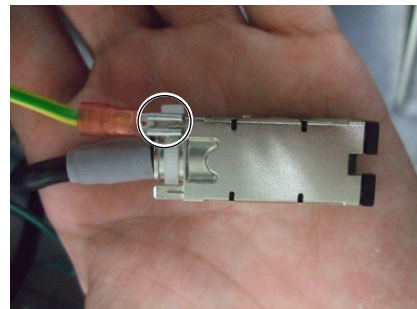

- 8. Remove the brake power supply.  
Cross recessed head screws with washer: 2-M3×6

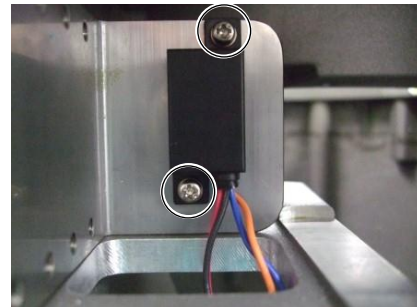

- 9. Remove the ground wire plate (M/C cable backward).  
Hexagon socket head cap bolts: 2-M4×10

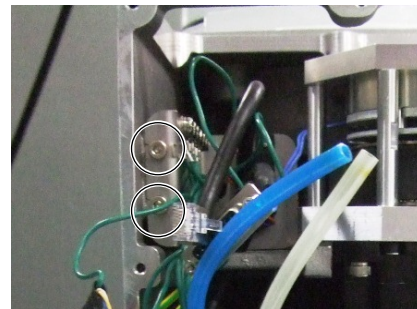

- 10. Remove the following ground wire terminals.  
D-sub cable ground wire terminals (×2)  
Ground wire (green/yellow) terminal (×1) indicated by an arrow  
Cross recessed head screws with washer: 3-M4×8

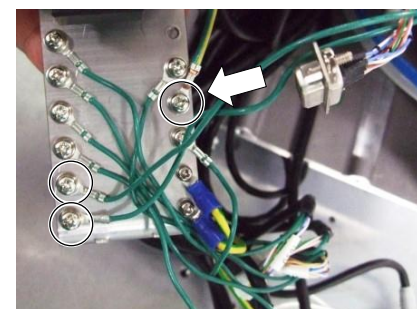

**NOTE**  Positions of the ground wire (green/yellow) terminals may differ from the photo. Check the positions of the terminals before removing them.

11. Disconnect the following parts downward from the hole inside the base.

- D-sub cable
- Ground wire
- RJ45 connector
- F-sensor connector



12. Remove the Joint #1 motor unit.

For details, refer to *Maintenance: 5.1.1 Joint #1-Replacing the Motor (M/C Cable Backward)*, Removal steps (6) to (7).

13. Remove the Joint #1 cable fixing plate.

- Hexagon socket head cap bolts: 2-M3×6

Do not remove the base cable bracket (C1)



14. Remove the Joint #1 timing belt.





Installation: Joint #1 Timing belt (M/C Cable Downward)

1. Pass the cables and air tubes to the Joint #1 timing belt.

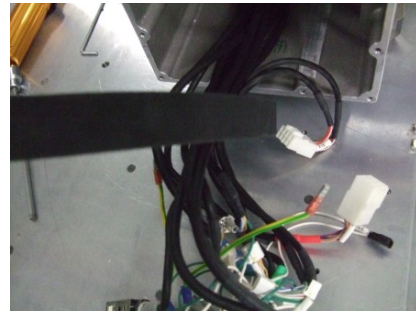

2. Mount the Joint #1 cable fixing plate.

Hexagon socket head cap bolts: 2-M3×6

Tightening torque:  $2.0 \pm 0.1$  N·m



3. Mount the Joint #1 motor unit.

For details, refer to *Maintenance: 5.1.1 Joint #1-Replacing the Motor (M/C Cable Backward)*, Installation steps (1) to (4).

4. Disconnect the following parts from the hole inside the base to the upper side of the base.

- D-sub cable
- Ground wire
- RJ45 connector
- F-sensor connector



5. Install the terminals of the D-sub cable ground wire and ground wire (green/yellow).

D-sub cable ground wire terminals (×2) indicated by arrows

Ground wire (green/yellow) terminal (×1)

Cross recessed head screws with washer: 3-M4×8

Tightening torque:  $0.9 \pm 0.1$  N·m

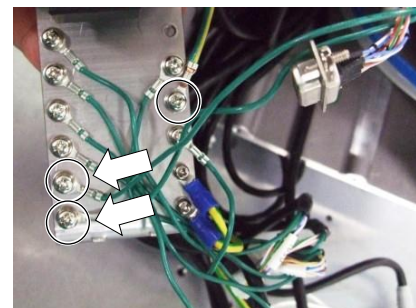

**NOTE**  The installation positions of the D-sub cable ground terminals are fixed. Make sure to install them to the two screw holes on the backside of the Manipulator (as indicated by arrows in the photo).

6. Mount the ground wire plate (M/C cable backward).

Hexagon socket head cap bolts: 2-M4×10

Tightening torque:  $4.0 \pm 0.2$  N·m

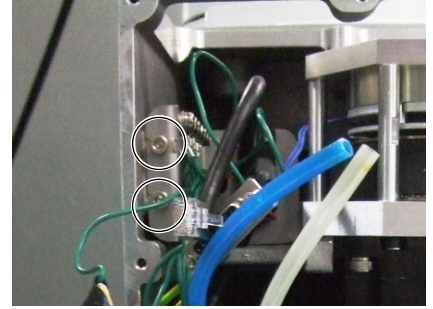

7. Install the brake power supply to the plate. Make sure to install the brake power supply so that the cables will be in the direction as shown in the photo.

Cross recessed head screws with washer: 2-M3×6

Tightening torque:  $0.45 \pm 0.1$  N·m

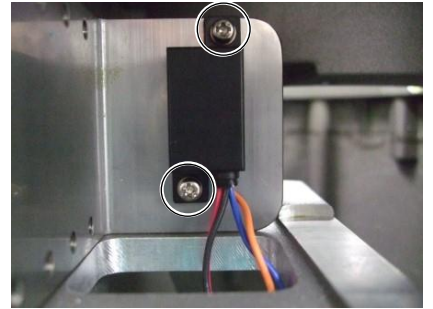

8. Install the following connectors in accordance with the indications on the connector plates.

RJ45 connector: Ether

F-sensor connector: F-sensor

Install the ground wire to each connector. To connect the ground wire, insert it while holding the connector by hand.

9. Connect the M/C cable connectors.

Connector: X11, X12, X14, BR010, BR011, X010, X020, X040, LED, GS01, BT1

10. Install the D-sub connectors in accordance with the indications on the connector plates.

Left: D-sub for brake release (with a wire marker: SW1) : B-release

Right: D-sub for user wiring (no wire marker: with a round terminal): D-sub



11. Install two air tubes in accordance with the indications on the connector plates.

Air1: Semitransparent

Air2: Blue

NOTE



Be careful not to install the air tube of wrong color.

12. Install the connector plate (M/C cable backward).

For details, refer to *Maintenance: 3 Covers*.

13. Install the base maintenance cover.

For details, refer to *Maintenance: 3 Covers*.

14. Calibrate the Joint #1.

For details, refer to *Maintenance: 16. Calibration*.



**5.1.4 Joint #1 - Replacing the Electromagnetic Brake  
(M/C Cable Backward)**

	Name	Qty.	Note
<b>Maintenance Parts</b>	Electromagnetic brake (Joint #1, 2)	1	2172926
	J1 brake positioning jig *	1	1675081
	Wire tie (AB100)	1	1675753
<b>Tools</b>	Hexagonal wrench (width across flats: 3 mm)	1	For M4 hexagon socket head cap bolt
	Cross-point screwdriver (#2)	1	For cross recessed head screws
	Torque wrench	1	For tightening torque control

\* The belt tensile jig and J1 brake positioning jig are assembly jigs. Use these jigs in relevant maintenance steps.

The brake is mounted on each joint to prevent the arm from lowering due to its own weight while the Controller power is OFF or the motor is OFF status. The brake does not work during replacement. Be careful when performing maintenance work.

Removal: Joint #1 Electromagnetic brake (M/C Cable Backward)

1. Remove the Joint #1 electromagnetic brake from the Joint #1 motor unit.  
For details, refer to *Maintenance: 5.1.1 Joint #1-Replacing the Motor (M/C Cable Backward)*, Removal steps (1) to (6).

NOTE

 Do not disconnect the connector BT1. If the connector is disconnected, perform calibration.

2. Remove the Joint #1 brake from the brake plate.

Hexagon socket head cap bolts: 3-M4×25

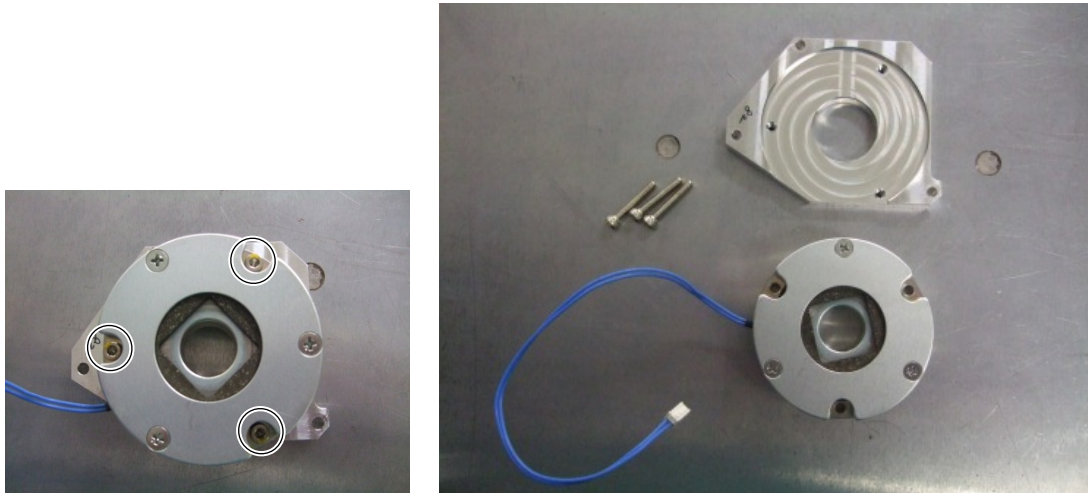

Installation: Joint #1 Electromagnetic brake (M/C Cable Backward)

1. Install the Joint #1 brake to the brake plate.

Hexagon socket head cap bolts: 3-M4×25

Tightening torque:  $4.0 \pm 0.2 \text{ N}\cdot\text{m}$

Be careful of the assembly direction of the Joint #1 electromagnetic brake. (See the photo)



2. Mount the Joint #1 brake plate to the Joint #1 motor unit.

For details, refer to *Maintenance: 5.1.1 Joint #1-Replacing the Motor (M/C Cable Backward)*, Installation steps (4) to (8).

NOTE

 If you disconnected the connector BT1 in the removal steps, perform calibration.

## 5.2 M/C Cable Downward (Joint #1)

### 5.2.1 Joint #1 - Replacing the Motor (M/C Cable Downward)

	Name		Qty.	Note
Maintenance Parts	Motor unit (Joint #1)	C8-A701*B* (C8)	1	2172921
		C8-A901*B* (C8L)		
		C8-A1401*B* (C8XL)		
		Belt tensile jig*	1	1674582
		J1 brake positioning jig*	1	1675081
		Wire tie	AB100	1
	AB350		1	1697428
Tools	Hexagonal wrench	width across flats: 3 mm	1	For M4 hexagon socket head cap bolts
		width across flats: 4 mm	1	For M5 hexagon socket head cap bolts
		width across flats: 5 mm	1	For M6 hexagon socket head cap bolts
		Cross-point screwdriver (#2)	1	For cross recessed head screws
		Torque wrench	1	For tightening torque control
		Nippers	1	For cutting the wire tie
		Pliers	1	For tightening the wire tie
		Belt tension meter	1	Refer: Unitta U-505

\* The belt tensile jig and J1 brake positioning jig are assembly jigs. Use these jigs in relevant maintenance steps.

The brake is mounted on each joint to prevent the arm from lowering due to its own weight while the Controller power is OFF or the motor is OFF status. The brake does not work during replacement. Be careful when performing maintenance work.

Removal: Joint #1 Motor (M/C Cable Downward)

1. Turn OFF the Controller.
2. Turn the Manipulator laterally.

 <b>CAUTION</b>	<p>■ When turning the Manipulator laterally, there must be two or more people to work on it so that at least one of them can support the arm while the others are removing the bolts. Removing the bolts without supporting the arm may result in the arm falling, bodily injury, and/or malfunction of the robot system.</p>
---	---

3. Remove the following covers.
  - Base maintenance cover
  - Base cover (M/C cable downward)
  - Connector plate (M/C cable downward)

For details, refer to *Maintenance: 3 Covers*.

4. Disconnect the cables from the base and disconnect the following connectors.
  - Connector: X11, X010, BT1, BR011
  - (Hold the clip to remove.)

**NOTE** When only replacing the brake, do not disconnect the connector BT1. If the connector is disconnected, perform calibration.



C8-A701\*\* (C8) C8-A901\*\* (C8L)

C8-A1401\*\* (C8XL):  
Remove the heat radiation block.

1. Remove the wire tie and the bolts to remove the heat radiation block.
  - Hexagon socket head cap bolts: M5×15
  - Wire tie: AB350
2. Remove the heat radiation sheet between the heat radiation block and the motor.

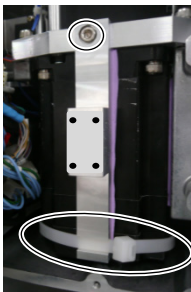

C8-A1401\*B\* (C8XL)

**NOTE** The heat radiation block, the heat radiation sheet, and the bolts will be used again. Be careful not to lose them.  
Be careful not to tear the heat radiation sheet.

5. Remove the brake power supply.
  - Cross recessed head screws with washer: 2-M3×6

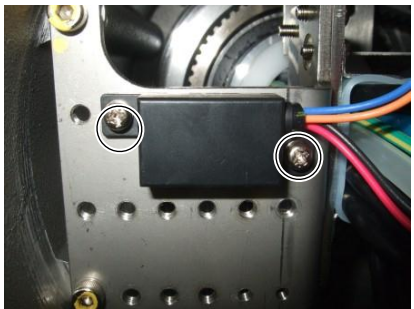

6. Remove the Joint #1 brake plate from the Joint #1 motor unit.

Hexagon socket head cap bolts: 3-M4×20

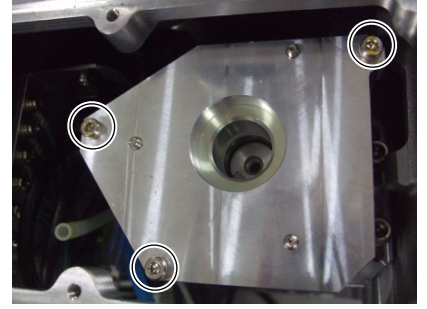

7. Remove the Joint #1 motor unit from the base.

Hexagon socket head cap bolts: 3-M6×30 (with a plain washer)

Be careful not to tear and lose the heat radiation sheet attached to the motor.

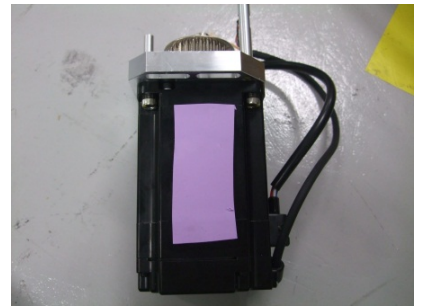

Installation: Joint #1 Motor (M/C Cable Downward)

1. Mount the Joint #1 motor unit to the base.

For details, refer to *Maintenance: 5.1.1 Joint #1-Replacing the Motor (M/C Cable Backward)*, Removal steps (1) to (4).

2. Install the brake power supply to the plate. Make sure to install the brake power supply so that the cables will be in the direction as shown in the photo.

Cross recessed head screws with washer: 2-M3×6

Tightening torque:  $0.45 \pm 0.1$  N·m

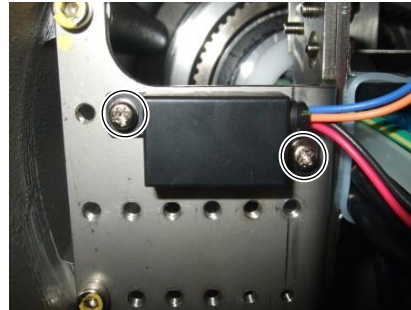

3. Connect the following connectors.

Connector: X11, X010, BT1, BR011

4. Install the following covers.

Connector plate (M/C cable downward).

Base cover (M/C cable downward)

Base maintenance cover

For details, refer to *Maintenance: 3 Covers*.

5. Calibrate the Joint #1.

For details, refer to *Maintenance: 16. Calibration*.

**5.2.2 Joint #1 - Replacing the Reduction Gear Unit  
(M/C Cable Downward)**

	Name		Qty.	Note
Maintenance Parts	Reduction gear unit (Joint #1)	C8-A701*B* (C8)	1	1674602
		C8-A901*B* (C8L)	1	1674603
		C8-A1401*B* (C8XL)	1	1674604
	Belt tensile jig*		1	1674582
	J1 brake positioning jig*		1	1675081
	Wire tie AB100		1	1675753
Tools	Hexagonal wrench	width across flats: 2.5 mm	1	For M3 hexagon socket head cap bolts
		width across flats: 3 mm	1	For M4 hexagon socket head cap bolts
		width across flats: 4 mm	1	For M5 hexagon socket head cap bolts
		width across flats: 5 mm	1	For M6 hexagon socket head cap bolts
	Cross-point screwdriver (#2)		1	For cross recessed head screws
	Torque wrench		1	For tightening torque control
	Belt tension meter		1	Refer: Unitta U-505
	Cloth (cushioning)		1	For pressing arms

\* The belt tensile jig and J1 brake positioning jig are assembly jigs. Use the jigs when adjusting belt tension.

The brake is mounted on each joint to prevent the arm from lowering due to its own weight while the Controller power is OFF or the motor is OFF status. The brake does not work during replacement. Be careful when performing maintenance work.

When removing the Joint #2 motor unit, tilt the Arm #2 and press it toward the Arm #1.

Reference: *Maintenance 6.1 Joint #2 - Replacing the Motor*; Removal step (2)

When pressing the arm, put a piece of cloth or a similar material between the arms to avoid contacting each other. This protects the arm surfaces from scratching and paint peeling off.

Removal: Joint #1 Reduction gear unit (M/C cable downward)

 <p>CAUTION</p>	<ul style="list-style-type: none"><li>■ This procedure has possibility of hands and fingers being caught and/or damage or malfunction to the Manipulator. Be very careful when performing maintenance.</li><li>■ Do not loosen the bolts while the Arm #2 is not tilted. It may cause the belt come off and the Arm #2 falls down, and it is extremely hazardous. Be sure to do the Removal steps (1) and (2) in <i>Maintenance 6.1 Joint #2 - Replacing the Motor</i> before removing the motor.</li><li>■ When removing the Arm #1, there must be two or more people to work on it so that at least one of them can support the arm while the others are removing the bolts. Removing the bolts without supporting the arm may result in the arm falling, bodily injury, and/or malfunction of the robot system.</li></ul>
--	--

1. Remove the following parts.

Connector plate  
Connector  
Brake power supply

For details, refer to *Maintenance 5.2.3 Joint #1 - Replacing the Timing Belt (M/C Cable Downward)*, Removal steps (1) to (8).

2. Remove the ground terminals.

Cross recessed head screws with washer  
S, C models : 9-M4×8, 2-M3×6  
P model : 10-M4×8, 2-M3×6

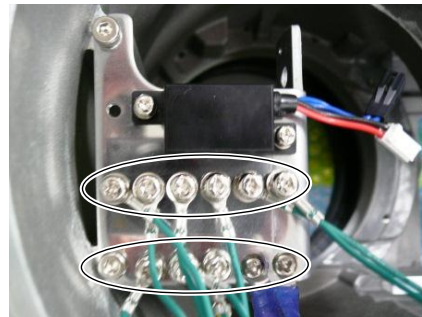

3. Remove the Joint #1 reduction gear unit.

For details, refer to *Maintenance 5.1.2 Joint #1 - Replacing the Reduction Gear Unit (M/C Cable Backward)*, Removal steps (4) to (14).



**Installation: Joint #1 Reduction gear unit (M/C Cable Downward)**

1. Install the Joint #1 reduction gear unit.

For details, refer to *Maintenance 5.1.2 Joint #1- Replacing the Reduction Gear Unit (M/C Cable Backward)*, Installation steps (1) to (11).

2. Install the ground terminals to the plate.

Cross recessed head screws with washer

S, C models : 9-M4×8, 2-M3×6

P model : 10-M4×8, 2-M3×6

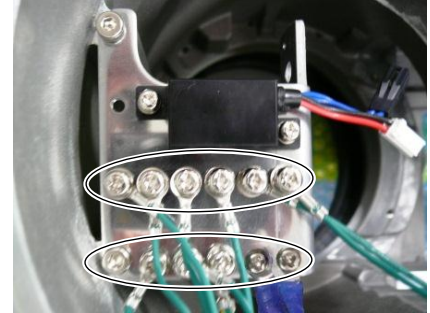

3. Install the following parts.

Connector plate

Connector

Brake power supply

For details, refer to *Maintenance 5.2.3 Joint #1 - Replacing the Timing Belt (M/C Cable Downward)*, Installation steps (4) to (10).

5.2.3 Joint #1 - Replacing the Timing Belt (M/C Cable Downward)

	Name		Qty.	Note	
Maintenance Part	Timing belt (Joint #1)	C8-A701*B* (C8)	1	560 mm	1655928
		C8-A901*B* (C8L)	1	580 mm	1655929
		C8-A1401*B* (C8XL)	1	595 mm	1655930
	Belt tensile jig*		1	1674582	
	J1 brake positioning jig*		1	1675081	
	Wire tie AB100		1	1675753	
Tools	Hexagonal wrench	width across flats: 3 mm	1	For M4 hexagon socket head cap bolt	
		width across flats: 4 mm	1	For M5 hexagon socket head cap bolt	
		width across flats: 5 mm	1	For M6 hexagon socket head cap bolt	
	Box wrench	width across flats: 5 mm	1	For D-Sub connector	
	Long nose pliers		1	For removing the air tube	
	Cross-point screwdriver		1	For cross recessed head screws	
	Torque wrench		1	For tightening torque control	
	Belt tension meter		1	Refer: Unitta U-505	

\* The belt tensile jig and J1 brake positioning jig are assembly jigs. Use these jigs in relevant maintenance steps.

The brake is mounted on each joint to prevent the arm from lowering due to its own weight while the Controller power is OFF or the motor is OFF status. The brake does not work during replacement.

Be careful when performing maintenance work.

## Removal: Joint #1 Timing belt (M/C Cable Downward)

1. Turn OFF the Controller.
2. Turn the Manipulator laterally.



- When turning the Manipulator laterally, there must be two or more people to work on it so that at least one of them can support the arm while the others are removing the bolts. Removing the bolts without supporting the arm may result in the arm falling, bodily injury, and/or malfunction of the robot system.

3. Remove the following covers.

Base maintenance cover  
 Base cover (M/C cable downward)  
 Connector plate (M/C cable downward)

For details, refer to *Maintenance: 3 Covers*.

4. Disconnect the cables from the base and disconnect the following connectors.

Connector: X11, X12, X14, BR010, BR011, X010, X020, X040,

LED, GS01, BT1  
 (Hold the clip to remove.)



5. Disconnect the following parts.

Air tubes  
 RJ45 connector  
 F-sensor connector  
 D-sub connector

For details, refer to *Maintenance: 5.1.3 Joint #1-Replacing the Timing Belt (M/C Cable Backward)*, Removal steps (4) to (5), and (7).

6. Remove the brake power supply.

Cross recessed head screws with washer: 2-M3×6

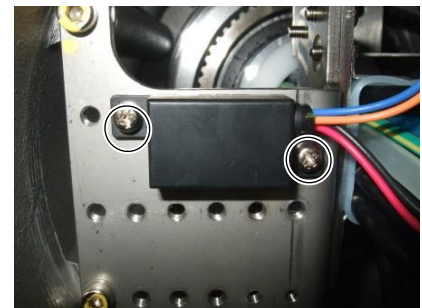

7. Remove the ground wire plate (M/C cable downward).

Hexagon socket head cap bolts: 2-M4×12

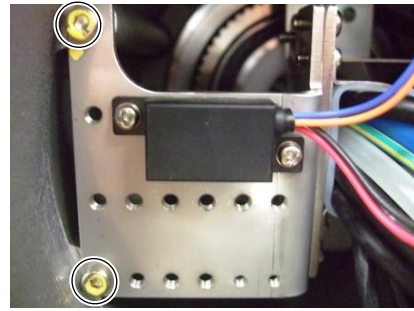

8. Remove the Joint #1 motor unit.

For details, refer to *Maintenance: 5.1.1 Joint #1-Replacing the Motor (M/C cable backward)*, Removal steps (6) to (7).

9. Remove the Joint #1 motor unit.



### Installation: Joint #1 Timing belt (M/C Cable Downward)

1. Pass the cables and the air tubes to the Joint #1 timing belt.



2. Mount the Joint #1 motor unit.

For details, refer to *Maintenance: 5.1.1 Joint #1-Replacing the Motor (M/C Cable Backward)*, Installation steps (1) to (4).

3. Mount the ground wire plate (M/C cable downward).

Hexagon socket head cap bolts: 2-M4×12

Tightening torque:  $4.0 \pm 0.2$  N·m

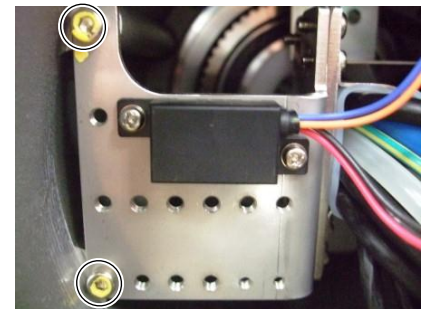

4. Install the brake power supply to the plate. Make sure to install the brake power supply so that the cables will be in the direction as shown in the photo.

Cross recessed head screws with washer: 2-M3×6

Tightening torque:  $0.45 \pm 0.1$  N·m

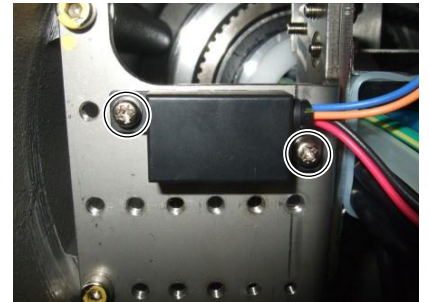

5. Connect the following connectors in accordance with the indications on the connector plates.

RJ45 connector: Ether

F-sensor connector: F-sensor

Install the ground wire to each connector. To connect the ground wire, insert in while holding the connector by hand.

6. Connect the M/C cable connectors.

Connector: X11, X12, X14, BR010, BR011, X010, X020, X040, LED, GS01, BT1

7. Install the D-sub connector in accordance with the indications on the connector plates.

Left: D-sub for brake release (with a wire marker: SW1): B-release

Right: D-sub for user wiring (no wire marker: with a round terminal): D-sub

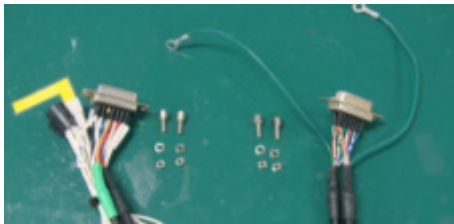

8. Install two air tubes in accordance with the indications on the connector plates.

Air1: Semitransparent

Air2: Blue

NOTE

 Be careful not to install the air tube of wrong color.

9. Install the following covers.

Connector plate (M/C cable downward)

Base cover (M/C cable downward)

Base maintenance cover

For details, refer to *Maintenance: 3 Covers*.

10. Calibrate the Joint #1.

For details, refer to *Maintenance: 16. Calibration*.

### 5.2.4 Joint #1 - Replacing the Electromagnetic Brake (M/C Cable Downward)

	Name	Qty.	Note
Maintenance Parts	Electromagnetic brake (Joint #1, #2)	1	2172926
	J1 brake positioning jig *	1	1675081
	Wire tie AB100	1	1675753
Tools	Hexagonal wrench (width across flats: 3 mm)	1	For M4 hexagon socket head cap bolt
	Cross-point screwdriver (#2)	1	For cross recessed head screws
	Torque wrench	1	For tightening torque control

\* The J1 brake positioning jig is an assembly jig. Use the jig in relevant maintenance steps.

The brake is mounted on each joint to prevent the arm from lowering due to its own weight while the Controller power is OFF or the motor is OFF status. The brake does not work during replacement. Be careful when performing maintenance work.

Removal: Joint #1 Electromagnetic brake (M/C Cable Downward)

1. Remove the Joint #1 brake plate from the Joint #1 motor unit.  
For details, refer to *Maintenance: 5.2.1 Joint #1-Replacing the Motor (M/C Cable Downward)*, Removal steps (1) to (6).

NOTE

 Do not disconnect the connector BT1. If the connector is disconnected, perform calibration.

2. Remove the Joint #1 brake from the brake plate.

Hexagon socket head cap bolts: 3-M4×25

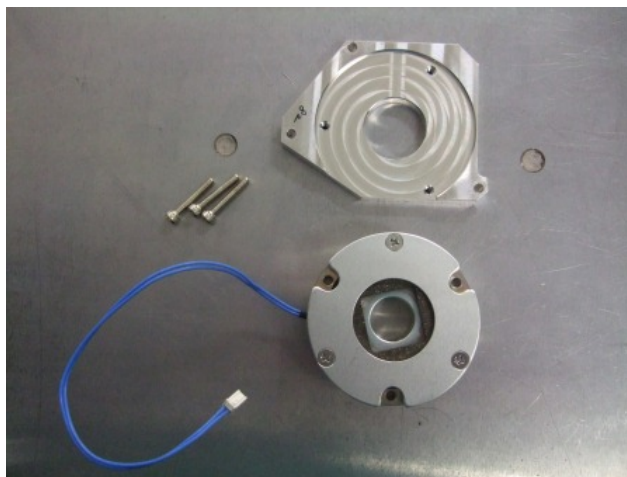



## Installation: Joint #1 Electromagnetic brake (M/C Cable Downward)

1. Install the Joint #1 brake to the brake plate.

Hexagon socket head cap bolts: 3-M4×25

Tightening torque:  $4.0 \pm 0.2$  N·m

Be careful of the assembly direction of the Joint #1 electromagnetic brake. (See the photo)

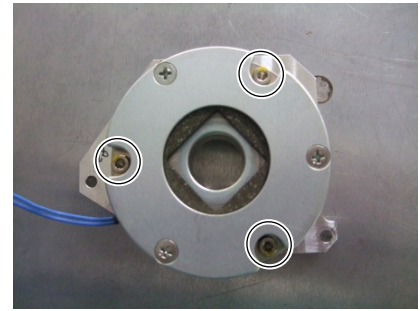

2. Mount the Joint #1 brake plate to the Joint #1 motor unit.

For details, refer to *Maintenance: 5.1.1 Joint #1 - Replacing the Motor (M/C Cable Backward)*, Installation step (4).

3. Install the brake power supply to the plate. Make sure to install the brake power supply so that the cables will be in the direction as shown in the photo.

Cross recessed head screws with washer: 2-M3×6

Tightening torque:  $0.45 \pm 0.1$  N·m

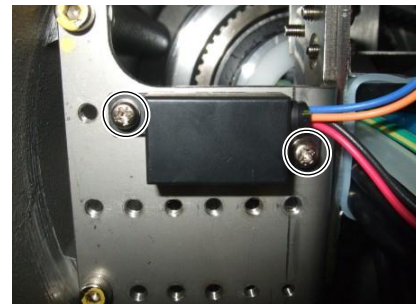

4. Connect the M/C cable connectors.  
Connector: X11, X010, BT1, BR011
5. Install the following covers.

Connector plate (M/C cable downward)

Base cover (M/C cable downward)

Base maintenance cover

For details, refer to *Maintenance: 3 Covers*.

## NOTE

 If you disconnected the connector BT1 in the removal steps, perform calibration.

## 6. Joint #2

 WARNING	<ul style="list-style-type: none"> <li>■ Do not connect or disconnect the motor connectors while the power to the robot system is turned ON. Connecting or disconnecting the motor connectors with the power ON is extremely hazardous and may result in serious bodily injury as the Manipulator may move abnormally, and also may result in electric shock and/or malfunction of the robot system.</li> <li>■ To shut off power to the robot system, disconnect the power plug from the power source. Be sure to connect the AC power cable to a power receptacle. DO NOT connect it directly to a factory power source.</li> <li>■ Before performing any replacement procedure, turn OFF the Controller and related equipment, and then disconnect the power plug from the power source. Performing any replacement procedure with the power ON is extremely hazardous and may result in electric shock and/or malfunction of the robot system.</li> </ul>
--	---

 CAUTION	<ul style="list-style-type: none"> <li>■ Be careful not to apply excessive shock to the motor shaft during replacement. It may shorten the life of the motors and encoder and/or damage them.</li> <li>■ Never disassemble the motor and the encoder. Disassembled motor and encoder will cause a positional gap and cannot be used again.</li> </ul>
--	---

After parts have been replaced (motors, reduction gear units, timing belts, etc.), the Manipulator cannot perform positioning properly because a gap exists between the origin stored in each motor encoder and its corresponding origin stored in the Controller. Therefore, it is necessary to match these origins after replacing the parts. The process of aligning the two origins is called “Calibration”. Refer to *Maintenance 16. Calibration* and perform the calibration after the parts replacement.

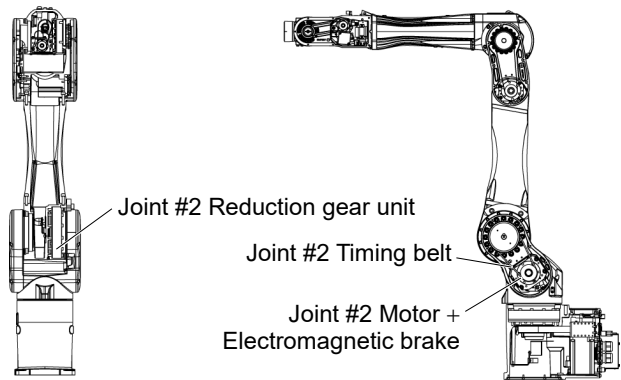

(Figure: C8-A1401\* (C8XL))

## 6.1 Joint #2 - Replacing the Motor

	Name	Qty.	Note	
Maintenance Parts	AC servo motor 750 W	1	2168683	
	Belt tensile jig*	1	1674582	
Tools	Hexagonal wrench	width across flats: 2.5 mm	1	For M5 hexagon socket set screw
		width across flats: 3 mm	1	For M6 hexagon socket head cap bolt
		width across flats: 4 mm	1	For M5 hexagon socket head cap bolt
		width across flats: 5 mm	1	For M6 hexagon socket head cap bolt
	Cross-point screwdriver (#2)	1	For cross recessed head screws	
	Torque wrench	1	For tightening torque control	
	Thickness gauge (0.5 mm)	2	For pulley position adjustment	
	Belt tension meter	1	Refer: Unitta U-505	
	Cloth (cushioning)	1	For pressing arms	

\* The belt tensile jig is an assembly jig. Use the jig when adjusting belt tension.

The brake is mounted on each joint to prevent the arm from lowering due to its own weight while the Controller power is OFF or the motor is OFF status. The brake does not work during replacement. Be careful when performing maintenance work.

When removing the Joint #2 motor, tilt the Arm #2 and press it against the Arm #1.

Reference: *Maintenance: 6.1 Joint #2 - Replacing the Motor*, Removal step (2)

When pressing the arm, put a piece of cloth or a similar material between the arms to avoid contacting each other. This protects the arm surfaces from scratching and paint peeling off.

Removal: Joint #2 Motor

 <p>CAUTION</p>	<ul style="list-style-type: none"><li>■ This procedure has possibility of hands and fingers being caught and/or damage or malfunction to the Manipulator. Be very careful when performing maintenance.</li><li>■ Do not loosen the bolts while the Arm #2 is not tilted.</li></ul> <p>It may cause the belt come off and the Arm #2 falls down, and it is extremely hazardous. Be sure to do the Removal steps 1 and 2 before removing the motor.</p>
--	---

1. Turn ON the Controller power.
2. Release the Joint #2 brake. Tilt the Arm #2 and push it against the Arm #1.

The Arm #2 falls by its own weight when the Joint #2 motor unit is removed. Therefore, release the brake and tilt the Arm #2 in advance.  
Put a cloth between the Arm #1 and Arm #2 so that the arms do not touch each other.

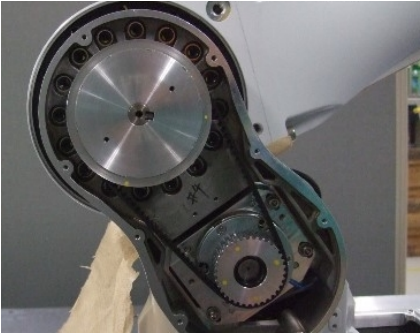

Command:  
>brake off, 2

 <p>CAUTION</p>	<ul style="list-style-type: none"><li>■ There is a possibility of hands and fingers being caught and/or damage or malfunction to the Manipulator. Be very careful when moving the Manipulator.</li></ul>
--	--

3. Turn OFF the Controller power.
4. Remove the Arm #1 center cover and the Arm #1 side cover.  
For details, refer to *Maintenance: 3. Covers*.

5. Remove the heat dissipation block and the heat dissipation sheet from the Arm #1.  
Hexagon socket head cap bolts: 2-M4×10

The heat dissipation sheet attached to the motor unit will be used again. Be careful not to tear and lose it.



6. Disconnect the following connectors of the motor.

Connector: X121, X021, BT2, BR021

(Hold the clip to remove.)



7. Remove the brake power supply.

Cross recessed head screws with captive washer: 2-M3×6

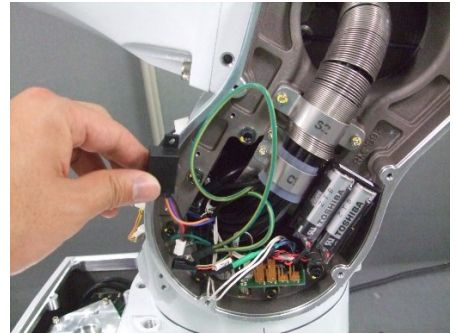

8. Loosen the bolts securing the Joint #2 motor unit and remove the belt.

Hexagon socket head cap bolts: 3-M5×25  
(with a plain washer)

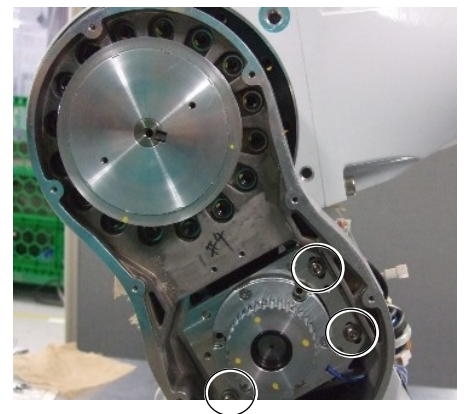

WARNING

- Loosening the bolts while the Arm #2 is not bent may cause the belt come off and the Arm #2 falls down, and it is extremely hazardous. Be sure to do the Removal steps 1 and 2 before loosening the bolts.

9. Remove the Joint #2 motor unit.

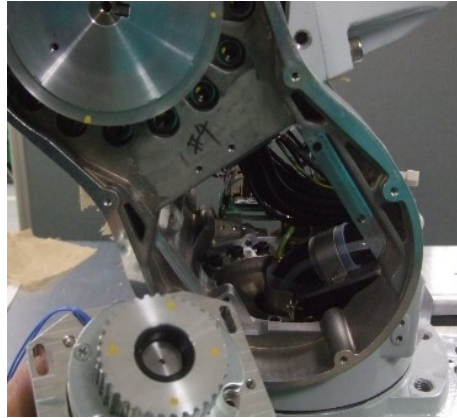

10. Remove the Joint #2 pulley 1 and the drive boss from the motor shaft of the Joint #2 motor unit.  
Remove two screws at the flat (D-cut) part of the motor shaft when viewing from above. (A in the figure)

Pulley and the motor shaft (A)  
Hexagon socket set screws: 2-M5×12

NOTE  Do not remove the pulley and drive boss screws (B in the figure). There is a brass bushing on one of the set screws. If you removed the screws (B), be careful not to lose the brass bushing.

- A: Pulley and motor shaft screws  
(D-cut part of the motor shaft × 2)
- B: Pulley and drive boss screws  
Do not remove these screws.
- C: Bushing

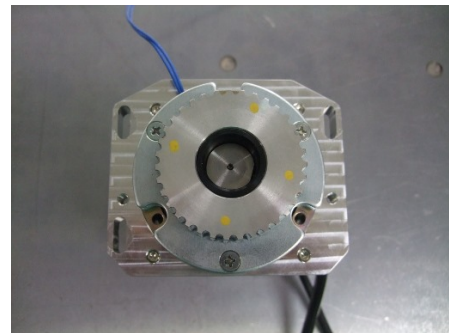
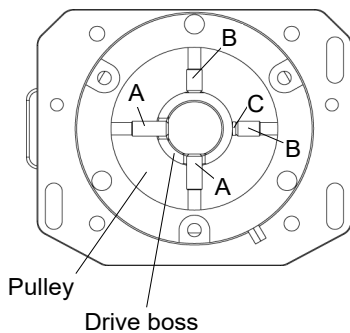

11. Remove the Joint #2 electromagnetic brake.  
Hexagon socket set screws: 2-M6×6 (with a brass bushing)

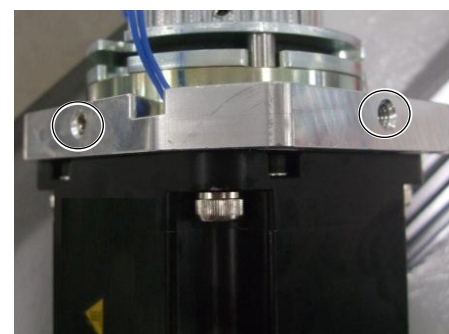



12. Remove the motor plate from the Joint #2 motor.

Hexagon socket head cap bolts: 4-M6×20

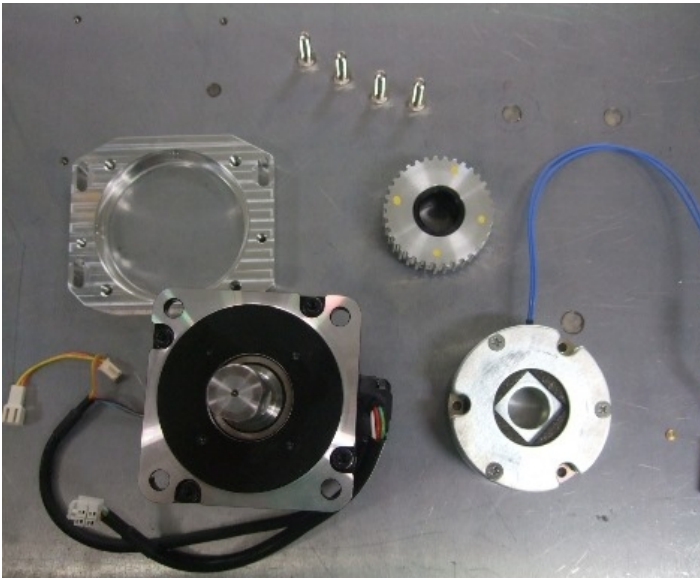

Installation: Joint #2 Motor

1. Install the motor plate to the Joint #2 motor.

Hexagon socket head cap bolts: 4-M6×20

Tightening torque:  $13.0 \pm 0.6 \text{ N}\cdot\text{m}$

NOTE  Be careful of the assembly direction of the motor plate.  
(See the photo.)

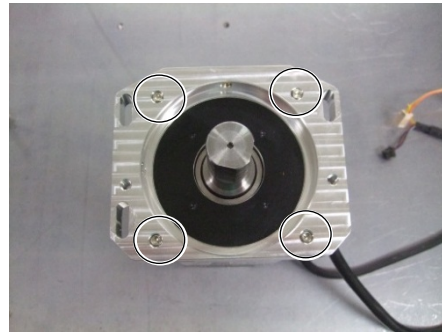

2. Mount the Joint #2 electromagnetic brake to the Joint #2 motor unit.

Hexagon socket set screws: 2-M6×6 (with a brass bushing)

Tightening torque:  $8.0 \pm 0.4 \text{ N}\cdot\text{m}$

Be careful of the assembly direction of the Joint #2 electromagnetic brake. (See the photo.)

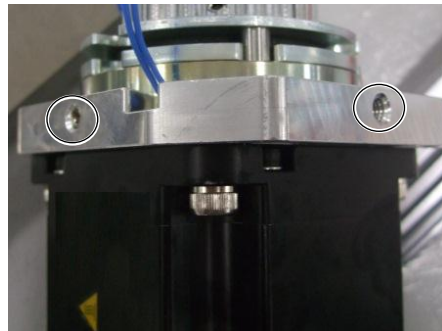

Fix the set screws while pressing the electromagnetic brake to the motor plate.

The brass bushing is not necessary for the screw for the flat surface (D-cut). Set the bushing to the other screw and then fix the screw.

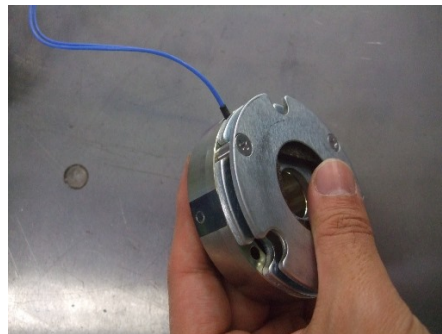

NOTE  If the screw positions are incorrect or the bushing is not set, it may cause damage on the side of the brake and may result in the part being unable to be removed.





3. Mount the drive boss and the pulley 1 to the Joint #2 motor unit.

Insert the pulley 1 so that the set screw is aligned to the flat surface of the motor shaft.

Fix the pulley 1 and the motor shaft.

Leave 0.5 mm between the pulley 1 and the electromagnetic brake.

The countersunk screw of the electromagnetic brake is projecting.

Using the feeler gauge (0.5 mm), leave a space for the projection.



**NOTE**  If there is no space for the projection, the parts may chafe while the motor is driving and it may result in breakage.

Hexagon socket set screws: 2-M5×12

Tightening torque:  $3.9 \pm 0.2$  N·m

If the drive boss and the pulley 1 are removed:

Align the end faces of the drive boss and the pulley 1, and then fix them.

Hexagon socket set screws: 2-M5×8 (with a brass bushing)

Tightening torque:  $3.9 \pm 0.2$  N·m

**NOTE**  If the screw positions are incorrect or the bushing is not set, it may cause damage on the side of the part and may result in the part being unable to be removed.

Set the set screws to the positions indicated in the right figure.

A: Pulley and motor shaft screws  
(D-cut part of the motor shaft × 2)

B: Pulley and drive boss screws  
Do not remove these screws.

C: Bushing

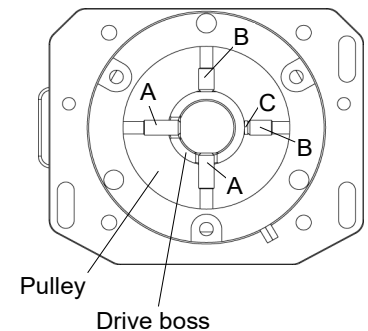

4. Put the Joint #2 motor unit in the Arm #1.
5. Set the timing belt around the pulley 1 and the pulley 2 and fix it temporarily.

Check that the teeth of the timing belt engage with these of the pulley.

As a rough guide of temporary fixing, check that the motor unit can be moved by hand, and it does not tilt when being pulled. If the belt is too loose or too tight, it will not have proper tension.

Hexagon socket set screws: 3-M5×25 (with a plain washer)



6. Apply tension to the Joint #2 timing belt and fix Joint #2 motor unit.

Joint #2 timing belt tension: 58 to 95 N

Belt tension meter setting values

Weight: 4.0 g/mm width × m span, Width: 14 mm,

Span: 146 mm

Hexagon socket set screws: 3-M5×25 (with a plain washer)

Tightening torque:  $8.0 \pm 0.4 \text{ N}\cdot\text{m}$

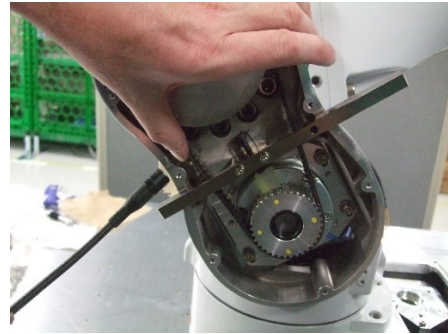

**NOTE**  Regarding belt tension:

- Jumping (position gap) may occur if the value is below the lower limit.
- Vibration (abnormal noise) or reduction in life of the parts may occur if the value exceeds the upper limit.
- When you replace with a new belt, belt extends and the belt tension may decrease in the initial stage. Make sure to operate the robot two to three days and check the belt tension again.

When using the belt tension tensile jig (maintenance part):

Fix the belt tension tensile jig (for J1, J2, and J3) with the screws (2-M4×35) and push the rubber against the pulley.

Tension is applied by pushing the set screw (M6×25) with the rubber.

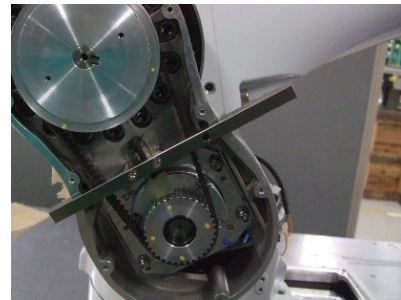

7. Install the brake power supply.

Cross recessed head screws with captive washer: 2-M3×6

Tightening torque:  $0.45 \pm 0.1 \text{ N}\cdot\text{m}$



8. Connect the following connectors.

Connectors: X121, X021, BT2, BR021



9. Remove the heat dissipation block and the heat dissipation sheet to the Arm #2.

Hexagon socket head cap bolts: 2-M4×10

Tightening torque:  $4.0 \pm 0.2$  N·m

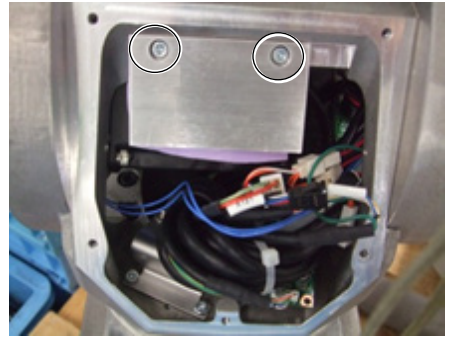

10. Mount the Arm #1 cover and the Arm #1 side cover.  
For details, refer to *Maintenance: 3. Covers*.

11. Perform calibration.  
For details, refer to *Maintenance: 16. Calibration*.

## 6.2 Joint #2- Replacing the Reduction Gear Unit

	Name		Qty.	Note	
Maintenance Parts	Reduction gear unit (Joint #2)	C8-A701*** (C8)	1	1674605	
		C8-A901** *(C8L)			
		C8-A1401*** (C8XL)			
	O-ring (Joint #2)	C8-A701*** (C8)	Arm #1	1	1263978
		C8-A901** *(C8L)	Arm #2	1	1656161
		C8-A1401*** (C8XL)	Arm #1	1	1670635
			Arm #2	1	1656140
Belt tensile jig*			1	1674582	
Tools	Hexagonal wrench	width across flats: 2.5 mm	1	For M3 hexagon socket head cap bolts For M5 hexagon socket set screws	
		width across flats: 3 mm	1	For M4 hexagon socket head cap bolts	
		width across flats: 4 mm	1	For M5 hexagon socket head cap bolts	
		width across flats: 5 mm	1	For M6 hexagon socket head cap bolts	
	Cross-point screwdriver (#2)		1	For cross recessed head screws	
	Torque wrench		1	For tightening torque control	
	Belt tension meter (0.5 mm)		2	For adjusting the pulley position	
	Belt tension meter		1	Refer: Unitta U-505	
	Cloth (cushioning)		1	For pressing arms	

\* The belt tensile jig is an assembly jig. Use the jig when adjusting belt tension.

The brake is mounted on each joint to prevent the arm from lowering due to its own weight while the Controller power is OFF or the motor is OFF status. The brake does not work during replacement. Be careful when performing maintenance work.

When removing the Joint #2 timing belt, tilt the Arm #2 and press it against the Arm #1.

Reference: *Maintenance: 6.1 Joint #2 - Replacing the Motor*, Removal step (2)

When pressing the arm, put a piece of cloth or a similar material between the arms to avoid contacting each other. This protects the arm surfaces from scratching and paint peeling off.

### Removal: Joint #2 Reduction gear unit

1. Remove the Joint #2 timing belt.

For details, refer to *Maintenance 6.3 Joint #2 - Replacing the Timing Belt*, Removal steps (1) to (3).

2. Remove the following parts.

Battery

Battery board

Battery connector

For details, refer to *Maintenance 11.2 Replacing the Battery Board*, Removal steps (3) to (6).

3. Remove the battery box.

Countersunk screws: 2-M3×8

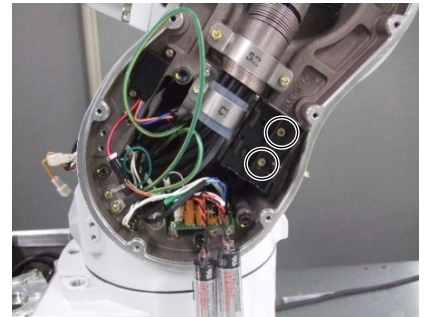

4. Arm #1 side arm fixing bolts.

Hexagon socket head cap bolts: 8-M6×25 (with a plain washer)



5. Remove the Joint #2 pulley 2 from the Joint #2 shaft.

Hexagon socket set screws: 2-M5×10

There is a brass bushing on one of the set screws.

Be careful not to lose it.

C8XL:

Remove the key from the shaft. The key will be used again. Be careful not to lose it.

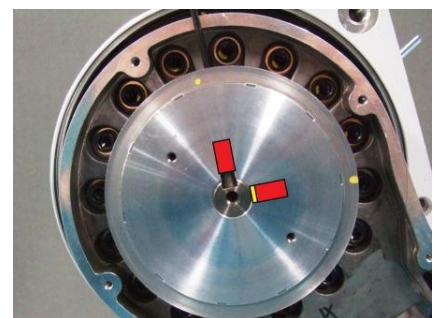

6. Pull out the grease tube on the Arm #1 side from the fitting.

The grease tube connects between the base and the Arm #1.

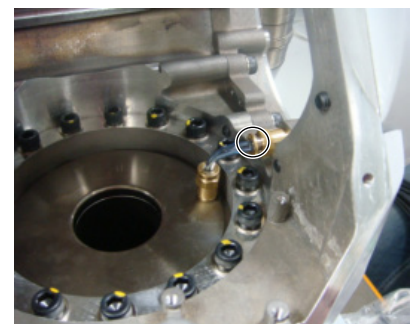





7. Remove the Arm #2.

Hexagon socket head cap bolts (with a plain washer)  
C8, C8L: 16-M5×30  
C8XL: 16-M6×35

Remove a wave washer on the Arm #1 side.  
The wave washer will be used again. Be careful not to lose it.

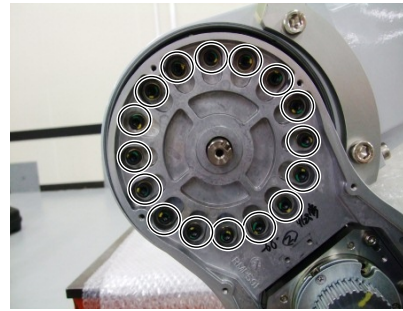
Wipe grease on the part while removing it.



 <p>CAUTION</p>	<ul style="list-style-type: none"><li>■ By removing the bolts, the Arm #1, #2, #3, #4, #5, and #6(end effector) can be separated. There is a possibility of hands and fingers being caught and/or damage or malfunction to the Manipulator. Be very careful when removing the arm. Have at least two workers so that one can support the Manipulator while the other worker is removing the bolts.</li><li>■ The Arms are connected by the internal cables. When replacing the parts, place the removed arm while not applying load on the cables. It may result in cable disconnection.</li></ul>
--	--

8. Remove the wave generator from the reduction gear unit.

If the wave generator unit does not come off easily, set the pulley 2 as shown in the photo to the shaft and pull out the parts.

Wipe grease on the part while removing it.



9. Remove the reduction gear unit from the Arm #2.

Hexagon socket head cap bolts (with plain washer)  
C8, C8L: 12-M5×40  
C8XL: 12-M6×45

Wipe grease on the part while removing it.

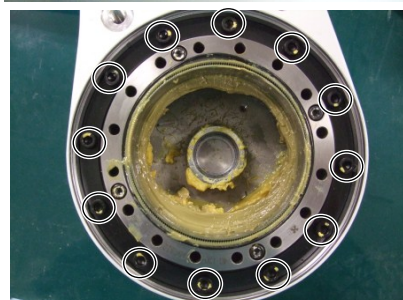

10. Remove the O-ring from the groove on the Arm #2.

Wipe grease on the part while removing it.



Installation: Joint #2 Reduction gear unit

1. Apply a thin coat of grease (SK-1A) to the O-ring.  
Fit the O-ring to the groove on the Arm #2.  
  
Do not allow the O-ring to come out of the groove.  
  
If the O-ring is swollen, damaged, or deteriorated, replace it with a new one.



2. Install the reduction gear unit to the Arm #2.

C8, C8L:

Hexagon socket head cap bolts: 12-M5×40

Tightening torque:  $10.0 \pm 0.5$  N·m

C8XL:

Hexagon socket head cap bolts: 12-M6×45

Tightening torque:  $18.0 \pm 0.9$  N·m

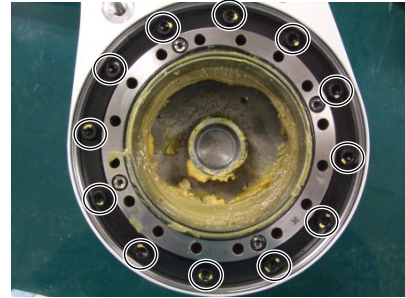

Installation face of the Arm #2 reduction gear unit has clearance holes.  
Install the reduction gear unit to match the screws and the clearance holes.

3. Grease the inner side of the flexspline.

Grease : SK-1A

Grease amount : C8, C8L: 55 g

C8XL: 102g

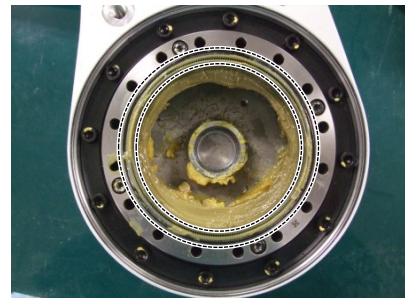

4. Insert the wave generator to the reduction gear unit and fix it.

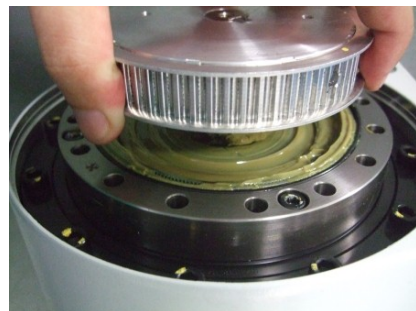



5. Apply a thin coat of grease (SK-1A) to the O-ring.  
Fit the O-ring to the groove on the reduction gear unit.  
Do not allow the O-ring to come out of the groove.  
If the O-ring is swollen, damaged, or deteriorated, replace it with a new one.

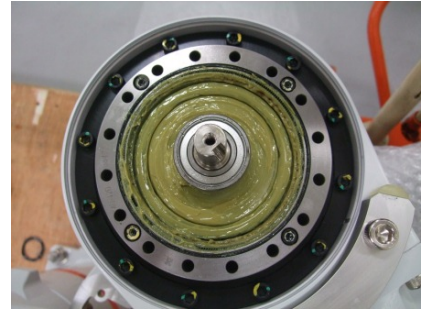

6. Temporarily fix the Arm #1 side arm to the Arm #1.  
At this time, set the wave washer to the Arm #1.  
Hexagon socket head cap bolts: 8-M6×25 (with a plain washer)



CAUTION

- There is a possibility of hands and fingers being caught and/or damage or malfunction to the Manipulator. Be very careful when installing the arm. Have at least two workers so that one can support the Manipulator while the other worker is removing the bolts.

7. Fix the Arm #2.

C8, C8L:

Hexagon socket head cap bolts: 16-M5×30  
(with a plain washer)

Tightening torque:  $10.0 \pm 0.5 \text{ N}\cdot\text{m}$

C8XL:

Hexagon socket head cap bolts: 16-M6×35  
(with a plain washer)

Tightening torque:  $18.0 \pm 0.9 \text{ N}\cdot\text{m}$

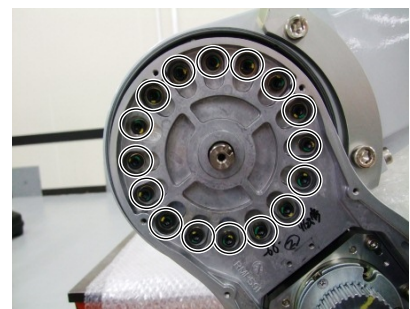

After fixing the Arm, check that there is no backlash or misalignment on the reduction gear unit by moving the Arm by hand.

8. After fixing the Arm #2, fix the Arm #1 side arm.

Hexagon socket head cap bolts: 8-M6×25 (with a plain washer)

Tightening torque:  $18.0 \pm 0.9$  N·m



9. Install the Joint #2 pulley 2 to the Joint #2 shaft.

Hexagon socket head cap bolts: 2-M5×10  
(with a brass washer)

Tightening torque:  $3.9 \pm 0.2$  N·m

C8, C8L:

Insert the pulley 2 so that one of the set screws is at the flat face of the shaft. The brass bushing is not necessary for the screw for the flat surface. Set the bushing to the other screw and then fix the screw.

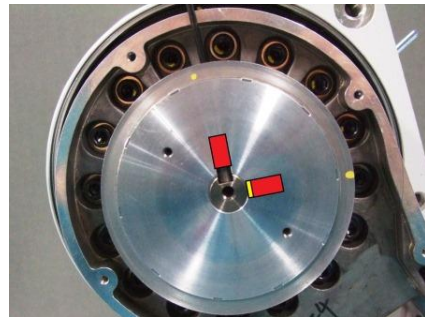

C8XL:

Set the key to the shaft and insert the pulley 2 while aligning to the key groove. The brass bushing is not necessary for the screw for the flat surface. Set the bushing to the other screw and then fix the screw.

**NOTE**  If the screw positions are incorrect or the bushing is not set, it may cause damage on the side of the brake and may result in the part being unable to be removed.

10. Install the battery box.

Countersunk screws: 2-M3×8

Tightening torque:  $0.45 \pm 0.1$  N·m

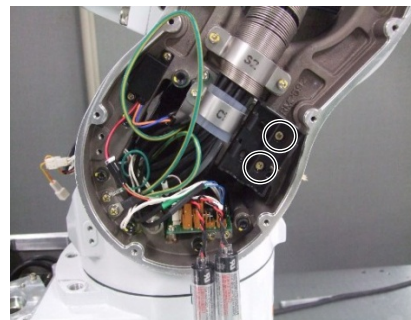

11. Install the following parts.

Battery

Battery board

Battery connector

For details, refer to *Maintenance 11.2 Replacing the Battery Board*, Installation steps (2) to (5).

12. Install the Joint #2 timing belt.

For details, refer to *Maintenance 6.3 Joint #2 – Replacing the Timing Belt*, Installation steps (1) to (2).

### 6.3 Joint #2 - Replacing the Timing Belt

	Name	Qty.	Note
Maintenance Parts	Timing belt (Joint #2)	C8-A701*** (C8)	1 475 mm 1655920
		C8-A901*** (C8L)	1 485 mm 1655924
		C8-A1401*** (C8XL)	1 540 mm 1655927
	Belt tensile jig *	1	1674582
Tools	Hexagonal wrench (width across flats: 4 mm)	1	For M5 hexagon socket head cap bolt
	Cross-point screwdriver	1	For cross recessed head screws
	Torque wrench	1	For tightening torque control
	Cloth (cushioning)	1	For pressing arms
	Belt tension meter	1	Refer: Unitta U-505

\* The belt tensile jig is an assembly jig. Use the jig when adjusting belt tension.

The brake is mounted on each joint to prevent the arm from lowering due to its own weight while the Controller power is OFF or the motor is OFF status. The brake does not work during replacement. Be careful when performing maintenance work.

When removing the Joint #2 motor, tilt the Arm #2 and press it against the Arm #1.

Reference: *Maintenance: 6.1 Joint #2 - Replacing the Motor*, Removal step (2)

When pressing the arm, put a piece of cloth or a similar material between the arms to avoid contacting each other. This protects the arm surfaces from scratching and paint peeling off.

#### Removal: Joint #2 Timing belt

- Follow Removal steps (1) through (4) of *Maintenance: 6.1 Joint #2 – Replacing the Motor*.
- Loosen the Joint #2 motor unit set screws.  
Hexagon socket head cap bolts: 3-M5×25  
(with a plain washer)
- Remove the Joint #2 timing belt.



#### Installation: Joint #2 Timing belt

- Pass the Joint #2 timing belt around the pulley 1 and the pulley 2 of the Joint #2.  
Pass the timing belt to the pulley 2 first, then, place it to the pulley 1.
- Secure the Joint #2 motor unit.  
For details, refer to *Maintenance: 6.1 Joint #2 – Replacing the Motor*, Installation steps (5) to (6) and (10) to (11).

### 6.4 Joint #2 - Replacing the Electromagnetic Brake

	Name	Qty.	Note	
Maintenance Parts	Electromagnetic brake (Joint #1, #2)	1	2172926	
	Belt tensile jig*	1	1674582	
Tools	Hexagonal wrench	width across flats: 2.5 mm	1	For M5 hexagon socket set screw
		width across flats: 3 mm	1	For M6 hexagon socket set screw
		width across flats: 4 mm	1	For M5 hexagon socket head cap bolt
		width across flats: 5 mm	1	For M6 hexagon socket head cap bolt
	Cross-point screwdriver	1	For cross recessed head screws	
	Torque wrench	1	For tightening torque control	
	Feeler gauge (0.5 mm)	2	For adjusting the pulley position	
	Belt tension meter	1	Refer: Unitta U-505	
Cloth (cushioning)	1	For pressing arms		

\* The belt tensile jig is an assembly jig. Use the jig when adjusting belt tension.

The brake is mounted on each joint to prevent the arm from lowering due to its own weight while the Controller power is OFF or the motor is OFF status. The brake does not work during replacement. Be careful when performing maintenance work.

When removing the Joint #2 motor, tilt the Arm #2 and press it against the Arm #1.

Reference: *Maintenance: 6.1 Joint #2 - Replacing the Motor*, Removal step (2)

When pressing the arm, put a piece of cloth or a similar material between the arms to avoid contacting each other. This protects the arm surfaces from scratching and paint peeling off.

#### Removal: Joint #2 Electromagnetic brake

1. Remove the Joint #2 electromagnetic brake.

For details, refer to *Maintenance: 6.1 Joint #2 – Replacing the Motor*, Removal steps (1) through (11).

#### Installation: Joint #2 Electromagnetic brake

1. Mount the Joint #2 electromagnetic brake to the Joint #2 motor unit.

For details, refer to *Maintenance: 6.1 Joint #2 – Replacing the Motor*, Installation steps (2) through (11).

## 7. Joint #3



- Do not connect or disconnect the motor connectors while the power to the robot system is turned ON. Connecting or disconnecting the motor connectors with the power ON is extremely hazardous and may result in serious bodily injury as the Manipulator may move abnormally, and also may result in electric shock and/or malfunction of the robot system.
- To shut off power to the robot system, disconnect the power plug from the power source. Be sure to connect the AC power cable to a power receptacle. DO NOT connect it directly to a factory power source.
- Before performing any replacement procedure, turn OFF the Controller and related equipment, and then disconnect the power plug from the power source. Performing any replacement procedure with the power ON is extremely hazardous and may result in electric shock and/or malfunction of the robot system.



- Be careful not to apply excessive shock to the motor shaft during replacement. The shock may shorten the life of the motors and encoder and/or damage them.
- Never disassemble the motor and the encoder. Disassembled motor and encoder will cause a positional gap and cannot be used again.

After parts have been replaced (motors, reduction gear units, electromagnetic brakes, timing belts, etc.), the Manipulator cannot perform positioning properly because a gap exists between the origin stored in each motor encoder and its corresponding origin stored in the Controller.

Therefore, it is necessary to match these origins after replacing the parts.

The process of aligning the two origins is called “Calibration”.

Refer to *Maintenance 16. Calibration* and perform the calibration after the parts replacement.

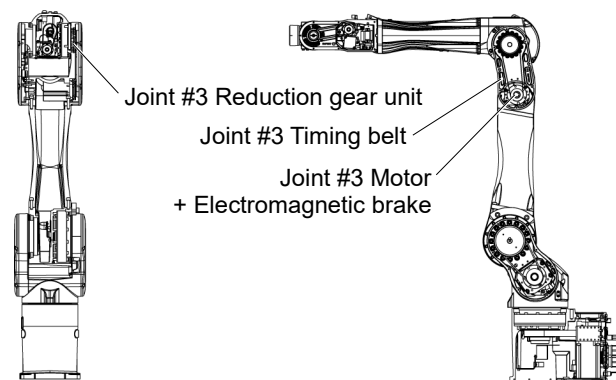

(Figure: C8-A1401\* (C8XL))

**7.1 Joint #3 - Replacing the Motor**

	Name		Qty.	Note
Maintenance Parts	AC servo motor 400 W		1	2168684
	Belt tensile jig*		1	1674582
Tools	Hexagonal wrench	width across flats: 2.5 mm	1	For M5 hexagon socket set screws
		width across flats: 3 mm	1	For M4 hexagon socket head cap bolts
		width across flats: 4 mm	1	For M5 hexagon socket head cap bolts
	Cross-point screwdriver (#2)		1	For cross recessed head screws
	Torque wrench		1	For tightening torque control
	Feeler gauge (0.5 mm)		2	For pulley position adjustment
	Belt tension meter		1	Refer: Unitta U-505
	Cloth (cushioning)		1	For pressing arms

\* The belt tensile jig is an assembly jig. Use the jig when adjusting belt tension.

The brake is mounted on each joint to prevent the arm from lowering due to its own weight while the Controller power is OFF or the motor is OFF status. The brake does not work during replacement. Be careful when performing maintenance work.

When removing the Joint #3 motor, tilt the Arm #2 and press it against the Arm #2.

Reference: *Maintenance: 7.1 Joint #3 - Replacing the Motor*, Removal step (2)

When pressing the arm, put a piece of cloth or a similar material between the arms to avoid contacting each other. This protects the arm surfaces from scratching and paint peeling off.

## Removal: Joint #3 Motor



- This procedure has possibility of hands and fingers being caught and/or damage or malfunction to the Manipulator. Be very careful when conducting maintenance.
- Do not loosen the bolts while the Arm #3 is not tilted.  
It may cause the belt come off and the Arm #3 falls down, and it is extremely hazardous. Be sure to do the Removal steps 1 and 2 before removing the motor.

1. Turn ON the Controller power.
2. Release the Joint #3 brake. Tilt the Arm #3 and push it against the Arm #2.

The Arm #3 falls by its weight when the Joint #3 motor unit is removed. Therefore, release the brake and tilt the Arm #3 in advance.

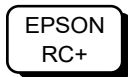

Command:  
>brake off, 3

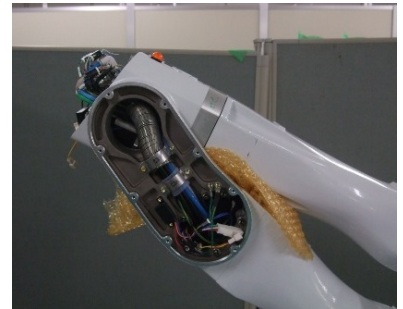

- There is a possibility of hands and fingers being caught and/or damage or malfunction to the Manipulator. Be very careful when moving the Manipulator.  
Put a cloth between the Arm #2 and Arm #3 so that the arms do not touch each other.

3. Turn OFF the Controller power.
4. Remove the Arm #2 side cover.  
For details, refer to *Maintenance: 3. Covers*.
5. Disconnect the following connectors.  
Connectors: X131, X031, BT3, BR031  
(Hold the clip to remove.)



Be careful not to drop the removed connectors inside the Arm.

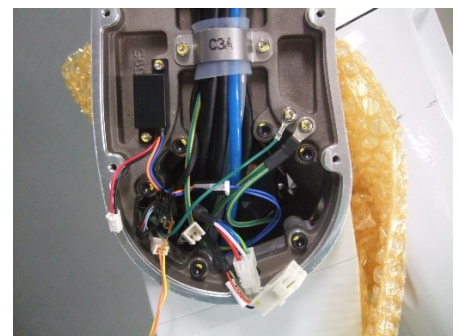



6. Remove the brake power supply.

Cross recessed head screws with captive washer: 2-M3×6

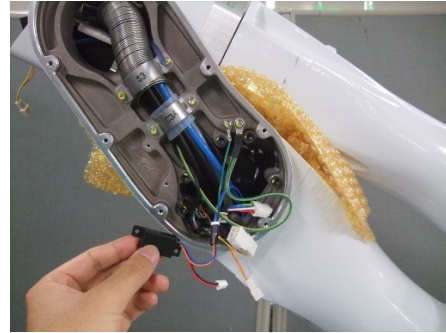

7. Loosen the bolts securing the Joint #3 motor unit and remove the belt.

Hexagon socket head cap bolts: 3-M4×20  
(with a plain washer)

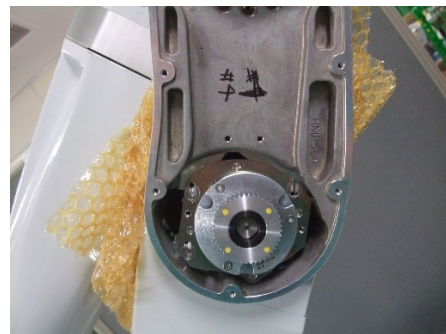
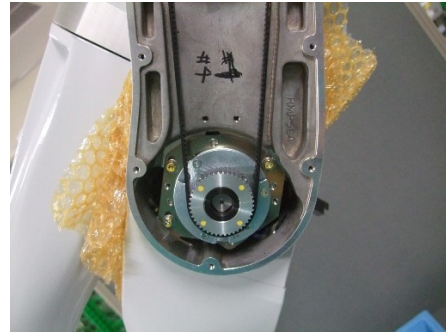

WARNING

- Loosening the bolts while the Arm #3 is not bent may cause the belt come off and the Arm #3 falls down, and it is extremely hazardous.

Be sure to do the Removal steps 1 and 2 before loosening the bolts.



8. Remove the Joint #3 motor unit.

NOTE Be careful not to drop the removed connectors inside the Arm.

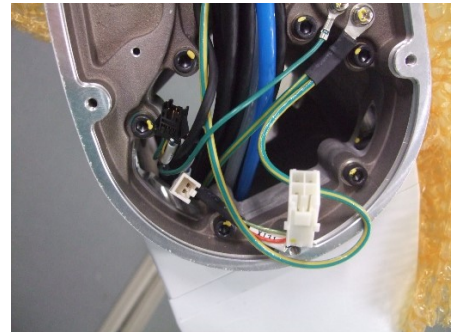
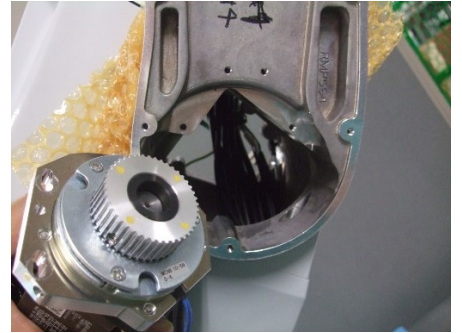

9. Remove the Joint #3 pulley 1 and the drive boss from the motor shaft of the Joint #3 motor unit.  
Remove two screws at the flat (D-cut) part of the motor shaft when viewing from above. (A in the figure)

Pulley and motor shaft screws (A)

Hexagon socket set screws: 2-M5×12

NOTE Do not remove the pulley and drive boss screws (B in the figure)



There is a brass bushing on one of the set screws.

If you removed the screws (B), be careful not to lose the brass bushing.

Pulley and drive boss screws (B)

Hexagon socket set screws: 2-M5×6

(with a brass bushing)

A: Pulley and motor shaft screws

(D-cut part of the motor shaft × 2)

B: Pulley and drive boss screws

Do not remove these screws.

C: Bushing

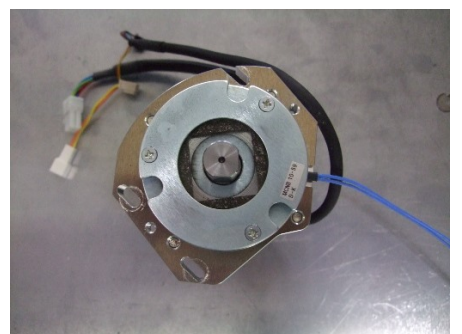
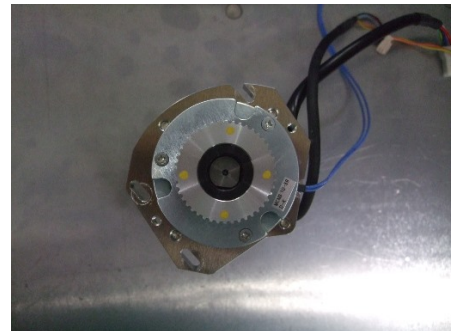
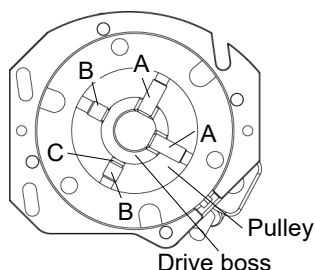

10. Remove the Joint #3 electromagnetic brake.

Hexagon socket set screws: 2-M5×10 (with a brass bushing)

The screws have a brass bushing.

Be careful not to lose them.



11. Remove the motor plate from the Joint #3 motor.

Hexagon socket head cap bolts: 4-M5×15

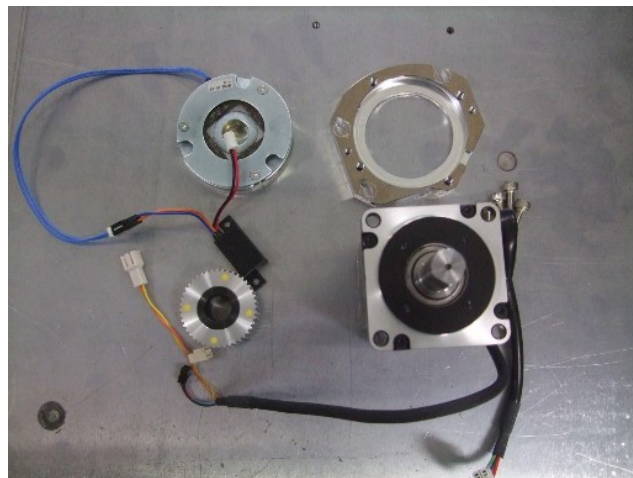
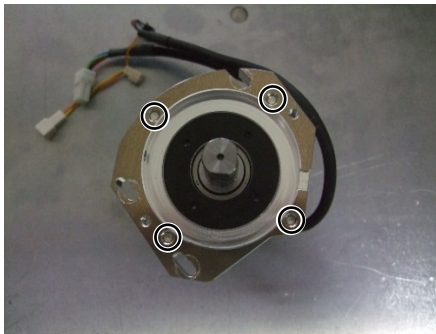

## Installation: Joint #3 Motor

1. Install the motor plate to the Joint #3 motor.

Hexagon socket head cap bolts: 4-M5×15

Tightening torque:  $8.0 \pm 0.4 \text{ N}\cdot\text{m}$

**NOTE**  Be careful of the assembly direction of the motor plate. (See the figure.)

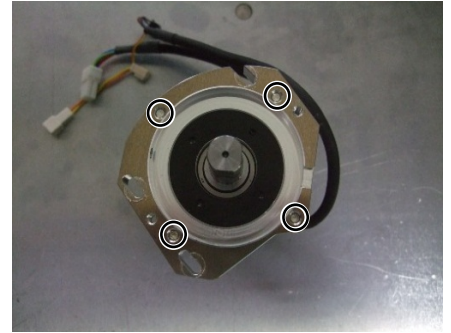

2. Mount the Joint #3 electromagnetic brake to the Joint #3 motor unit.

Hexagon socket set screws: 2-M5×10 (with a brass bushing)

Tightening torque:  $3.9 \pm 0.2 \text{ N}\cdot\text{m}$

**NOTE**  Be careful of the assembly direction of the Joint #3 electromagnetic brake. (See the photo.)

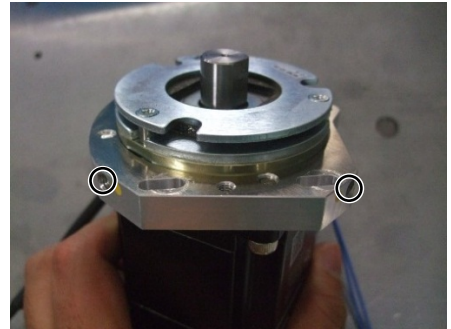

Fix the set screws while pressing the electromagnetic brake to the motor plate.

The brass bushing is not necessary for the screw for the flat surface (D-cut). Set the bushing to the other screw and then fix the screw.

**NOTE**  If the screw positions are incorrect or the bushing is not set, it may cause damage on the side of the brake and may result in the part being unable to be removed.

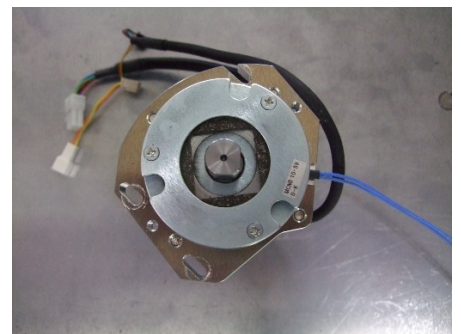

3. Mount the drive boss and the pulley 1 to the Joint #3 motor unit.

Insert the pulley 1 so that the set screw is aligned to the flat surface of the motor shaft.

Fix the pulley 1 and the motor shaft.  
 Leave 0.5 mm between the pulley 1 and the electromagnetic brake.  
 The countersunk screw of the electromagnetic brake is projecting. Using the feeler gauge (0.5 mm), leave a space for the projection.

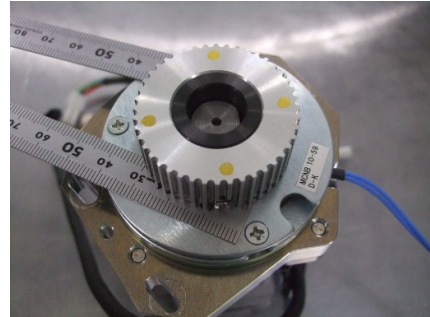

**NOTE** If there is no space for the projection, the parts may chafe while the motor is driving and it may result in breakage.

Hexagon socket set screws: 2-M5×12  
 Tightening torque:  $3.9 \pm 0.2$  N·m

If the drive boss and the pulley 1 are removed:  
 Align the end faces of the drive boss and the pulley 1, and then fix them.

Hexagon socket set screw: 2-M5×6 (with a brass bushing)  
 Tightening torque:  $3.9 \pm 0.2$  N·m

Set the set screws to the positions indicated in the right figure.

- A: Pulley and motor shaft screws  
 (D-cut part of the motor shaft × 2)
- B: Pulley and drive boss screws  
 Do not remove these screws.
- C: Bushing

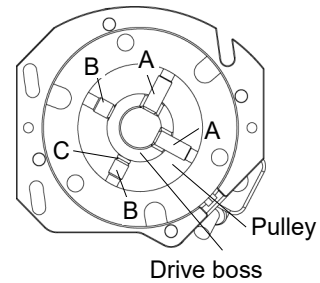

**NOTE** If the screw positions are incorrect or the bushing is not set, it may cause damage on the side of the part and may result in the part being unable to be removed.

4. Put the Joint #3 motor unit in the Arm #2.
5. Set the timing belt around the pulley 1 and the pulley 2 and fix it temporarily.

Check that the teeth of the timing belt engage with these of the pulley.  
 As a rough guide of temporary fixing, check that the motor unit can be moved by hand, and it does not tilt when being pulled. If the belt is too loose or too tight, it will not have proper tension.

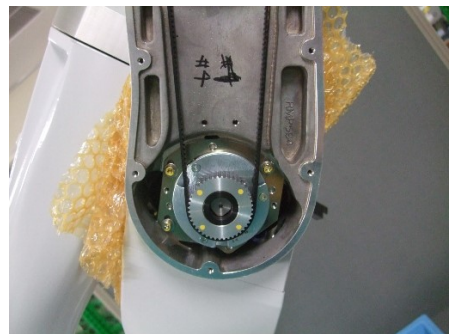

Hexagon socket set screws: 3-M4×20 (with a plain washer)



6. Apply tension to the Joint #3 timing belt and fix the Joint #3 motor unit.

Joint #3 timing belt tension: 25 to 85 N

Belt tension meter setting value

Weight: 2.5 g/mm width × m span, Width: 10 mm,

Span: 168 mm

Hexagon socket set screw: 3-M4×20 (with a plain washer)

Tightening torque:  $4.0 \pm 0.2$  N·m

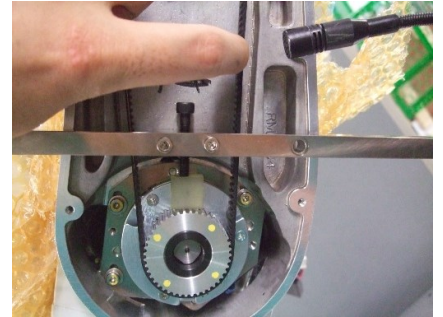

NOTE

☞ Regarding belt tension:

- Jumping (position gap) may occur if the value is below the lower limit
- Vibration (abnormal noise) or reduction of life of the parts may occur if the value exceeds the upper limit.
- When you replace with a new belt, belt extends and the belt tension may decrease in the initial stage. Make sure to operate the robot two to three days and check the belt tension again.

When using the belt tension tensile jig (maintenance part):

Fix the belt tension tensile jig (for J1, J2, J3) with the screws (2-M4×35) and push the rubber against the pulley.

Tension is applied by pushing the set screw (M6×25) with the rubber.

7. Install the brake power supply.

Cross recessed head screw with captive washer: 2-M3×6

Tightening torque:  $0.45 \pm 0.1$  N·m

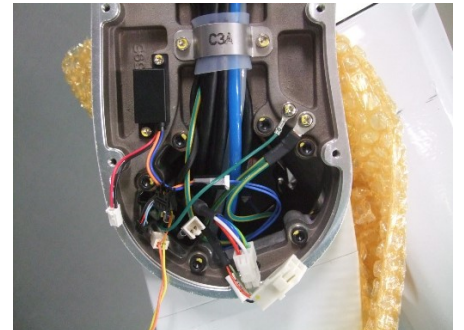

8. Connect the following connectors.

Connectors: X131, X031, BT3, BR031



9. Install the Arm #2 side cover.

For details, refer to *Maintenance: 3. Covers.*

10. Perform the calibration.

For details, refer to *Maintenance: 16. Calibration.*

## 7.2 Joint #3 - Replacing the Reduction Gear Unit

	Name		Qty.	Note	
Maintenance Parts	Reduction gear unit (Joint #3)	C8-A701*** (C8)	1	1674607	
		C8-A901*** (C8L)			
		C8-A1401*** (C8XL)	1	1674608	
	O-ring (Joint #3)	Arm #2 side	1	1263977	
		Arm #3 side	1	1510528	
	Belt tensile jig*		1	1674582	
Tools	Hexagonal wrench	width across flats: 2.5 mm	1	For M3 hexagon socket head cap bolts For M5 hexagon socket set screws	
		width across flats: 3 mm	1	For M4 hexagon socket head cap bolts	
		width across flats: 4 mm	1	For M5 hexagon socket head cap bolts	
		width across flats: 5 mm	1	For M6 hexagon socket head cap bolts	
		Cross-point screwdriver (#2)		1	For cross recessed head screws
		Torque wrench		1	For tightening torque control
		Feeler gauge (0.5 mm)		2	For adjusting the pulley position
		Belt tension meter		1	Refer: Unitta U-505
		Cloth (cushioning)		1	For pressing arms

\* The belt tensile jig is an assembly jig. Use the jig when adjusting belt tension.

The brake is mounted on each joint to prevent the arm from lowering due to its own weight while the Controller power is OFF or the motor is OFF status. The brake does not work during replacement. Be careful when performing maintenance work.

When removing the Joint #3 timing belt, tilt the Arm #2 and press it against the Arm #2.

Reference: *Maintenance: 7.1 Joint #3 - Replacing the Motor*, Removal step (2)

When pressing the arm, put a piece of cloth or a similar material between the arms to avoid contacting each other. This protects the arm surfaces from scratching and paint peeling off.

## Removal: Joint #3 Reduction gear unit

1. Remove the Joint #3 timing belt.

For details, refer to *Maintenance 7.3 Joint #3 - Replacing the Timing Belt*, Removal steps (1) to (3).

2. Remove the Arm #2 side arm fixing bolts.

Hexagon socket head cap bolts: 6-M5×20 (with a plain washer)



3. Remove the Joint #3 pulley 2 from the Joint #3 shaft.

Hexagon socket set screws

C8, C8L: 2-M5×10

C8XL: 2-M5×12

There is a brass bushing on one of the set screws.  
Be careful not to lose it.

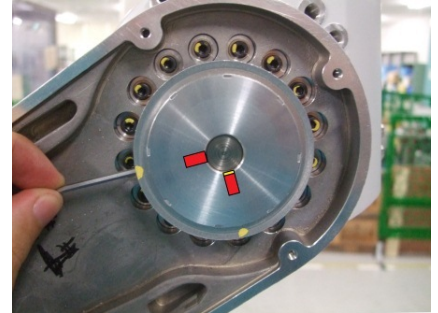

4. Remove the Arm #3.

Hexagon socket head cap bolts: 16-M4×25 (with a plain washer)

Remove a wave washer on the Arm #1 side.

The wave washer will be used again. Be careful not to lose it.

Wipe grease on the parts while removing them.



CAUTION

- By removing the bolts, the Arm #2 side arm, the Arm #3, #4, #5, and #6(end effector) can be separated. There is a possibility of hands and fingers being caught and/or damage or malfunction to the Manipulator. Be very careful when removing the arm. Have at least two workers so that one can support the Manipulator while the other worker is removing the bolts.
- The Arms are connected by the internal cables. When replacing the parts, place the removed arm while not applying load on the cables. It may result in cable disconnection.

5. Remove the wave generator from the reduction gear unit.

If the wave generator unit does not come off easily, set the pulley 2 as shown in the photo to the shaft and pull out the parts.

Wipe grease on the wave generator while removing it.

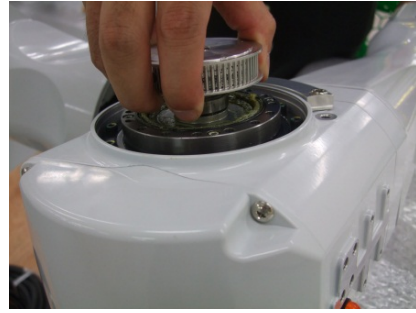

6. Remove the reduction gear unit from the Arm #3.

Hexagon socket head cap bolts: 12-M4×30

Wipe grease on the reduction gear unit while removing it.



7. Remove the O-ring from the groove on the Arm #3.

Wipe grease on the O-ring while removing it.

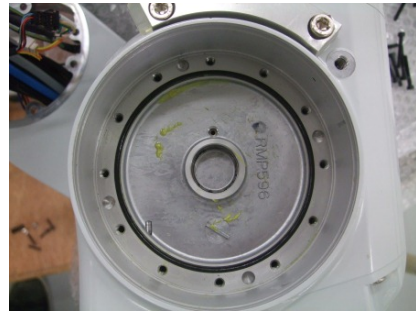



## Installation: Joint #3 Reduction gear unit

1. Apply a thin coat of grease (SK-1A) to the O-ring.  
Fit the O-ring into the groove on the Arm #3.

Do not allow the O-ring to come out of the groove.

If the O-ring is swollen, damaged, or deteriorated, replace it with a new one.

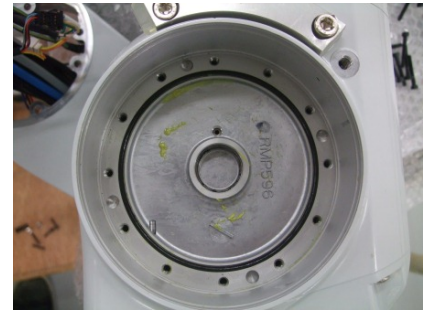

2. Install the reduction gear unit to the Arm #3.

Hexagon socket head cap bolts: 12-M4×30

Tightening torque:  $5.5 \pm 0.2 \text{ N}\cdot\text{m}$

Installation face of the Arm #3 reduction gear unit has clearance holes.

Install the reduction gear unit to match the screws and the clearance holes.



3. Grease the inner side of the flexspline.

Grease: SK-1A

Grease amount: 26 g

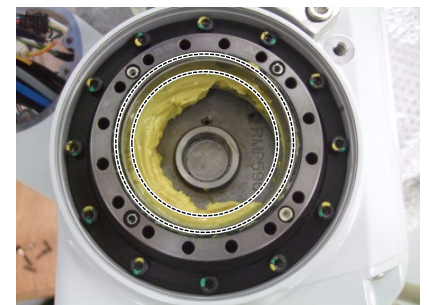

4. Insert the wave generator to the reduction gear unit and fix it.



5. Apply a thin coat of grease (SK-1A) to the O-ring.  
Fit the O-ring into the groove on the reduction gear unit.

Do not allow the O-ring to come out of the groove.

If the O-ring is swollen, damaged, or deteriorated, replace it with a new one.



6. Temporarily fix the Arm #1 side arm to the Arm #2.  
At this time, set the wave washer to the Arm #2.

Hexagon socket head cap bolts: 6-M5×20 (with a plain washer)



<p>CAUTION</p>	<p>■ There is a possibility of hands and fingers being caught and/or damage or malfunction to the Manipulator. Be very careful when installing the arm. Have at least two workers so that one can support the Manipulator while the other worker is removing the bolts.</p>
----------------	---

7. Fix the Arm #3.

Hexagon socket head cap bolts: 16-M4×25 (with a plain washer)

Tightening torque:  $5.5 \pm 0.2 \text{ N}\cdot\text{m}$

After fixing the Arm, check that there is no backlash or misalignment on the reduction gear unit by moving the Arm by hand.

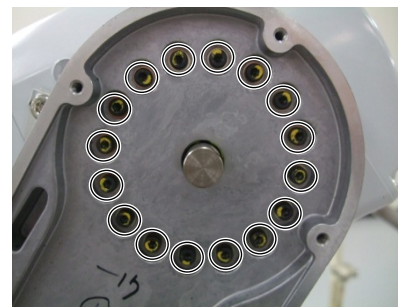

8. After fixing the Arm #3, fix the Arm #2 side arm.

Hexagon socket head cap bolts: 6-M5×20 (with a plain washer)

Tightening torque:  $10.0 \pm 0.5 \text{ N}\cdot\text{m}$



9. Install the Joint #3 pulley 2 to the Joint #3 shaft.

Hexagon socket head cap bolts (with 1 brass bushing)

C8, C8L: 2-M5×10

C8XL: 2-M5×12

Tightening torque:  $3.9 \pm 0.2$  N·m

 NOTE Insert the pulley 2 so that one of the set screws is at the flat face of the shaft. The brass bushing is not necessary for the screw for the flat surface. Set the bushing to the other screw and then fix the screw.

If the screw positions are incorrect or the bushing is not set, it may cause damage on the side of the brake and may result in the part being unable to be removed.

10. Install the Joint #3 timing belt.

For details, refer to *Maintenance 7.3 Joint #2 – Replacing the Timing Belt*, Installation steps (1) to (2).

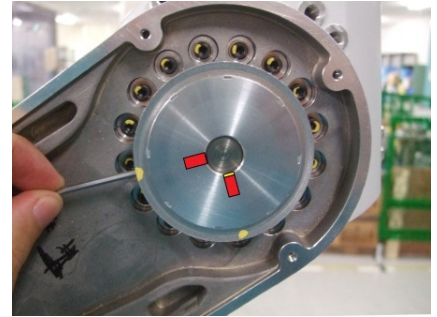

### 7.3 Joint #3 - Replacing the Timing Belt

	Name	Qty.	Note
Maintenance Parts	Timing belt (Joint #3)	C8-A701*** (C8)	1 471 mm 1655915
		C8-A901*** (C8L)	1 480 mm 1655918
		C8-A1401*** (C8XL)	1 501 mm 1655919
	Belt tensile jig*	1	1674582
Tools	Hexagonal wrench (width across flats: 3 mm)	1	For M4 hexagon socket head cap bolt
	Cross-point screwdriver (#2)	1	For cross recessed head screws
	Torque wrench	1	For tightening torque control
	Cloth (cushioning)	1	For pressing arms
	Belt tension meter	1	Refer: Unitta U-505

\* The belt tensile jig is an assembly jig. Use the jig when adjusting belt tension.

The brake is mounted on each joint to prevent the arm from lowering due to its own weight while the Controller power is OFF or the motor is OFF status. The brake does not work during replacement. Be careful when performing maintenance work.

When removing the Joint #3 motor, tilt the Arm #2 and press it against the Arm #2.

Reference: *Maintenance: 7.1 Joint #3 - Replacing the Motor*, Removal step (2)

When pressing the arm, put a piece of cloth or a similar material between the arms to avoid contacting each other. This protects the arm surfaces from scratching and paint peeling off.

#### Removal: Joint #3 Timing belt

- Follow Removal steps (1) through (4) of *Maintenance: 7.1 Joint #3 – Replacing the Motor*.
- Loosen the Joint #3 motor unit set screw.  
Hexagon socket head cap bolts: 3-M4×20  
(with a plain washer)
- Remove the Joint #3 timing belt.

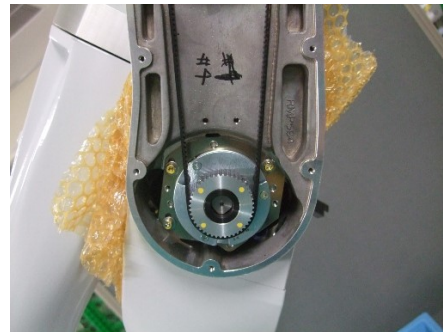

#### Installation: Joint #3 Timing belt

- Pass the Joint #3 timing belt around the pulley 1 and the pulley 2 of the Joint #3.  
Pass the timing belt to the pulley 2 first, then, place the timing belt to the pulley 1.
- Secure the Joint #2 motor unit.  
For details, refer to *Maintenance: 7.1 Joint #3 – Replacing the Motor*, Installation steps (5) to (6) and (9) to (10).

## 7.4 Joint #3 - Replacing the Electromagnetic Brake

	Name	Qty.	Note	
Maintenance Parts	Electromagnetic brake (Joint #3)	1	2172927	
	Belt tensile jig*	1	1674582	
Tools	Hexagonal wrench	width across flats: 2.5 mm	1	For M5 hexagon socket set screw
		width across flats: 3 mm	1	For M4 hexagon socket head cap bolt
		width across flats: 4 mm	1	For M5 hexagon socket head cap bolt
	Cross-point screwdriver (#2)	1	For cross recessed head screws	
	Torque wrench	1	For tightening torque control	
	Feeler gauge (0.5 mm)	2	For adjusting the pulley position	
	Belt tension meter	1	Refer: Unitta U-505	
Cloth (cushioning)	1	For pressing arms		

\* The belt tensile jig is an assembly jig. Use the jig when adjusting belt tension.

The brake is mounted on each joint to prevent the arm from lowering due to its own weight while the Controller power is OFF or the motor is OFF status. The brake does not work during replacement. Be careful when performing maintenance work.

When removing the Joint #3 motor, tilt the Arm #2 and press it against the Arm #2.

Reference: *Maintenance: 7.1 Joint #3 - Replacing the Motor*, Removal step (2)

When pressing the arm, put a piece of cloth or a similar material between the arms to avoid contacting each other. This protects the arm surfaces from scratching and paint peeling off.

### Removal: Joint #3 Electromagnetic brake

1. Remove the Joint #3 electromagnetic brake.

For details, refer to *Maintenance: 7.1 Joint #3 – Replacing the Motor*, Removal steps (1) through (10).

### Installation: Joint #3 Electromagnetic brake

1. Mount the Joint #3 electromagnetic brake to the Joint #3 motor unit.

For details, refer to *Maintenance: 7.1 Joint #3 – Replacing the Motor*, Installation steps (2) through (10).

## 8. Joint #4

 WARNING	<ul style="list-style-type: none"> <li>■ Do not connect or disconnect the motor connectors while the power to the robot system is turned ON. Connecting or disconnecting the motor connectors with the power ON is extremely hazardous and may result in serious bodily injury as the Manipulator may move abnormally, and also may result in electric shock and/or malfunction of the robot system.</li> <li>■ To shut off power to the robot system, disconnect the power plug from the power source. Be sure to connect the AC power cable to a power receptacle. DO NOT connect it directly to a factory power source.</li> <li>■ Before performing any replacement procedure, turn OFF the Controller and related equipment, and then disconnect the power plug from the power source. Performing any replacement procedure with the power ON is extremely hazardous and may result in electric shock and/or malfunction of the robot system.</li> </ul>
--	---

 CAUTION	<ul style="list-style-type: none"> <li>■ Be careful not to apply excessive shock to the motor shaft during replacement. The shock may shorten the life of the motors and encoder and/or damage them.</li> <li>■ Never disassemble the motor and the encoder. Disassembled motor and encoder will cause a positional gap and cannot be used again.</li> </ul>
--	--

After parts have been replaced (motors, reduction gear units, timing belts, etc.), the Manipulator cannot perform positioning properly because a gap exists between the origin stored in each motor encoder and its corresponding origin stored in the Controller.

Therefore, it is necessary to match these origins after replacing the parts. The process of aligning the two origins is called “Calibration”.

Refer to *Maintenance 16. Calibration* and perform the calibration after the parts replacement.

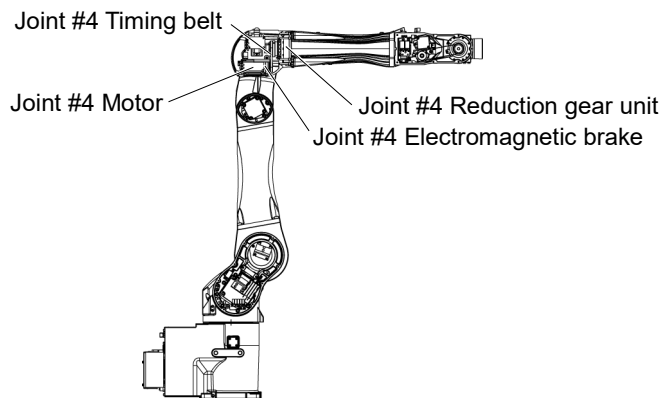

(Figure: C8-A1401\* (C8XL))

## 8.1 Joint #4 - Replacing the Motor

	Name	Qty.	Note	
Maintenance Parts	AC servo motor 100 W	1	2172051 (common to Joints #4, #5, #6)	
	Belt tensile jig*	1	1674582	
Tools	Hexagonal wrench	width across flats: 2 mm	1	For M4 hexagon socket set screws
		width across flats: 2.5 mm	1	For M3 hexagon socket head cap bolts
		width across flats: 3 mm	1	For M4 hexagon socket head cap bolts
	Cross-point screwdriver (#2)	1	For cross recessed head screws	
	Feeler gauge (0.5 mm)	2	For pulley position adjustment	
	Belt tension meter	1	Refer: Unitta U-505	

\* The belt tensile jig is an assembly jig. Use the jig when adjusting belt tension.

The brake is mounted on each joint to prevent the arm from lowering due to its own weight while the Controller power is OFF or the motor is OFF status. The brake does not work during replacement. Be careful when performing maintenance work.

**NOTE** The motors are common for Joints #4, #5, and #6.



The Joints #5 and #6 motors have an identification label for preventing misconnection of the connectors. The label is not necessary for the Joint #4 motor. (There is no connector identification label for the Joint #4.)



Removal: Joint #4 Motor

1. Turn OFF the Controller power.
2. Remove the following covers.
  - Arm #3 cover
  - Arm #3 maintenance cover
  - Arm #2 side coverFor details, refer to *Maintenance: 3. Covers*.
3. Pull out the cables from the Arm #3 and disconnect the following connectors.
  - Connector: X141, X041, BT4, BR041
  - (Hold the clip to remove.)
4. Remove the brake power supply.
  - Cross recessed head screws with captive washer: 2-M3×6

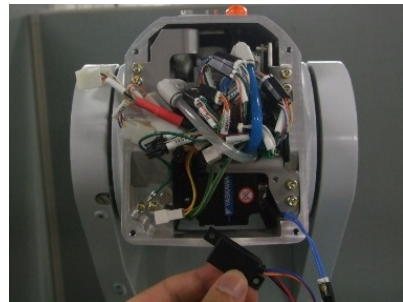
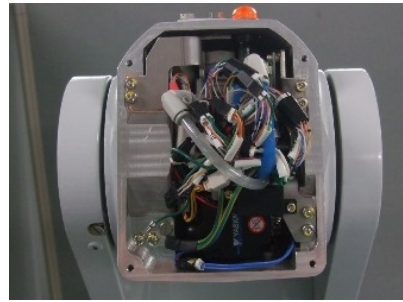

5. Remove the cable bracket.
  - Hexagon socket head cap bolts: 2-M4×10

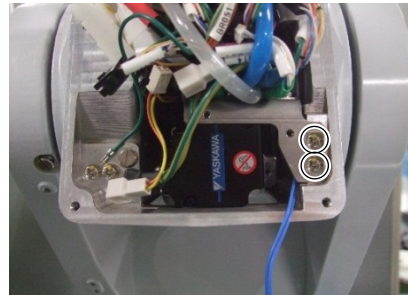

6. Remove the Joint #4 motor unit from the Arm #3.
  - Hexagon socket head cap bolts: 2-M4×15
  - (with a small plain washer)

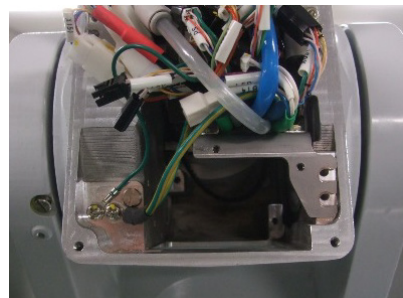
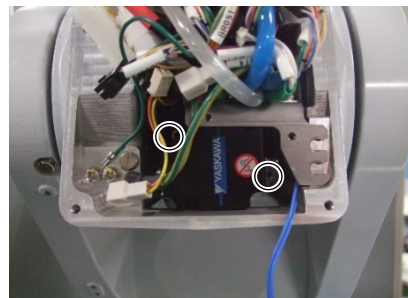



- Remove the Joint #4 pulley 1 and the drive boss from the motor shaft of the Joint #4 motor unit.

Pulley 1 and drive boss screws

Hexagon socket set screws: 2-M4×4 (with a brass bushing)

Drive boss and motor shaft screws

Hexagon socket set screws: 2-M4×4

There is a brass bushing on one of the set screws fixing the drive boss and the pulley. Be careful not to lose it.

A: Pulley and motor shaft screws

B: Pulley and drive boss screws

C: Bushing

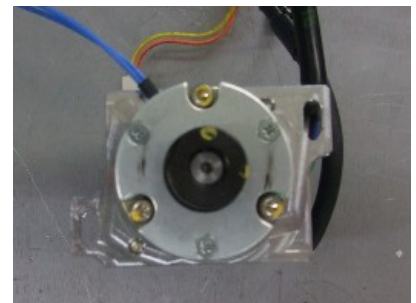
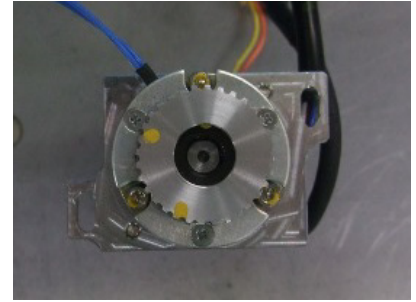
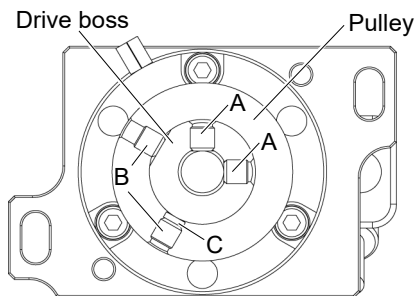

- Remove the Joint #4 electromagnetic brake.

Hexagon socket set screws: 3-M3×15 (with a spacer)

Be careful not to lose the spacers.

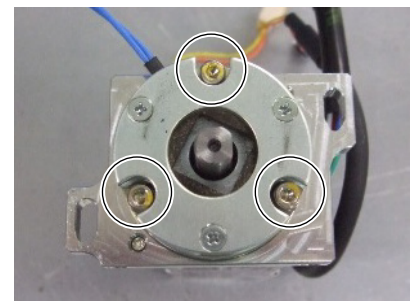

- Remove the motor plate from the Joint #4 motor.

Hexagon socket head cap bolts: 2-M4×10

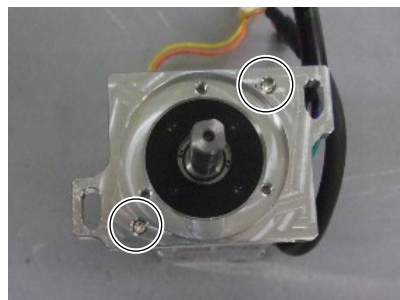

Installation: Joint #4 Motor

1. Install the motor plate to the Joint #4 motor.

Hexagon socket head cap bolts: 2-M4×10

Tightening torque:  $4.0 \pm 0.2 \text{ N}\cdot\text{m}$

NOTE Be careful of the assembly direction of the motor plate.

 (See the photo.)

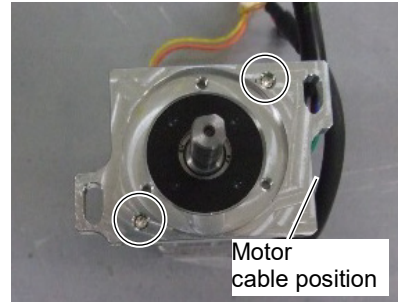

2. Mount the Joint #4 electromagnetic brake to the Joint #4 motor unit. Set the spacers between the hexagon socket set screws and the Joint #4 electromagnetic brake.

Hexagon socket set screws: 3-M3×15 (with a spacer)

Tightening torque:  $2.0 \pm 0.1 \text{ N}\cdot\text{m}$

NOTE Be careful of the direction of the Joint #4 electromagnetic brake

 wire. (See the photo.)

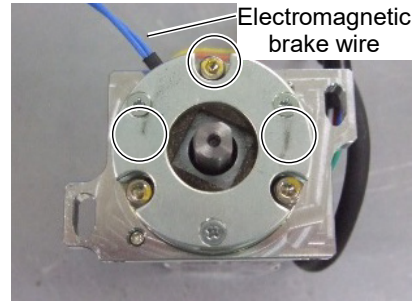

3. Mount the drive boss and the pulley 1 to the Joint #4 motor unit.

Fix the drive boss and the motor shaft.

There is an uneven part for the feeler gauge (0.5 mm) on the boss.

Use the uneven part to leave 0.5 mm space.

NOTE If there is no space, the parts may chafe while the motor is

 driving and it may result in breakage while the motor is moving.



Set the set screws to the positions indicated in the figure.

A: Pulley and motor shaft screws

B: Pulley and drive boss screws

C: Bushing

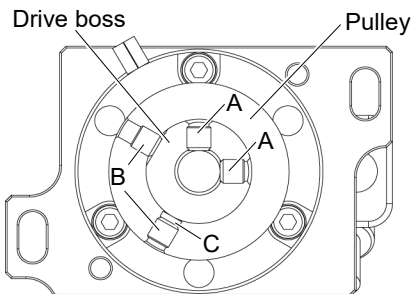

NOTE If the screw positions are incorrect or the bushing is not set, it

 may cause damage on the side of the part and may result in the part being unable to be removed.

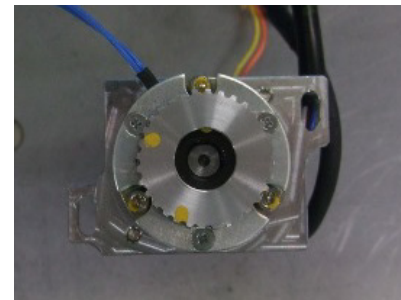
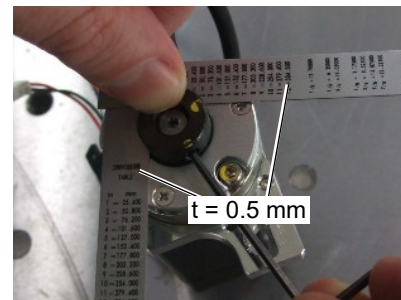

Drive boss and the motor shaft:

Hexagon socket set screws: 2-M4×4

Tightening torque:  $2.5 \pm 0.2$  N·m

Align the screws to the two flat faces of the motor shaft and fix them.

Drive boss and the pulley 1:

Hexagon socket set screws: 2-M4×4 (with a brass bushing)

Tightening torque:  $2.5 \pm 0.2$  N·m

Fix the set screws while pressing the pulley 1 to the drive boss.

The brass bushing is not necessary for the screw for the flat surface (D-cut). Set the bushing to the other screw and then fix the screw.

4. Put the Joint #4 motor unit inside the Arm #4.
5. Pass the timing belt around the pulley 1 and pulley 2 and temporarily fix it.

Hexagon socket head cap bolts: 2-M4×15 (with a washer)

Check that the teeth of the timing belt engage with these of the pulley.

As a rough guide of temporary fixing, check that the motor unit can be moved by hand, and it does not tilt when being pulled.

If the belt is too loose or too tight, it will not have proper tension.

6. Apply tension to the Joint #4 timing belt and fix the Joint #4 motor unit.

Joint #4 timing belt tension: 15 to 30 N

Belt tension meter setting value

Weight:  $2.5 \text{ g/mm width} \times \text{m span}$ , Width: 6 mm, Span: 61 mm

Hexagon socket head cap bolt: 2-M4×15 (with a plain washer)

Tightening torque:  $4.0 \pm 0.2$  N·m

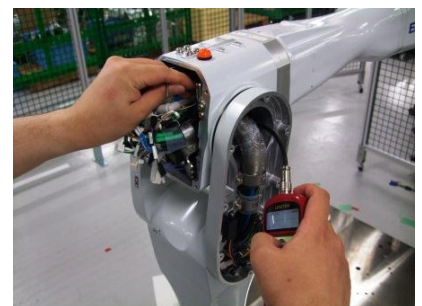
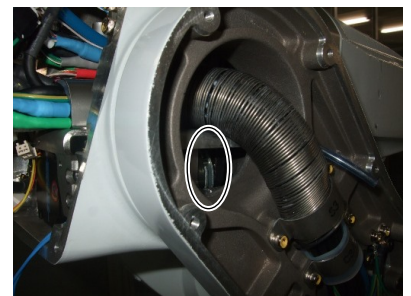
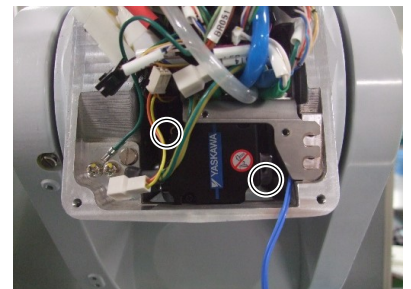



Regarding belt tension:

- NOTE  - Jumping (position gap) may occur if the value is below the lower limit.
- Vibration (abnormal noise) or reduction in life of the parts may occur if the value exceeds the upper limit.
  - When you replace with a new belt, belt may stretch and the belt tension will decrease in the initial stage of operation. Make sure to operate the robot two to three days and check the belt tension again.

When using the belt tension tensile jig (maintenance part):

Fix the belt tension tensile jig (for J4) to the Joint #4 motor plate.

Hexagon socket head cap bolt: 2-M4×15

Push the belt tension tensile jig (for J4, J5, and J6) against the Arm #3 as shown in the photo. Insert the screw to the through hole at the center and fix it lightly to the hole for the belt tension tensile jig.

Hexagon socket head cap bolt: M4×15

Tension is applied as the Joint #4 motor unit is stretched by tightening the screw.



7. Install the plate for fixing the cables.

Hexagon socket head cap bolts: 2-M4×10

8. Install the brake power supply to the plate.

Install the brake power supply so that the cable is facing to the left.

Cross recessed head screw with captive washer: 2-M3×6

Tightening torque:  $0.45 \pm 0.1$  N·m

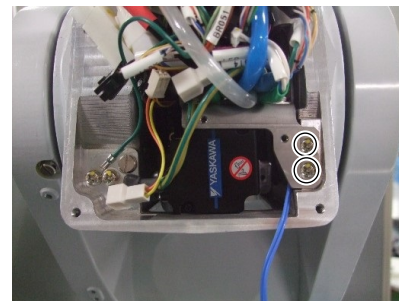

9. Connect the following connectors.

Connectors: X141, X041, BT4, BR041

10. Install the following cover.

Arm #3 cover

Arm #3 maintenance cover

Arm #2 side cover

For details, refer to *Maintenance: 3. Covers*.

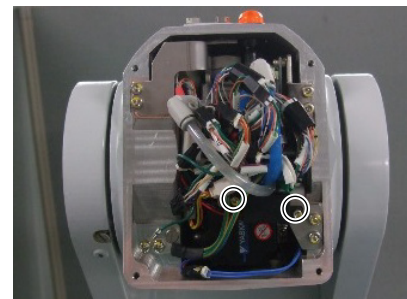

11. Calibrate the Joint #4.

For details, refer to *Maintenance: 16. Calibration*.

## 8.2 Joint #4 - Replacing the Reduction Gear Unit

	Name		Qty.	Note
Maintenance Parts	Reduction gear unit (Joint #4)	C8-A701*** (C8)	1	1674609
		C8-A1401*** (C8XL)		
		C8-A901*** (C8L)	1	1675434
	Belt tensile jig*	1	1674582	
Tools	Hexagonal wrench	width across flats: 2.5 mm	1	For M3 hexagon socket head cap bolts
		width across flats: 3 mm	1	For M4 hexagon socket head cap bolts
		width across flats: 4 mm	1	For M5 hexagon socket head cap bolts
		width across flats: 5 mm	1	For M6 hexagon socket head cap bolts
	Cross-point screwdriver (#2)	1	For cross recessed head screws	
	Torque wrench	1	For tightening torque control	
	Belt tension meter	1	Refer: Unitta U-505	

\* The belt tensile jig is an assembly jig. Use the jig when adjusting belt tension.

The brake is mounted on each joint to prevent the arm from lowering due to its own weight while the Controller power is OFF or the motor is OFF status. The brake does not work during replacement. Be careful when performing maintenance work.

Removal: Joint #4 Reduction gear unit

1. Turn OFF the Controller power.
2. Remove the Arm #4 side cover and Arm #3 cover.

For details, refer to *Maintenance 3. Covers*.

3. Remove the Joints #5 and #6 motors.

For details, refer to the Removal steps in *Maintenance 9.1 Joint #5 - Replacing the Motor* and *Maintenance 10.1 Joint #6 - Replacing the Motor*.

4. Remove the cables passing through the Arm #4 as shown in the photo.

For details, refer to the Removal steps in *Maintenance 4.1 Cable Unit*.



5. Loosen the fixing bolts of the Joint #4 motor plate and remove the belt. (Do not remove the Joint #4 motor.)

Hexagon socket head cap bolts: 2-M4×15  
(with a small plain washer)

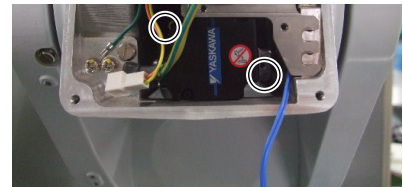

6. Remove the bolts fixing the J4 flange, and remove the Arm #4 from the Arm #3.

To remove all bolts, change the position of the Joint #4 by rotating it.

Hexagon socket head cap bolts: 8-M5×30

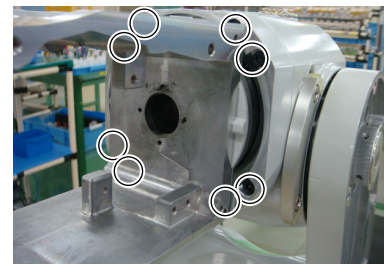

C8L:

The bolts can be removed from the four through holes on the extension flange of the Arm #4.

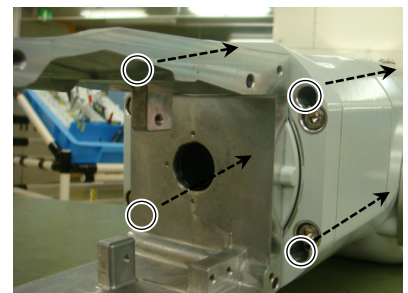

7. Remove the bolts fixing the J4 flange and the Joint #4 reduction gear unit.

Hexagon socket head cap bolts: 16-M3×20

8. Remove the wave generator of the Joint #4 reduction gear unit together with the J4 flange.

If the wave generator does not come off easily, insert a tool in a gap between the J4 flange and the Arm and remove the wave generator little by little.

Be careful not to damage the parts.

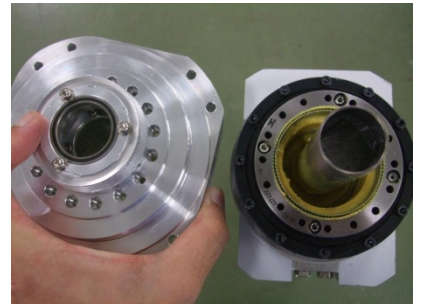
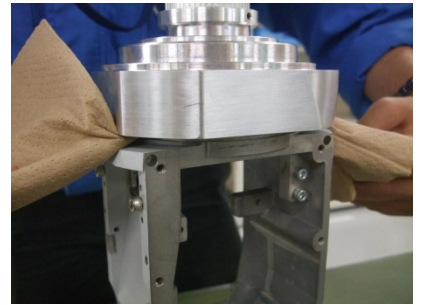
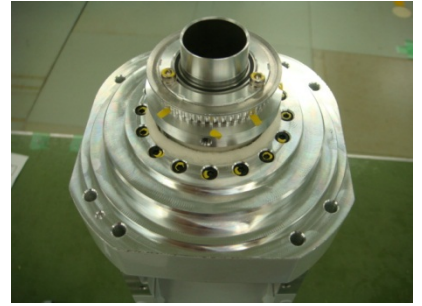

9. Remove the Joint #4 reduction gear unit.

Hexagon socket head cap bolts: 12-M3×28

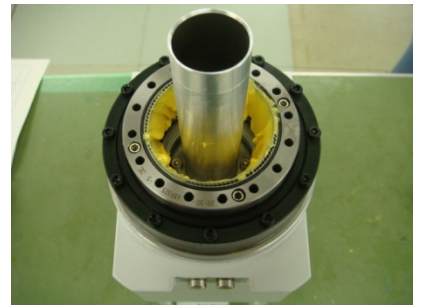

10. Remove the J4 sleeve holder.  
Then, remove the J4 sleeve.

Hexagon socket head cap bolts: 4-M3×6

The J4 sleeve is attached by gasket and may not be removed easily.  
If the part cannot be removed, pull the sleeve while rotating it.

Handle the sleeve with care since it is thin and easy to deform.

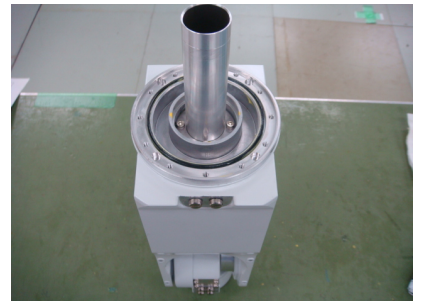

11. Remove the bolts of the bearing holder on the pulley.

Hexagon socket head cap bolts: 3-M3×8 (with a plain washer)

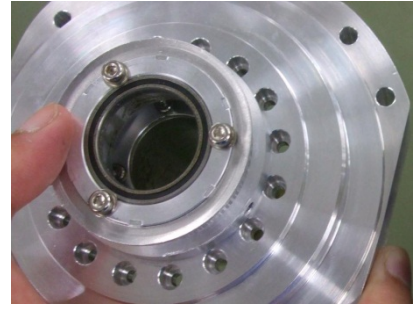

12. Remove the pulley from the pulley spacer.

Hexagon socket set screws: 2-M4×4

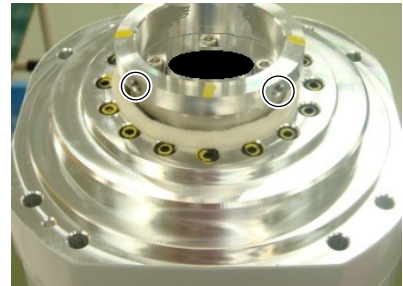

13. Remove the pulley spacer from the wave generator.

Hexagon socket head cap bolts: 4-M3×8

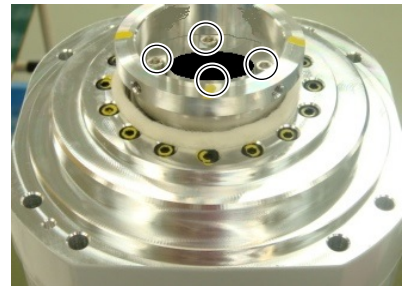



## Installation: Joint #4 Reduction gear unit

1. Apply grease to the mating surface of the sleeve and the fixing bolts.  
(for grease leakage prevention for the reduction gear unit)

Fit the J4 sleeve and install the J4 sleeve holder.

Hexagon socket head cap bolts: 4-M3×6

Tightening torque:  $2.0 \pm 0.1 \text{ N}\cdot\text{m}$

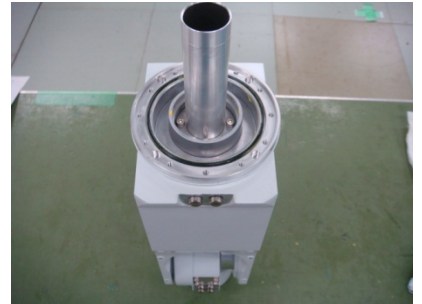
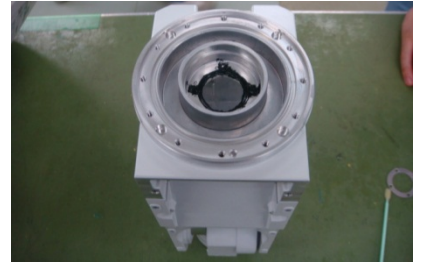

2. Install the O-ring to the O-ring groove.  
Install the Joint #4 reduction gear unit.

Hexagon socket head cap bolts: 12-M3×28

Tightening torque:  $2.4 \pm 0.1 \text{ N}\cdot\text{m}$

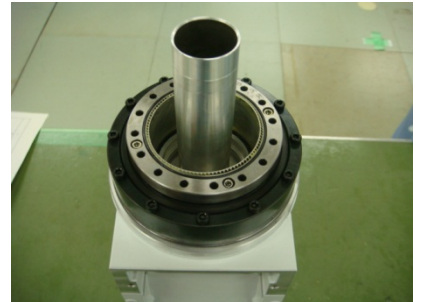

3. Apply grease to the Joint #4 reduction gear unit.

Grease: SK-1A

Grease amount: 20 g

Apply 10g of grease to the wave generator.

Apply the remaining 10 g to the inner side of the flexspline as shown in the photo.

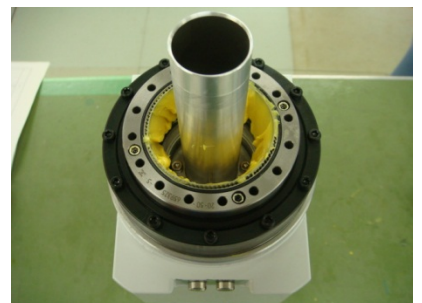
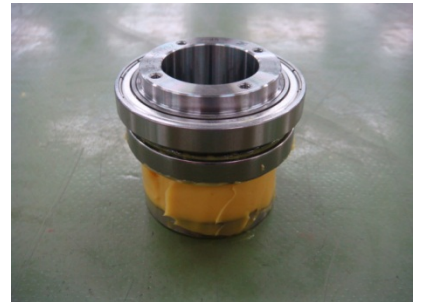

4. Install the wave generator of the Joint #4 reduction gear unit.

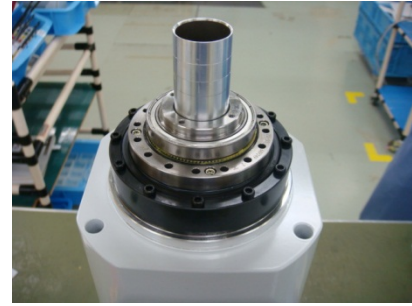

5. Set the O-ring attached to the reduction gear unit to the O-ring groove on the Joint #4 reduction gear unit. Then, install the J4 flange.

Hexagon socket head cap bolts: 16-M3×20

Tightening torque:  $2.4 \pm 0.1$  N·m

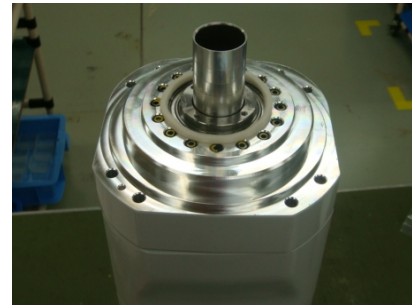
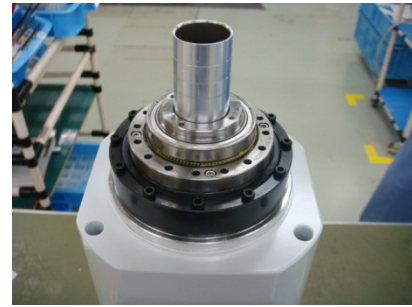

6. Fix the pulley spacer to the wave generator of the Joint #4 reduction gear unit.

Hexagon socket head cap bolts: 4-M3×8

Tightening torque:  $2.0 \pm 0.1$  N·m

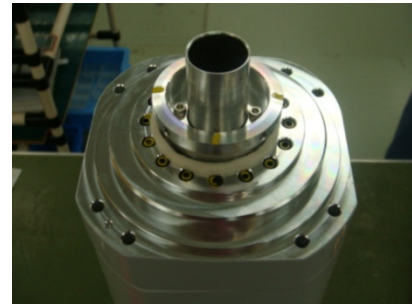

7. Fix the J4 pulley to the J4 pulley spacer.

Hexagon socket set screws: 2-M4×4

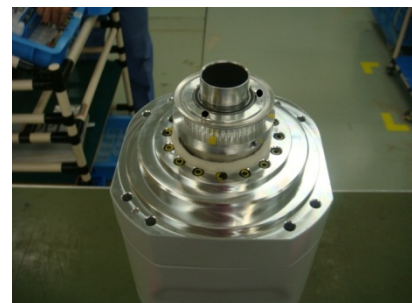

8. Apply adhesive to the following parts of the J4 pulley.

- Bearing mating part
- Inner ring (J4 sleeve)
- Outer ring (J4 pulley)

Adhesive: Loctite 641

Install the J4 pulley bearing, and tighten the bearing bolt.

Hexagon socket head cap bolts: 3-M3×8 (with a plain washer)

Tightening torque:  $2.0 \pm 0.1$  N·m

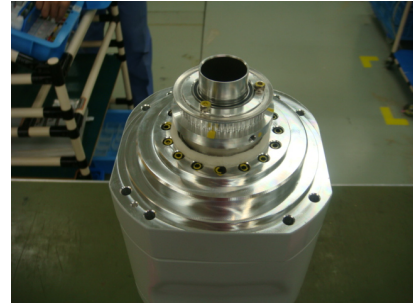

9. Install the Arm #4 to the Arm #3.

To fix all bolts, change the position of the Joint #4 by rotating it.

Hexagon socket head cap bolts: 8-M5×30

Tightening torque:  $10.0 \pm 0.5$  N·m

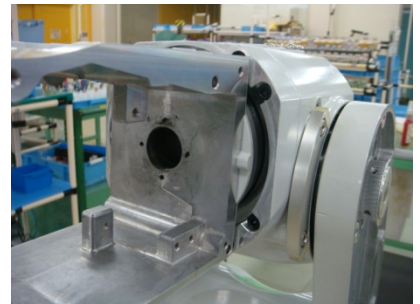

10. Install the Joint #4 timing belt with a proper tension.

For details, refer to *Maintenance 8.1 Joint #4 – Replacing the Motor*, Installation steps (5) and (6).



11. Pass the cables to the Arm #4.

For details, refer to Installation steps in *Maintenance 4.1 Cable Unit*.

12. Install the Joint #5 and #6 motors.

For details, refer to Installation steps of *Maintenance 9.1 Joint #5 – Replacing the Motor* and *Maintenance 10.1 Joint #6 – Replacing the Motor*.

13. Install the removed covers.

For details, refer to *Maintenance 3. Covers*.

14. Perform the calibration.

For details, refer to *Maintenance 16. Calibration*.

### 8.3 Joint #4 - Replacing the Timing Belt

	Name		Qty.	Note
Maintenance Parts	Timing belt (Joint #4)		1	1655931
	Belt tensile jig		1	1674582
Tools	Hexagonal wrench	width across flats: 2.5 mm	1	For M3 hexagon socket head cap bolt
		width across flats: 3 mm	1	For M4 hexagon socket head cap bolt
	Cross-point screwdriver (#2)		1	For cross recessed head screws
	Belt tension meter		1	Refer: Unitta U-505
	Nippers		1	For cutting the wire tie
	Masking tape		1	For protecting the connector clips
	Wire tie (AB100 or equivalent)		As needed	For passing the cables
	Braid tube (600 mm or longer)		1	For passing the cables

\* The belt tensile jig is an assembly jig. Use the jig when adjusting belt tension.

The brake is mounted on each joint to prevent the arm from lowering due to its own weight while the Controller power is OFF or the motor is OFF status. The brake does not work during replacement. Be careful when performing maintenance work.

#### Removal: Joint #4 Timing belt

1. Remove the Joint #4 motor unit.  
For details, refer to *Maintenance: 8.1 Joint #4 – Replacing the Motor*, Installation steps (1) through (6).

2. Remove the connectors inside the Arm #3 and the air tube (transparent).

Connectors:

X71, X72, X041,  
BR041, BR051, PS,  
BT4, BT51, X141, X151, X161

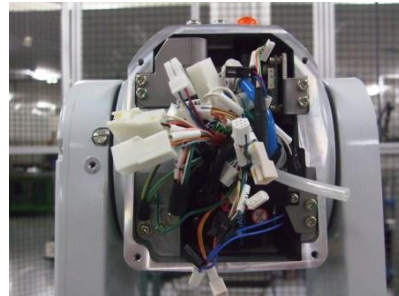

3. Remove the cable bracket inside the Arm #3.  
Hexagon socket head cap bolts: 4-M4×10

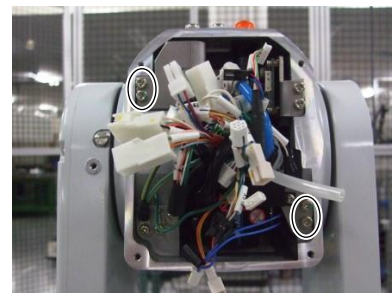



4. Remove the Arm #3 cable bracket and cable protection sheet.  
Hexagon socket head cap bolts: 2-M3×6

The Arm #3 cable bracket and cable protection sheet will be used again. Be careful not to lose them.

5. Remove the Arm #4 side cover.  
For details, refer to *Maintenance: 3 Covers*.



6. Remove the cable protection plate attached to the Arm #4.  
Hexagon socket head cap bolts: 2-M4×10

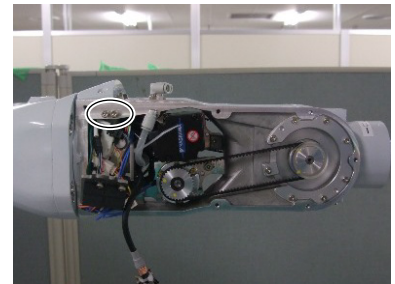

7. Remove the green/yellow ground wire and the green ground wire connected to X052 and X062 from the cable protection plate.  
Cross recessed head screws with captive washer: 2-M4×8  
Positions of the ground wire terminals may differ from the photo. Check which connector the terminal is connected to.

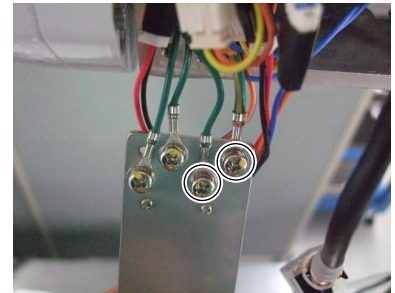

8. Remove the following connectors.  
Connector: X052, X062

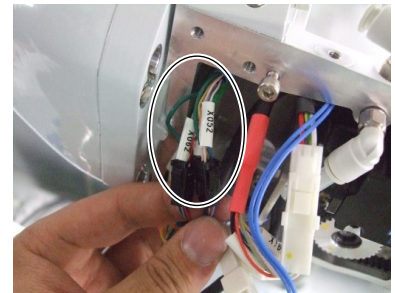

9. Remove the Arm #4 cable bracket and the cable protection sheet.  
Hexagon socket head cap bolts: 2-M3×6

The Arm #4 cable bracket and cable protection sheet will be used again. Be careful not to lose them.

C8XL:

The cable protection tube is used instead of the cable protection sheet.

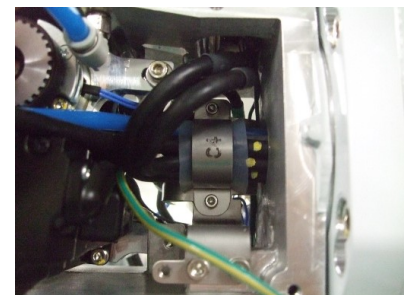

10. Remove the air tube (blue) from the fitting.

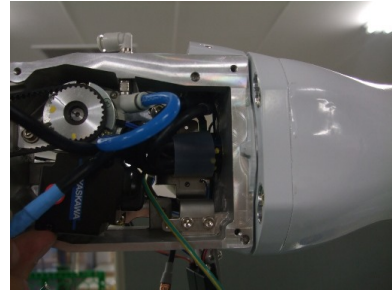

C8XL:

11. Remove the Arm #4 maintenance cover.  
For details, refer to *Maintenance: 3 Covers*.

C8XL:

12. Remove the Arm #4 cable bracket and the cable protection sheet.

Hexagon socket head cap bolts: 2-M3×6

The Arm #4 cable bracket and cable protection sheet will be used again. Be careful not to lose them.



13. Pull the following parts from the Arm #4 to the Arm #3.

- LAN cable
- X052 and X062 cables
- Ground wire
- Air tube (blue)

Protect the connectors with masking tapes.

- To protect the connector's clips
- To avoid adherence of cable grease

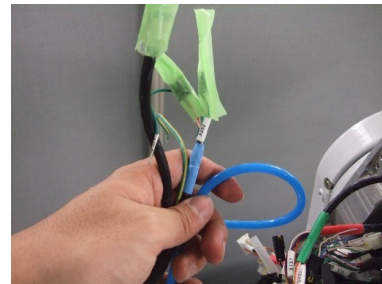

14. Remove the Joint #4 timing belt.

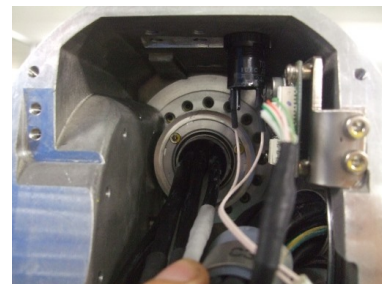

## Installation: Joint #4 Timing belt

1. Pass the Joint #4 timing belt around the Joint #4 pulley 2

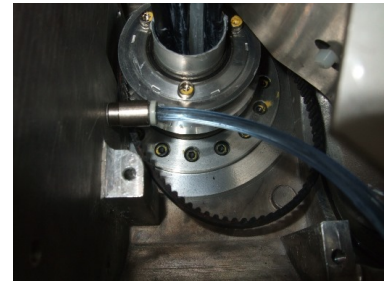

2. Install the Joint #4 motor unit.

For details, refer to *Maintenance: 8.1 Joint #4 – Replacing the Motor*, Installation steps (4) through (6).

3. Pass the following parts from the Arm #3 to the Arm #4.
  - X052 and X062 cables
  - LAN cable
  - Ground wire
  - Air tube (blue)



How to pass the cables:

First pass the braid tube from the Arm #4 side to the Arm #3 side. Insert the connectors through the braid tube, as shown in the photo, and fix the tube with the wire tie so that connectors are not to be pulled out. Then, pull the braid tube from the Arm #4 side while pushing the cables from the Arm #3 side to pass the cables through. (See the photo.)



**NOTE** Pulling the cables forcibly may cause falling off or breakage of the connectors and disconnection of the cables.

If it is difficult to pass the cables, pass the cables one by one in the following order.

X052 and X062 cables LAN cable Ground wire Air tube (blue)

C8XL:

4. Wrap the cables inside the Arm #4 extension part with a cable protection sheet and install the Arm #4 cable bracket.

Hexagon socket head cap bolts: 2-M3×6

Tightening torque:  $2.0 \pm 0.1$  N·m

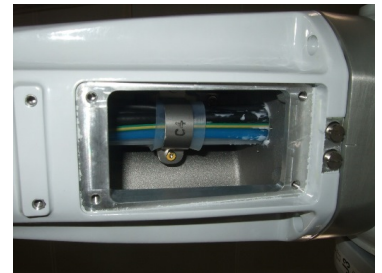

5. Wrap the cables inside the Arm #4 with a cable protection sheet and install the Arm #4 cable bracket.

C8XL:

Install the Arm #4 cable bracket on the cable protection tube.

Hexagon socket head cap bolts: 2-M3×6

Tightening torque:  $2.0 \pm 0.1$  N·m

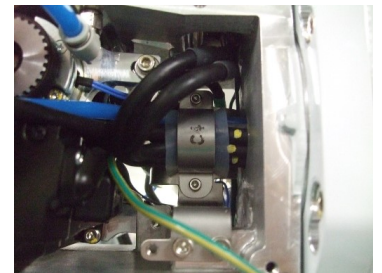

6. Wrap the cables inside the Arm #3 with a cable protection sheet and install the Arm #3 cable bracket.

Hexagon socket head cap bolts: 2-M3×6

Tightening torque:  $2.0 \pm 0.1$  N·m



7. Install the cable bracket inside the Arm #3.

Hexagon socket head cap bolts: 4-M4×10

Tightening torque:  $4.0 \pm 0.2$  N·m

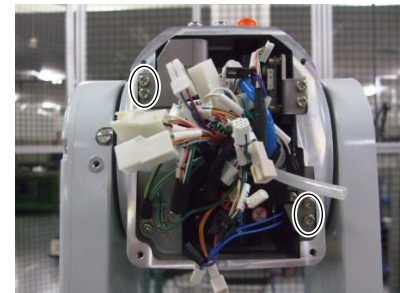

8. Install the brake power supply to the plate.  
Install the brake power supply so that the cable is facing to the left.

Cross recessed head screws with captive washer: 2-M3×6

Tightening torque:  $0.45 \pm 0.1$  N·m

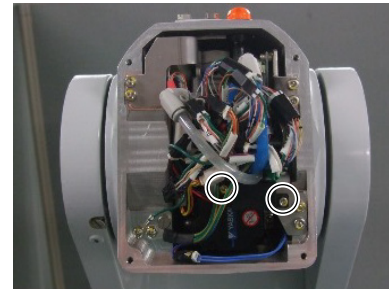

9. Connect the connectors inside the Arm #3 and the air tube (transparent).

Connector:

X71, X72, X041,

BR041, BR051, PS,

BT4, BT51, X141, X151, X161

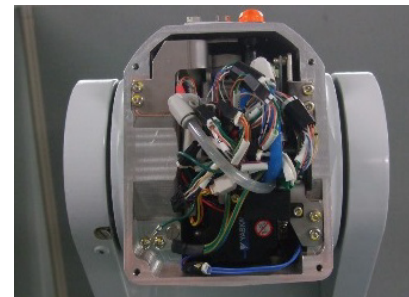

10. Connect the ground wire terminals inside the Arm #4 to the Arm #4 cable protection bracket.

Cross recessed head screws with captive washer: 2-M4×8

Tightening torque:  $0.45 \pm 0.1$  N·m

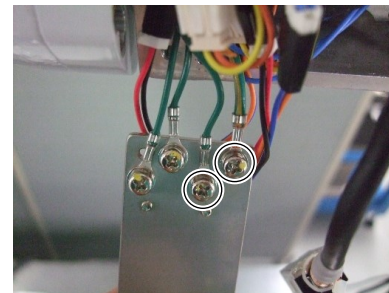



11. Connect the connectors inside the Arm #4.

Connector:

X052, X062

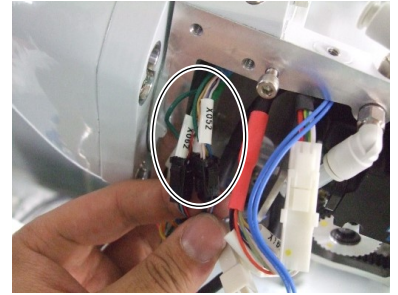

12. Fix the cable protection bracket to the Arm #4.

Hexagon socket head cap bolts: 2-M4×10

Tightening torque:  $4.0 \pm 0.2 \text{ N}\cdot\text{m}$

**NOTE** Be careful not to get the cables caught.

 It may cause cable breakage.

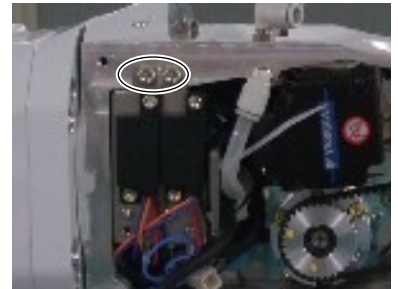

13. Install the air tube (blue) to the fitting.

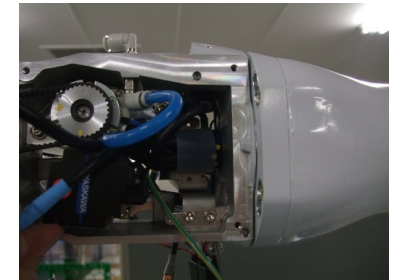

14. Install the following covers.

Arm #3 cover

Arm #3 maintenance cover

Arm #4 side cover

Arm #4 maintenance cover : C8XL only

For details, refer to *Maintenance 3. Covers*.

### 8.4 Joint #4 - Replacing the Electromagnetic Brake

	Name	Qty.	Note	
Maintenance Parts	Electromagnetic brake	1	2172928 (common for Joints #4, #5, #6)	
	Belt tensile jig	1	1674582	
Tools	Hexagonal wrench	width across flats: 2 mm	1	For M4 hexagon socket set screws
		width across flats: 2.5 mm	1	For M3 hexagon socket head cap bolts
		width across flats: 3 mm	1	For M4 hexagon socket head cap bolts
	Cross-point screwdriver (#2)	1	For cross recessed head screws	
	Feeler gauge (0.5 mm)	1	For adjusting the drive boss position	
Belt tension meter	1	Refer: Unitta U-505		

\* The belt tensile jig is an assembly jig. Use the jig when adjusting belt tension.

The brake is mounted on each joint to prevent the arm from lowering due to its own weight while the Controller power is OFF or the motor is OFF status. The brake does not work during replacement. Be careful when performing maintenance work.

**NOTE**  The electromagnetic brakes are common for Joints #4, #5, and #6. The Joints #5 and #6 electromagnetic brakes have an identification label for preventing misconnection of the connectors. The label is not necessary for the Joint #4 electromagnetic brake. (There is no connector identification label for the Joint #4.)

#### Removal: Joint #4 Electromagnetic brake

1. Remove the Joint #4 electromagnetic brake.  
For details, refer to *Maintenance: 8.1 Joint #4 – Replacing the Motor*, Removal steps (1) through (8).

#### Installation: Joint #4 Electromagnetic brake

1. Mount the Joint #4 electromagnetic brake to the Joint #4 motor unit.  
For details, refer to *Maintenance: 8.1 Joint #4 – Replacing the Motor*, Installation steps (2) through (11).

## 9. Joint #5



- Do not connect or disconnect the motor connectors while the power to the robot system is turned ON. Connecting or disconnecting the motor connectors with the power ON is extremely hazardous and may result in serious bodily injury as the Manipulator may move abnormally, and also may result in electric shock and/or malfunction of the robot system.
- To shut off power to the robot system, disconnect the power plug from the power source. Be sure to connect the AC power cable to a power receptacle. DO NOT connect it directly to a factory power source.
- Before performing any replacement procedure, turn OFF the Controller and related equipment, and then disconnect the power plug from the power source. Performing any replacement procedure with the power ON is extremely hazardous and may result in electric shock and/or malfunction of the robot system.



- Be careful not to apply excessive shock to the motor shaft during replacement. The shock may shorten the life of the motors and encoder and/or damage them.
- Never disassemble the motor and the encoder. Disassembled motor and encoder will cause a positional gap and cannot be used again.

After parts have been replaced (motors, reduction gear units, electromagnetic brakes, timing belts, etc.), the Manipulator cannot perform positioning properly because a gap exists between the origin stored in each motor encoder and its corresponding origin stored in the Controller.

Therefore, it is necessary to match these origins after replacing the parts.

The process of aligning the two origins is called “Calibration”.

Refer to *Maintenance 16. Calibration* and perform the calibration after the parts replacement.

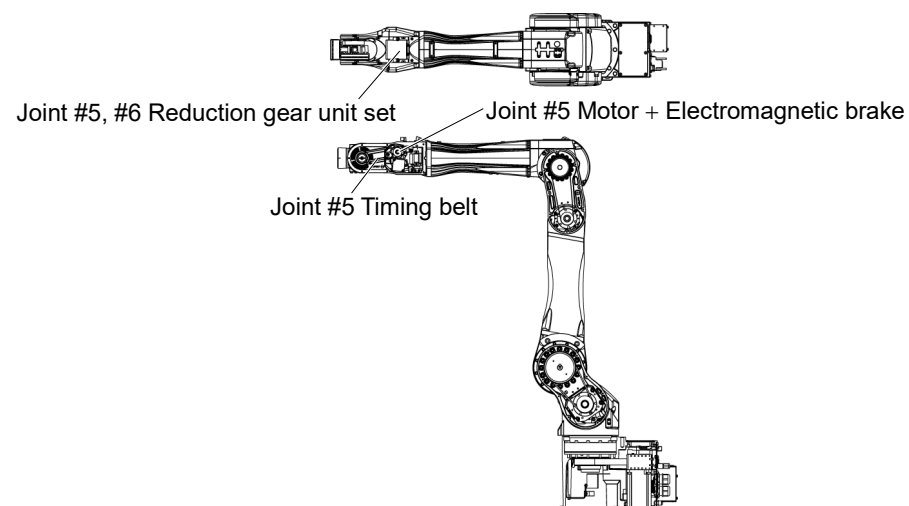

(Figure: C8-A1401\* (C8XL))

### 9.1 Joint #5 - Replacing the Motor

	Name	Qty.	Note	
Maintenance Parts	AC servo motor 100 W	1	2172051 (Common for Joints #4, #5, #6)	
	Belt tensile jig *	1	1674582	
Tools	Hexagonal wrench	width across flats: 2 mm	1	For M4 hexagon socket set screws
		width across flats: 2.5 mm	1	For M3 hexagon socket head cap bolts
		width across flats: 3 mm	1	For M4 hexagon socket head cap bolts
	Cross-point screwdriver (#2)	1	For cross recessed head screws	
	Torque wrench	1	For tightening torque control	
	Spanner (width across flats: 8 mm)	1	For air tube fitting	
	Feeler gauge (0.5 mm)	2	For adjusting the drive boss position	
Belt tension meter	1	Refer: Unitta U-505		

\* The belt tensile jig is an assembly jig. Use the jig when adjusting belt tension.

The brake is mounted on each joint to prevent the arm from lowering due to its own weight while the Controller power is OFF or the motor is OFF status. The brake does not work during replacement. Be careful when performing maintenance work.

#### Attaching the labels

The motors are common for Joints #4, #5, and #6.

In order to prevent misconnection of the connectors, attach the label for the motor as shown in the photos.

Joint #5 motor Locations of the connector labels



X152



X052



BT52



\_.BT52

## Removal: Joint #5 Motor

1. Turn OFF the Controller power.
2. Remove the Arm #4 side cover.  
For details, refer to *Maintenance: 3. Covers*.
3. Loosen the screws fixing the cable protection bracket on the Arm #4 and pull out the cables.

Hexagon socket head cap bolts: 2-M4×10

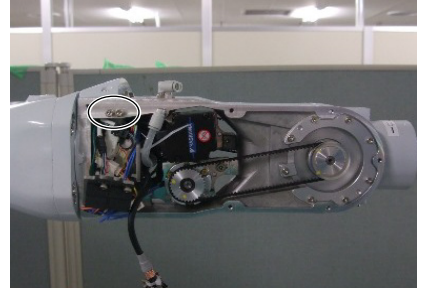

4. Remove the brake power supply connected to the connector (BR052) from the plate.

Cross recessed head screw with captive washer: 2-M3×6

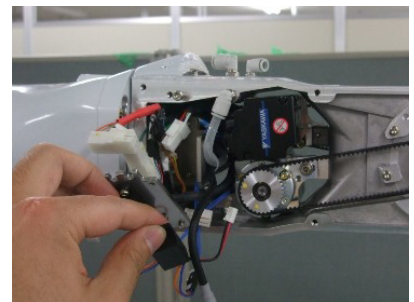

5. Disconnect the following connectors.

Connector: X052, X152, BT52, BR052

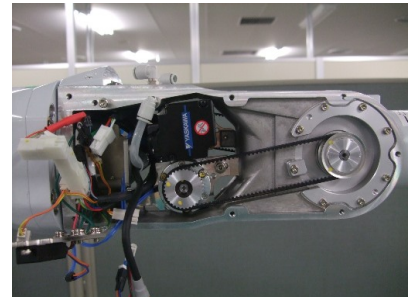

6. Remove the air tube fitting located in the front of the Joint #5 motor unit.

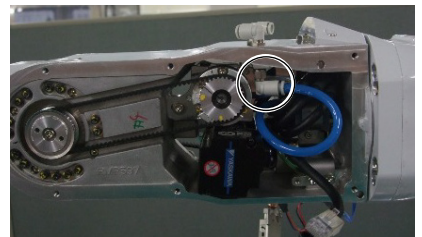

- Loosen the screws fixing the Joint #5 motor unit and remove the belt.

Hexagon socket head cap bolts:  
2-M4×15 (with a plain washer)

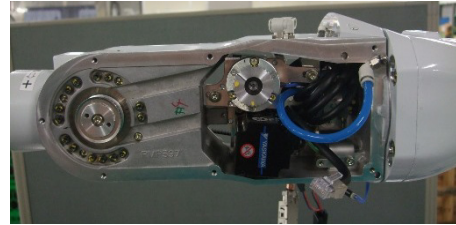
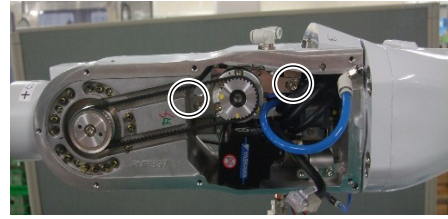

- Remove the Joint #5 motor unit.

Hexagon socket head cap bolts:  
2-M4×15 (with a plain washer)

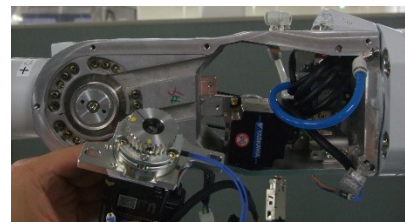

- Remove the Joint #5 pulley 1 and the drive boss from the motor shaft of the Joint #5 motor unit.

Pulley 1 and drive boss screws  
Hexagon socket set screws: 2-M4×4 (with a brass bushing)

Drive boss and motor shaft screws  
Hexagon socket set screws: 2-M4×4

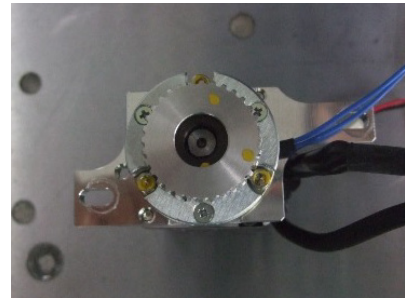

There is a brass bushing on one of the set screws fixing the drive boss and the pulley. Be careful not to lose it.

- A: Pulley and motor shaft screws
- B: Pulley and drive boss screws
- C: Bushing

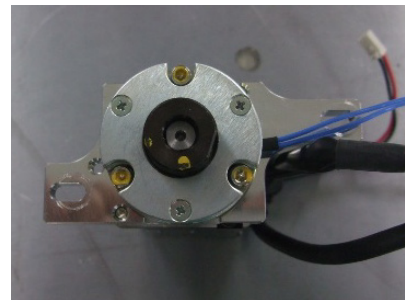
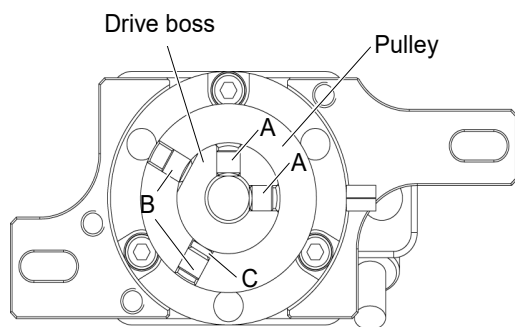



10. Remove the Joint #5 electromagnetic brake.

Hexagon socket head cap bolts: 3-M3×15 (with a spacer)

Be careful not to lose the spacers.

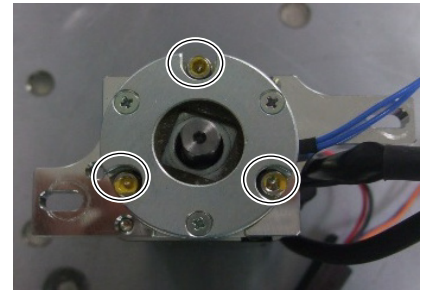

11. Remove the motor plate from the Joint #5 motor.

Hexagon socket head cap bolts: 2-M4×10

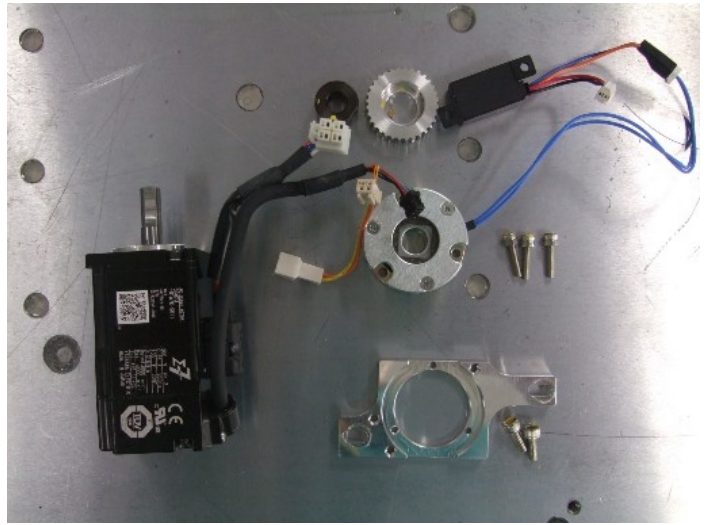
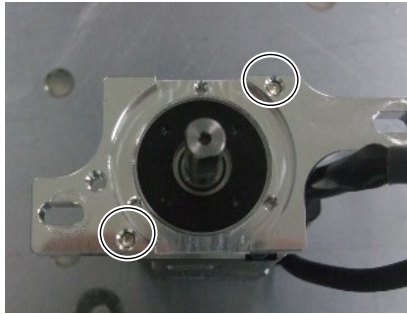



Installation: Joint #5 Motor

1. Install the motor plate to the Joint #5 motor.

Hexagon socket head cap bolts: 2-M4×10

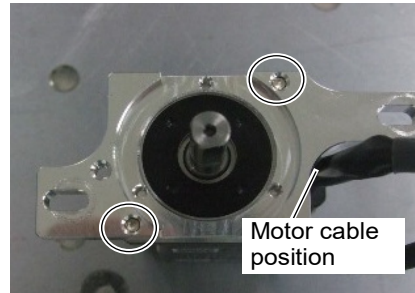
Tightening torque:  $4.0 \pm 0.2 \text{ N}\cdot\text{m}$





**NOTE** Be careful of the assembly direction of the motor plate.  
 (See the photo.)

2. Mount the Joint #5 electromagnetic brake to the Joint #5 motor unit. Insert the spacers between the hexagon socket set screws and the Joint #5 electromagnetic brake.

Hexagon socket set screws: 3-M2.5×10 (with a spacer)

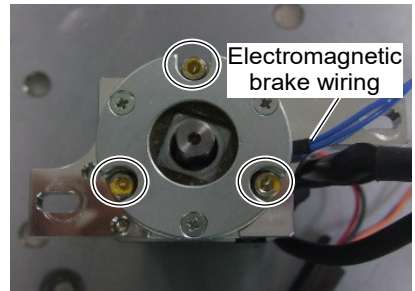
Tightening torque:  $2.0 \pm 0.1 \text{ N}\cdot\text{m}$



**NOTE** Be careful of the assembly direction of the Joint #5 electromagnetic brake wiring.  
 (See the photo.)

3. Mount the drive boss and the pulley 1 to the Joint #5 motor unit.

Fix the drive boss and the motor shaft.

There is an uneven part for the feeler gauge (0.5 mm) on the boss.

Use the uneven part to leave 0.5 mm space.



**NOTE** If there is no space, the parts may chafe while the motor is driving and it may result in breakage while the motor is moving.  



Set the set screws to the positions indicated in the figure.

A: Pulley and motor shaft screws

B: Pulley and drive boss screws

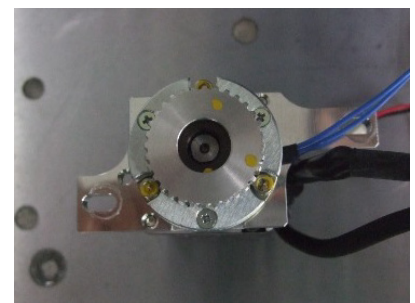
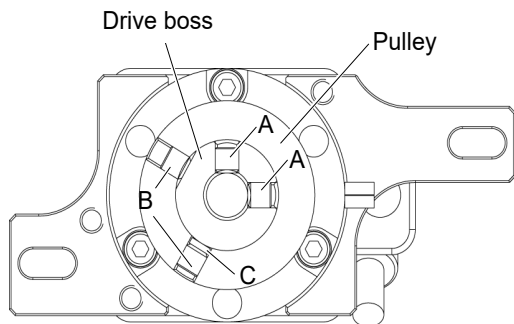
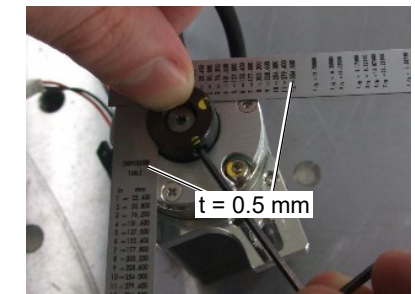
C: Bushing



**NOTE** If the screw positions are incorrect or the bushing is not set, it may cause damage on the side of the part and may result in the part being unable to be removed.  



Drive boss and the motor shaft:

Hexagon socket set screws: 2-M4×4

Tightening torque:  $2.5 \pm 0.2 \text{ N}\cdot\text{m}$

Align the screws to the two flat faces of the motor shaft and fix them.

Drive boss and the pulley 1:

Hexagon socket set screws: 2-M4×4 (with a brass bushing)

Tightening torque:  $2.5 \pm 0.2 \text{ N}\cdot\text{m}$

Fix the set screws while pressing the pulley 1 to the drive boss.

The brass bushing is not necessary for the screw for the flat surface (D-cut). Set the bushing to the other screw and then fix the screw.

- Put the Joint #5 motor unit inside the Arm #4.

Pass the cables of the Joint #5 motor unit to the Joint #6 motor unit side so that the cables can be stored in the storage space.

(See the photo)

- Pass the timing belt around the pulley 1 and pulley 2 and fix it temporarily.

Make sure that the teeth of the timing belt engage with these of the pulley.

As a rough guide of temporary fixing, check that the motor unit can be moved by hand, and it does not tilt when being pulled.

If the belt is too loose or too tight, it will not have proper tension

- Apply tension to the Joint #5 timing belt and fix the Joint #5 motor unit.

Joint #5 Timing belt tension: 15 to 30 N

Bet tension meter setting value

Weight:  $2.5 \text{ g/mm width} \times \text{m span}$ , Width: 6 mm, Span: 117 mm

Hexagon socket head cap bolts: 2-M4×15 (with a plain washer)

Tightening torque:  $4.0 \pm 0.2 \text{ N}\cdot\text{m}$



Regarding belt tension:

- Jumping (position gap) may occur if the value is below the lower limit.
- Vibration (abnormal noise) or reduction in life of the parts may occur if the value exceeds the upper limit.
- When you replace with a new belt, belt extends and the belt tension may decrease in the initial stage. Make sure to operate the robot two to three days and check the belt tension again.

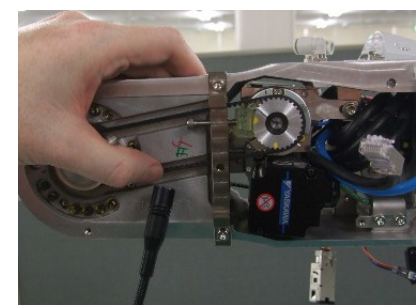
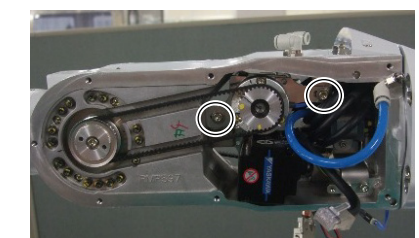
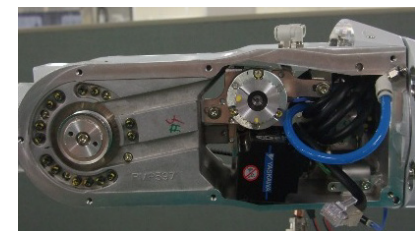
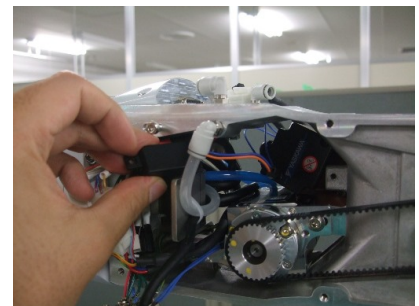

When using the belt tension tensile jig (maintenance part):

Fix the belt tension tensile jig (for J4, J5, and J6) with the screws (2-M4×15) and push the rubber against the pulley.

Tension is applied as the set screw (M6×15) is pushed by the rubber.

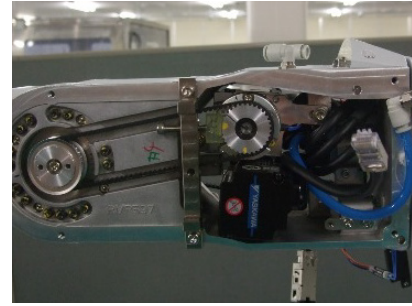

7. Install the air tube fitting in the front of the Joint #5 motor unit.  
After tightening by hand, tighten one sixth to quarter of a turn.

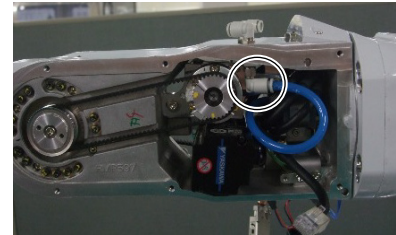

NOTE Tightening of the fitting:



Fitting is too tight:

It may cause air leakage due to screw breakage or gasket deformation.

Fitting is too loose:

It may cause loose screws and air leakage.

8. Connect the following connectors.

Connectors: X052, X152, BT52, BR052

9. Install the brake power supply to the plate.

Cross recessed head screw with captive washer: 2-M3×6

Tightening torque:  $0.45 \pm 0.1$  N·m

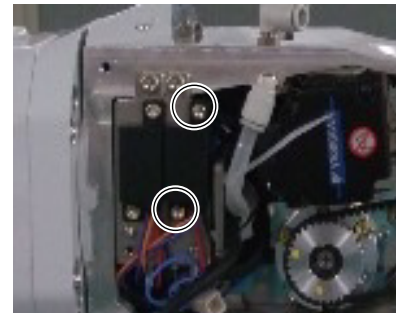

10. Fix the cable protection bracket to the Arm #4.

Hexagon socket head cap bolts: 2-M4×10

Tightening torque:  $4.0 \pm 0.2$  N·m

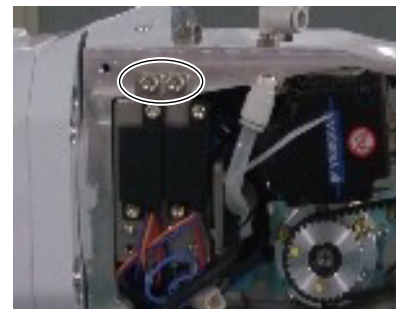

NOTE Be careful not to get the cables caught. It may result in cable breakage.



11. Install the Arm #4 side cover.  
For details, refer to *Maintenance: 3. Covers*.
12. Perform the calibration.  
For details, refer to *Maintenance: 16. Calibration*.

## 9.2 Joint #5 - Replacing the Reduction Gear Unit (Replacing the Joint #5, #6 Reduction Gear Unit Set)

For replacement of the Joint #5 and Joint #6 reduction gear unit, replace the Joints #5, #6 reduction gear unit set.

The Joints #5 and #6 reduction gear unit set is adjusted in advance.

	Name	Qty.	Note	
Maintenance Parts	Joints #5, #6 Reduction gear unit set	1	1674610 (common to C8 series)	
	Belt tensile jig*	1	1674582	
Tools	Hexagonal wrench	width across flats: 2 mm	1	For M4 hexagon socket set screws
		width across flats: 2.5 mm	1	For M3 hexagon socket head cap bolts
		width across flats: 3 mm	1	For M4 hexagon socket head cap bolts
		width across flats: 4 mm	1	For M5 hexagon socket head cap bolts
		width across flats: 5 mm	1	For M6 hexagon socket head cap bolts
	Cross-point screwdriver (#2)	1	For cross recessed head screws	
	Torque wrench	1	For tightening torque control	
	Spanner ( width across flats: 8 mm)	1	For air fittings	
	Feeler gauge (0.5 mm)	2	For drive boss position adjustment	
Belt tension meter	1	Refer: Unitta U-505		

The brake is mounted on each joint to prevent the arm from lowering due to its own weight while the Controller power is OFF or the motor is OFF status. The brake does not work during replacement. Be careful when performing maintenance work.

Removal: Joints #5, #6 Reduction gear unit set

1. Turn OFF the Controller power.
2. Remove the Arm #4 side cover and Arm #3 cover.

For details, refer to *Maintenance 3. Covers*.

3. Remove the Joints #5 and #6 motors.

For details, refer to the Removal steps in *Maintenance 9.1 Joint #5 - Replacing the Motor* and *Maintenance 10.1 Joint #6 - Replacing the Motor*.

4. Remove the cables passing through the Arm #4 as shown in the photo.

For details, refer to the Removal steps in *Maintenance 4.1 Cable Unit*.



5. Remove the Joints #5, #6 reduction gear unit.

C8:

Loosen the fixing bolts of the Joint #4 motor plate and remove the belt. (Do not remove the Joint #4 motor.)

Hexagon socket head cap bolts: 2-M4×15  
(with a small plain washer)

Remove the bolts fixing the J4 flange, and remove the Joints #5 and #6 reduction gear unit (with the Joint #4 reduction gear unit) from the Arm #3.

Hexagon socket head cap bolts: 8-M5×30

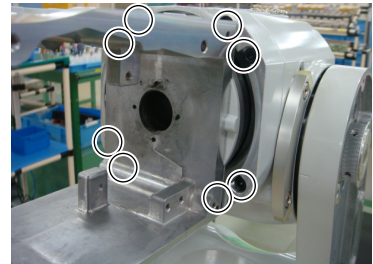
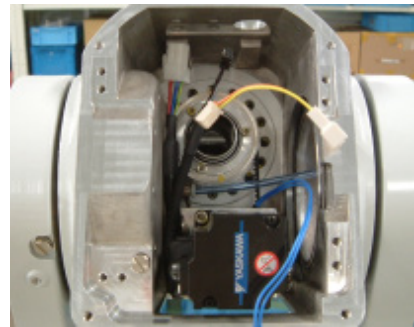

C8L, C8XL:

Remove the bolts fixing the Arm #4 extension flange, and remove the Joints #5 and #6 reduction gear unit from the Arm #4 extension part.

Hexagon socket head cap bolts: 4-M6×20

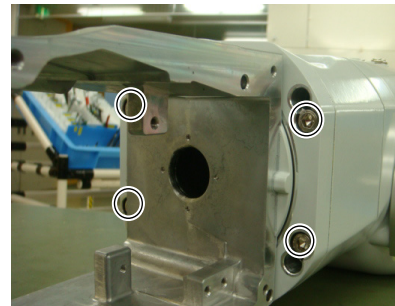

6. Follow the following steps according to the model.

C8: Remove the Joint #4 reduction gear unit.

For details, refer to Removal steps in *Maintenance 8.2 Joint #4 – Replacing the Reduction Gear Unit*.

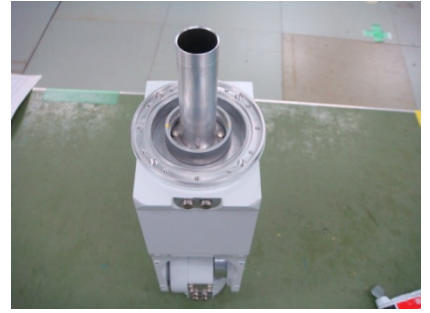

C8L, C8XL:

Remove the Arm #4 extension flange.

C8XL does not have the J4 sleeve on the Arm #4.

Hexagon socket head cap bolts: 12-M3×18



7. C8, C8L:

First, remove the J4 sleeve holder.

Then, remove the J4 sleeve.

Hexagon socket head cap bolts: 4-M3×6

The J4 sleeve is adhered with gasket and may not be removed easily.

If the part cannot be removed, pull the sleeve while rotating it.

Handle the sleeve with care since it is thin and easy to deform.

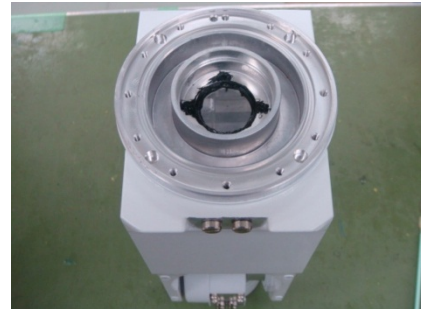



Installation: Joints #5, #6 Reduction gear unit set

1. C8, C8L:

Apply grease to the mating part of the sleeve and the fixing bolts.  
(for grease leakage prevention for the reduction gear unit)  
Fit the J4 sleeve and install the J4 sleeve holder.

Hexagon socket head cap bolts: 4-M3×6

Tightening torque:  $2.0 \pm 0.1$  N·m



2. C8:

Install the Joint #4 reduction gear unit.  
For details, refer to Installation steps in *Maintenance 8.2 Joint #4 – Replacing the Reduction Gear Unit.*



C8L, C8XL:

Install the Arm #4 extension flange.  
(C8XL does not have the sleeve.)

Hexagon socket head cap bolts: 12-M3×18

Tightening torque:  $2.4 \pm 0.1$  N·m

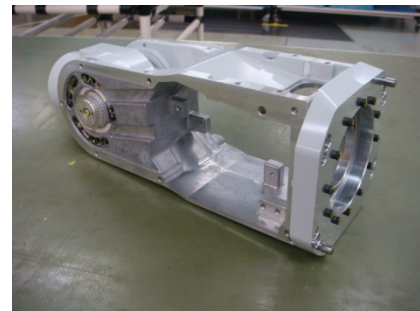

3. Install the Joints #5 and #6 reduction gear unit.

C8:

Install the J4 flange to the Arm #3.

Hexagon socket head cap bolts: 8-M5×30

Tightening torque:  $10.0 \pm 0.5$  N·m

Apply proper tension to the Joint #4 timing belt and fix the Joint #4 motor unit.

For details, refer to *Maintenance 8.1 Joint #4 – Replacing the Motor*, Installation steps (6).



C8L,C8XL:

Install the Arm #4 extension flange to the Arm #4 extension part.

C8L:

Apply adhesive to the J4 sleeve and the J4 pulley bearing mating part (indicated by a yellow mark in the right photo)

Adhesive: Loctite641

Hexagon socket head cap bolts: 4-M6×20

Tightening torque:  $13.0 \pm 0.6 \text{ N}\cdot\text{m}$

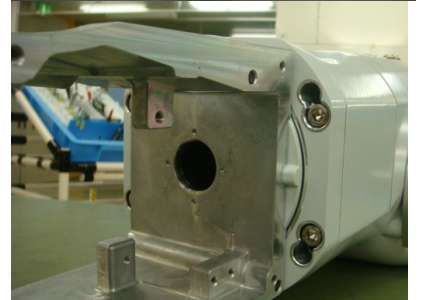

4. Pass the cables to the Arm #4.

Connect all the connectors inside the Arm #3 and bind them together.



Fix the cables inside the Arm #4, and connect the D-sub to the Arm #4.

For details, refer to Installation steps in *Maintenance 4.1 Cable Unit*.



5. Install the Joints #5 and #6 motors.

For details, refer to Installation steps in *Maintenance 9.1 Joint #5 – Replacing the Motor* and *Maintenance 10.1 Joint #6 – Replacing the Motor*.

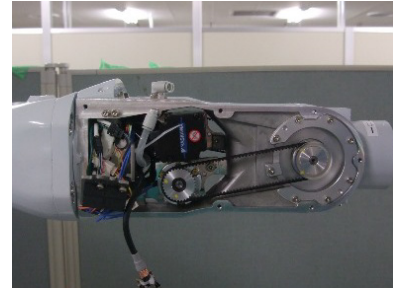
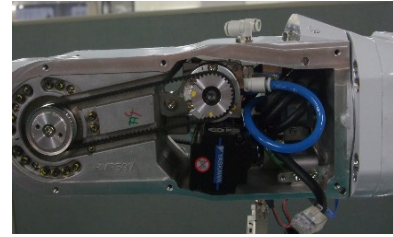

6. Install the removed covers.

For details, refer to *Maintenance 3. Covers*.

7. Perform the calibration.

For details, refer to *Maintenance 16. Calibration*.



### 9.3 Joint #5 - Replacing the Timing Belt

	Name		Qty.	Note
Maintenance Parts	Joint #5 timing belt	330 mm	1	1655932
	Belt tensile jig		1	1674582
Tools	Hexagonal wrench (width across flats: 3 mm)		1	For M4 hexagon socket head cap bolts
	Cross-point screwdriver (#2)		1	For cross recessed head screws
	Torque wrench		1	For tightening torque control
	Belt tension meter		1	Refer: Unitta U-505

\* The belt tensile jig is an assembly jig. Use the jig when adjusting belt tension.

The brake is mounted on each joint to prevent the arm from lowering due to its own weight while the Controller power is OFF or the motor is OFF status. The brake does not work during replacement. Be careful when performing maintenance work.

#### Removal: Joint #5 Timing belt

1. Turn OFF the Controller power.
2. Remove the Arm #4 side cover.  
For details, refer to *Maintenance: 3. Covers*.
3. Loosen the Joint #5 motor unit set screws.  
Hexagon socket head cap bolts: 2-M4×15  
(with a plain washer)

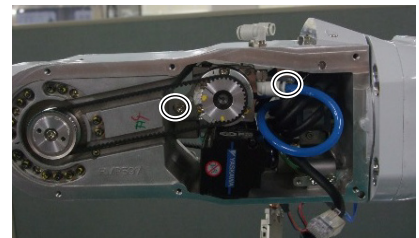

4. Remove the Joint #5 timing belt.

#### Installation: Joint #5 Timing belt.

1. Pass the Joint #5 timing belt around the pulley 1 and the pulley 2 of the Joint #5.
2. Secure the Joint #5 motor unit.  
For details, refer to *Maintenance: 9.1 Joint #5 – Replacing the Motor*, Installation steps (5) to (6) and (11) to (12).

**9.4 Joint #5 - Replacing the Electromagnetic Brake**

	Name	Qty.	Note	
Maintenance Parts	Electromagnetic brake	1	2172928 (Common for Joints #4, #5, #6)	
	Belt tensile jig	1	1674582	
Tools	Hexagonal wrench	width across flats: 2 mm	1	For M4 hexagon socket set screws
		width across flats: 2.5 mm	1	For M3 hexagon socket head cap bolts
		width across flats: 3 mm	1	For M4 hexagon socket head cap bolts
	Cross-point screwdriver (#2)	1	For cross recessed head screws	
	Torque wrench	1	For tightening torque control	
	Spanner (width across flats: 8 mm)	1	For air tube fitting	
	Feeler gauge (0.5 mm)	1	For adjusting the pulley position	
Belt tension meter	1	Refer: Unitta U-505		

\* The belt tensile jig is an assembly jig. Use the jig when adjusting belt tension.

The brake is mounted on each joint to prevent the arm from lowering due to its own weight while the Controller power is OFF or the motor is OFF status. The brake does not work during replacement. Be careful when performing maintenance work.

**Attaching the labels**

The electromagnetic brakes are common for Joints #4, #5, and #6. In order to prevent misconnection of the connectors, attach the label for the electromagnetic brakes as shown in the photos.

Joint #5 electromagnetic brakes      Locations of the connector labels



BR052  
Cable (red/black)



BR053  
Cable (blue/blue)



BR053  
Cable (blue/orange)

**NOTE**  BR053 is connected at the time of shipment. Before attaching the label, disconnect the connector.

One side of BR052 and BR053 have the same shape. Identify the connectors by color.

**Removal: Joint #5 Electromagnetic brake**

1. Remove the Joint #5 electromagnetic brake.

For details, refer to *Maintenance: 9.1 Joint #5 – Replacing the Motor*, Removal steps (1) through (10).

**Installation: Joint #5 Electromagnetic brake**

1. Mount the Joint #5 electromagnetic brake to the Joint #5 motor unit.

For details, refer to *Maintenance: 9.1 Joint #5 – Replacing the Motor*, Installation steps (2) through (12).

## 10. Joint #6

 WARNING	<ul style="list-style-type: none"> <li>■ Do not connect or disconnect the motor connectors while the power to the robot system is turned ON. Connecting or disconnecting the motor connectors with the power ON is extremely hazardous and may result in serious bodily injury as the Manipulator may move abnormally, and also may result in electric shock and/or malfunction of the robot system.</li> <li>■ To shut off power to the robot system, disconnect the power plug from the power source. Be sure to connect the AC power cable to a power receptacle. DO NOT connect it directly to a factory power source.</li> <li>■ Before performing any replacement procedure, turn OFF the Controller and related equipment, and then disconnect the power plug from the power source. Performing any replacement procedure with the power ON is extremely hazardous and may result in electric shock and/or malfunction of the robot system.</li> </ul>
--	---

 CAUTION	<ul style="list-style-type: none"> <li>■ Be careful not to apply excessive shock to the motor shaft during replacement. The shock may shorten the life of the motors and encoder and/or damage them.</li> <li>■ Never disassemble the motor and the encoder. Disassembled motor and encoder will cause a positional gap and cannot be used again.</li> </ul>
--	--

After parts have been replaced (motors, reduction gear units, electromagnetic brakes, timing belts, etc.), the Manipulator cannot perform positioning properly because a gap exists between the origin stored in each motor encoder and its corresponding origin stored in the Controller.

Therefore, it is necessary to match these origins after replacing the parts.

The process of aligning the two origins is called “Calibration”.

Refer to *Maintenance 16. Calibration* and perform the calibration after the parts replacement.

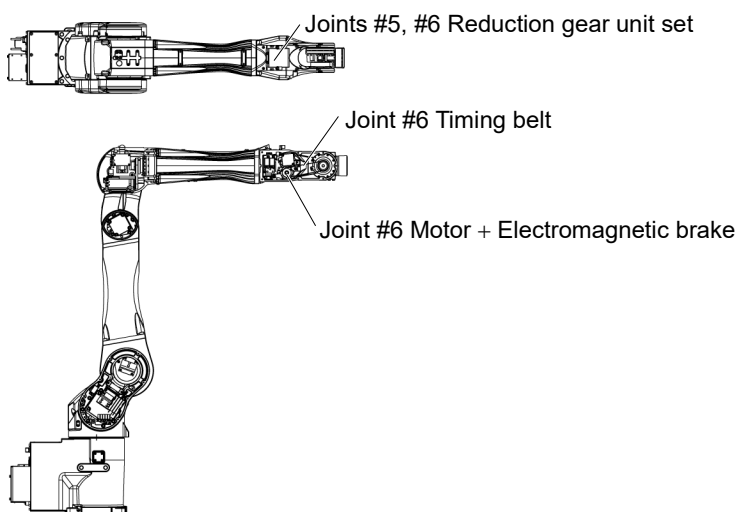

(Figure: C8-A1401\* (C8XL))

## 10.1 Joint #6 - Replacing the Motor

	Name	Qty.	Note	
Maintenance Parts	AC servo motor 100 W	1	2172051 (common to Joints #4, #5, #6)	
	Belt tensile jig *	1	1674582	
Tools	Hexagonal wrench	width across flats: 2 mm	1	For M4 hexagon socket set screws
		width across flats: 2.5 mm	1	For M3 hexagon socket head cap bolts
		width across flats: 3 mm	1	For M4 hexagon socket head cap bolts
	Cross-point screwdriver (#2)	1	For cross recessed head screws	
	Feeler gauge (0.5 mm)	2	For adjusting the drive boss position	
Belt tension meter	1	Refer: Unitta U-505		

\* The belt tensile jig is an assembly jig. Use the jig when adjusting belt tension.

The brake is mounted on each joint to prevent the arm from lowering due to its own weight while the Controller power is OFF or the motor is OFF status. The brake does not work during replacement.

Be careful when performing maintenance work.

### Attaching the labels

The motors are common to Joints #4, #5, and #6.

In order to prevent misconnection of the connectors, attach the label for the motor as shown in the photos.

#### Joint #6 motor Locations of the connector labels



X162



X062



BT62



\_BT62

Removal: Joint #6 Motor

1. Turn OFF the Controller power.
2. Remove the Arm #4 side cover.  
For details, refer to *Maintenance: 3. Covers*.
3. Loosen the screws fixing the cable protection plate on the Arm #4 and pull out the cables.

Hexagon socket head cap bolts: 2-M4×10

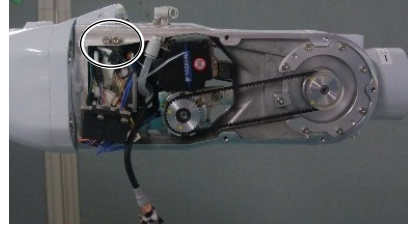

4. Remove the brake power supply connected to the connector (BR062) from the protection plate.

Cross recessed head screw with captive washer: 2-M3×6

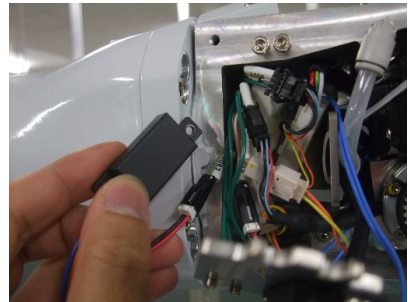

5. Pull out the cables from the Arm #4 and disconnect the following connectors.

Connectors: X062, X162, BT62, BR062

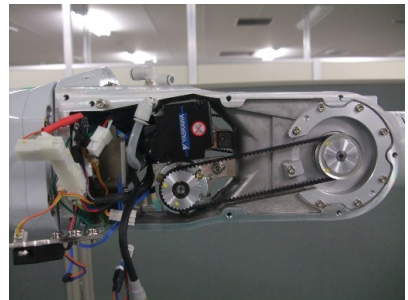

6. Loosen the bolts securing the Joint #6 motor unit and remove the belts.

Hexagon socket head cap bolts: 2-M4×15 (with a plain washer)

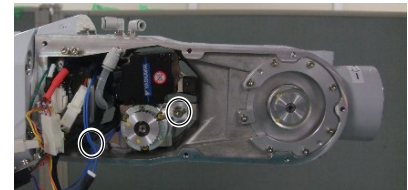

7. Remove the Joint #6 motor unit.

Hexagon socket head cap bolts: 2-M4×15 (with a plain washer)

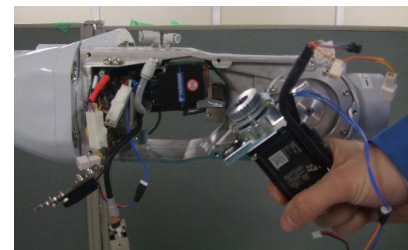



- Remove the Joint #6 motor pulley 1 and the drive boss from the Joint #6 motor unit.

Pulley 1 and drive boss screws

Hexagon socket set bolts: 2-M4×4 (with a brass bushing)

Drive boss and motor shaft screws

Hexagon socket set bolts: 2-M4×4

There is a brass bushing on one of the set screws fixing the drive boss and the pulley. Be careful not to lose it.

A: Pulley and motor shaft screws

B: Pulley and drive boss screws

C: Bushing

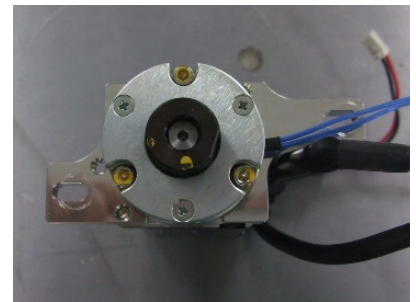
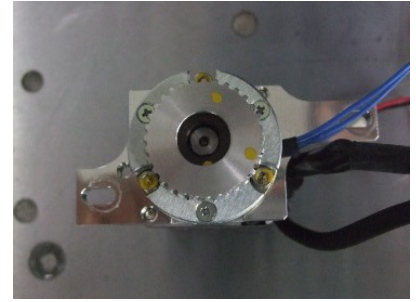
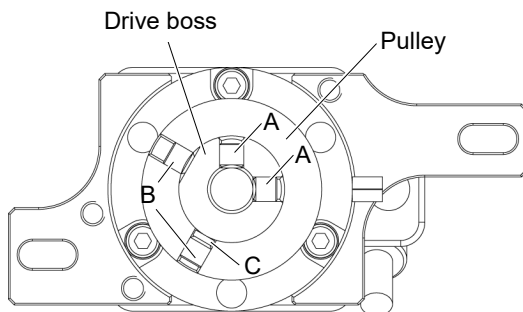

- Remove the Joint #6 electromagnetic brake.

Hexagon socket set bolts: 3-M3×15 (with a spacer)

Be careful not to lose the spacers.

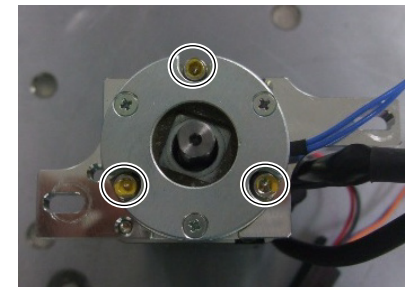

- Remove the motor plate from the Joint #6 motor.

Hexagon socket head cap bolts: 2-M4×10

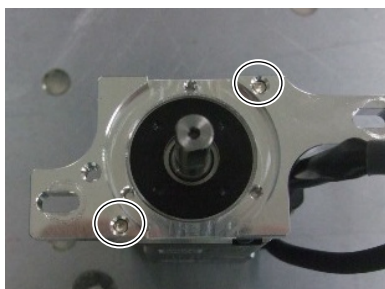

Installation: Joint #6 motor

1. Install the motor plate to the Joint #6 motor.

Hexagon socket head cap bolts: 2-M4×10

Tightening torque:  $4.0 \pm 0.2$  N·m

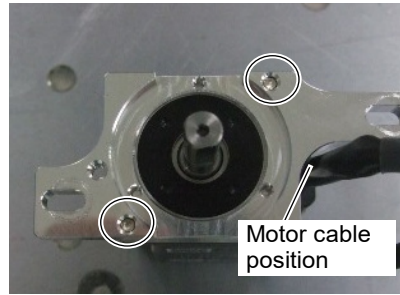

**NOTE** Be careful of the assembly direction of the motor plate.  
 (See the photo.)

2. Mount the Joint #6 electromagnetic brake to the Joint #6 motor unit. Insert the spacers between the hexagon socket set screws and the Joint #6 electromagnetic brake.

Hexagon socket set screws: 3-M3×15 (with a spacer)

Tightening torque:  $2.0 \pm 0.1$  N·m

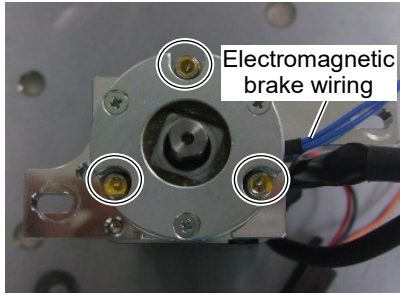

**NOTE** Be careful of the assembly direction of the Joint #5 electromagnetic brake wiring. (See the photo.)

3. Mount the drive boss and the pulley 1 to the Joint #6 motor unit.

Fix the drive boss and the motor shaft.

There is an uneven part for the feeler gauge (0.5 mm) on the boss. Use the uneven part to leave 0.5 mm space.



**NOTE** If there is no space, the parts may chafe while the motor is driving and it may result in breakage while the motor is moving.

Set the set screws to the positions indicated in the figure.

A: Pulley and motor shaft screws

B: Pulley and drive boss screws

C: Bushing

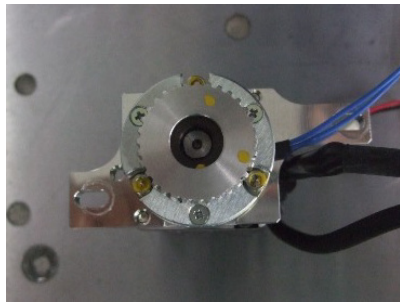
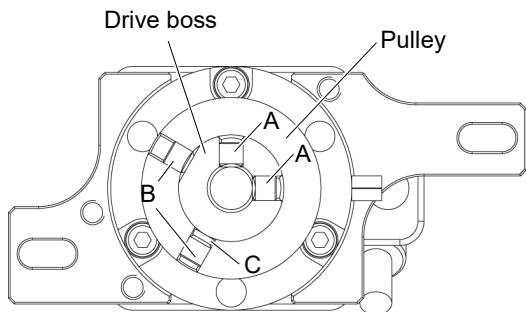
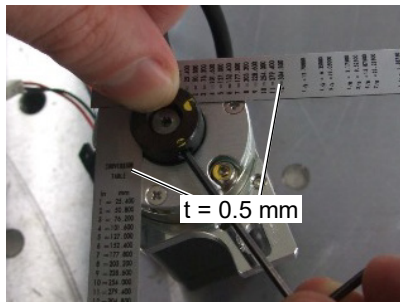

**NOTE** If the screw positions are incorrect or the bushing is not set, it may cause damage on the side of the part and may result in the part being unable to be removed.



Drive boss and the motor shaft:

Hexagon socket set screws: 2-M4×4

Tightening torque:  $2.5 \pm 0.2 \text{ N}\cdot\text{m}$

Align the screws to the two flat faces of the motor shaft and fix them.

Drive boss and the pulley 1:

Hexagon socket set screws: 2-M4×4 (with a brass bushing)

Tightening torque:  $2.5 \pm 0.2 \text{ N}\cdot\text{m}$

Fix the set screws while pressing the pulley 1 to the drive boss.

The brass bushing is not necessary for the screw for the flat surface (D-cut). Set the bushing to the other screw and then fix the screw.

4. Put the Joint #6 motor unit inside the Arm #4.
5. Pass the timing belt around the pulley 1 and pulley 2 and fix it temporarily.  
Make sure that the teeth of the timing belt engage with these of the pulley.

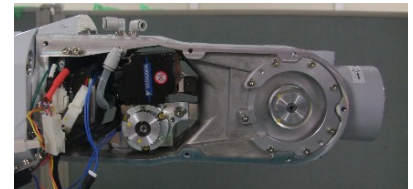

As a rough guide of temporary fixing, check that the motor unit can be moved by hand, and it does not tilt when being pulled. If the belt is too loose or too tight, it will not have proper tension.

6. Apply tension to the Joint #6 timing belt and fix the Joint #6 motor unit.

Joint #6 timing belt tension: 15 to 30 N

Belt tension meter setting value

Weight:  $2.5 \text{ g/mm width} \times \text{m span}$ , Width: 6 mm, Span: 122 mm

Hexagon socket head cap bolt: 2-M4×15 (with a plain washer)

Tightening torque:  $4.0 \pm 0.2 \text{ N}\cdot\text{m}$

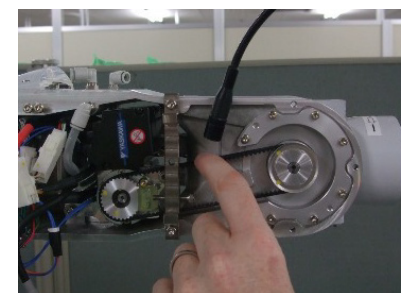
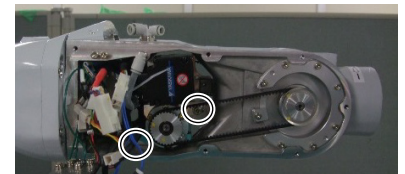

NOTE Regarding belt tension:

- Jumping (position gap) may occur if the value is below the lower limit.
- Vibration (abnormal noise) or reduction in life of the parts may occur if the value exceeds the upper limit
- When you replace with a new belt, belt may stretch and the belt tension will decrease in the initial stage of operation. Make sure to operate the robot two to three days and check the belt tension again.

When using the belt tension tensile jig (maintenance part):

Fix the belt tension tensile jig (for Joints #4, #5, and #6) with the screws (2-M4×15) and push the rubber against the pulley.

Tension is applied as the set screw (M6×15) is pushed by the rubber.

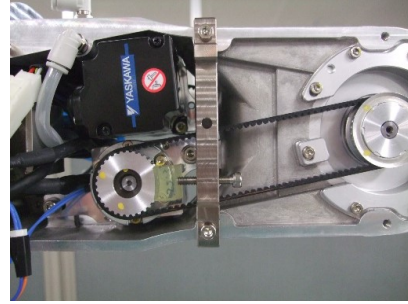

7. Connect the following connectors.

Connectors: X062, X162, BT62, BR062

8. Install the brake power supply to the plate.

Cross recessed head screw with captive washer: 2-M3×6

Tightening torque:  $0.45 \pm 0.1 \text{ N}\cdot\text{m}$

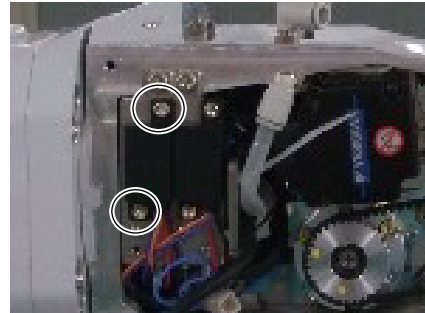

9. Fix the cable protection plate to the Arm #4.

Hexagon socket head cap bolt: 2-M4×10

Tightening torque:  $4.0 \pm 0.2 \text{ N}\cdot\text{m}$

NOTE



Be careful not to get the cables caught. It may result in cable breakage.

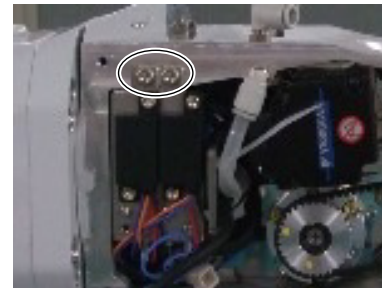

10. Install the Arm #4 side cover.

For details, refer to *Maintenance: 3. Covers*.

11. Perform the calibration.

For details, refer to *Maintenance: 16. Calibration*.

## 10.2 Joint #6 - Replacing the Reduction Gear Unit (Replacing the Joints #5, #6 Reduction Gear Unit Set)

For replacement of the Joint #5 and Joint #6 reduction gear unit, replace the Joints #5, #6 reduction gear unit set.

The Joints #5 and #6 reduction gear unit set is adjusted in advance.

	Name	Qty.	Note	
Maintenance Parts	Joints #5, #6 Reduction gear unit set	1	1674610 (common to C8 series)	
	Belt tensile jig*	1	1674582	
Tools	Hexagonal wrench	width across flats: 2 mm	1	For M4 hexagon socket set screws
		width across flats: 2.5 mm	1	For M3 hexagon socket head cap bolts
		width across flats: 3 mm	1	For M4 hexagon socket head cap bolts
		width across flats: 4 mm	1	For M5 hexagon socket head cap bolts
		width across flats: 5 mm	1	For M6 hexagon socket head cap bolts
	Cross-point screwdriver (#2)	1	For cross recessed head screws	
	Torque wrench	1	For tightening torque control	
	Spanner ( width across flats: 8 mm)	1	For air fittings	
	Feeler gauge (0.5 mm)	2	For drive boss position adjustment	
	Belt tension meter	1	Refer: Unitta U-505	

For details of the replacement procedure, refer to *Maintenance 9.2 Joint #5 - Replacing the Reduction Gear Unit (Replacing the Joints #5, #6 Reduction Gear Unit)*.

The brake is mounted on each joint to prevent the arm from lowering due to its own weight while the Controller power is OFF or the motor is OFF status. The brake does not work during replacement.

Be careful when performing maintenance work.

### 10.3 Joint #6 - Replacing the Timing Belt

	Name		Qty.	Note
Maintenance Parts	Joint #6 timing belt	339 mm	1	1655933
	Belt tensile jig		1	1674582
Tools	Hexagonal wrench (width across flats: 3 mm)		1	For M4 hexagon socket head cap bolts
	Cross-point screwdriver (#2)		1	For cross recessed head screws
	Belt tension meter		1	Refer: Unitta U-505

\* The belt tensile jig is an assembly jig. Use the jig when adjusting belt tension.

The brake is mounted on each joint to prevent the arm from lowering due to its own weight while the Controller power is OFF or the motor is OFF status. The brake does not work during replacement.

Be careful when performing maintenance work.

#### Removal: Joint #6 Timing belt

1. Turn OFF the Controller power.
2. Remove the Arm #4 side cover.  
For details, refer to *Maintenance: 3. Covers*.
3. Loosen the Joint #6 motor unit set screw.  
Hexagon socket head cap bolt: 2-M4×15 (with a plain washer)

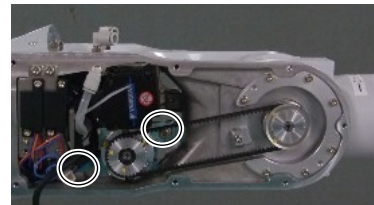

4. Remove the Joint #6 timing belt.

#### Installation: Joint #6 Timing belt

1. Place the Joint #6 timing belt around the pulley 1 and 2 of the Joint #6.
2. Secure the Joint #6 motor unit.  
For details, refer to *Maintenance: 10.1 Joint #6 – Replacing the Motor*, Installation steps (5) to (6) and (10) to (11).

## 10.4 Joint #6 - Replacing the Electromagnetic Brake

	Name	Qty.	Note	
Maintenance Parts	Electromagnetic brake	1	2172928 (Common to Joints #4, #5, #6)	
	Belt tensile jig	1	1674582	
Tools	Hexagonal wrench	width across flats: 2 mm	1	For M4 hexagon socket set screws
		width across flats: 2.5 mm	1	For M3 hexagon socket head cap bolts
		width across flats: 3 mm	1	For M4 hexagon socket head cap bolts
	Cross-point screwdriver (#2)	1	For cross recessed head screws	
	Feeler gauge (0.5 mm)	1	For adjusting the pulley position	
	Belt tension meter	1	Refer: Unitta U-505	

\* The belt tensile jig is an assembly jig. Use the jig when adjusting belt tension.

The brake is mounted on each joint to prevent the arm from lowering due to its own weight while the Controller power is OFF or the motor is OFF status. The brake does not work during replacement. Be careful when performing maintenance work.

### Attaching the labels

The electromagnetic brakes are common to Joints #4, #5, and #6.

In order to prevent misconnection of the connectors, attach the label for the electromagnetic brakes as shown in the photos.

Joint #6 electromagnetic brakes      Locations of the connector labels

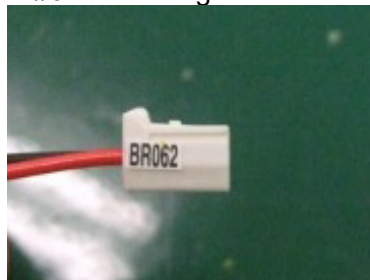

BR062  
Cable (red/black)



BR063  
Cable (blue/blue)



BR063  
Cable (blue/orange)



NOTE BR063 is connected at the time of shipment. Before attaching the label, disconnect the connector.

One side of BR062 and BR063 have the same shape. Identify the connectors by color.

**Removal: Joint #6 Electromagnetic brake**

1. Remove the Joint #6 electromagnetic brake.

For details, refer to *Maintenance: 10.1 Joint #6 – Replacing the Motor*, Removal steps (1) through (9).

**Installation: Joint #6 Electromagnetic brake**

1. Mount the Joint #6 electromagnetic brake to the Joint #6 motor unit.

For details, refer to *Maintenance: 10.1 Joint #6 – Replacing the Motor*, Installation steps (2) through (11).

## 11. Replacing the Battery Unit

 WARNING	<ul style="list-style-type: none"> <li>■ Do not connect or disconnect the motor connectors while the power to the robot system is turned ON. Connecting or disconnecting the motor connectors with the power ON is extremely hazardous and may result in serious bodily injury as the Manipulator may move abnormally, and also may result in electric shock and/or malfunction of the robot system.</li> <li>■ To shut off power to the robot system, disconnect the power plug from the power source. Be sure to connect the AC power cable to a power receptacle. DO NOT connect it directly to a factory power source.</li> <li>■ Before performing any replacement procedure, turn OFF the Controller and related equipment, and then disconnect the power plug from the power source. Performing any replacement procedure with the power ON is extremely hazardous and may result in electric shock and/or malfunction of the robot system.</li> </ul>
--	---

 WARNING	<ul style="list-style-type: none"> <li>■ Take meticulous care when handling the lithium battery. Improper handling of the lithium battery as mentioned below is extremely hazardous and may result in heat generation, leakage, explosion, or inflammation. It also may cause serious safety problems.                      &lt;Improper Handling&gt;                     <table style="width: 100%; border: none;"> <tr> <td style="width: 50%;">Attempting to charge</td> <td style="width: 50%;">Deforming by pressure</td> </tr> <tr> <td>Disassembling</td> <td>Short-circuit (Polarity; Positive/Negative)</td> </tr> <tr> <td>Connecting batteries improperly</td> <td>Heating (85 °C or more)</td> </tr> <tr> <td>Exposing to fire</td> <td>Soldering the terminal of the lithium battery directly</td> </tr> <tr> <td>Forcing discharge</td> <td></td> </tr> </table> </li> <li>■ When disposing the battery, consult with the professional disposal services or comply with the local regulation. Make sure that the battery terminal is insulated, even for a used battery. If the terminal contacts with the other metals, it may short and result in heat generation, leakage, explosion, or inflammation.</li> </ul>	Attempting to charge	Deforming by pressure	Disassembling	Short-circuit (Polarity; Positive/Negative)	Connecting batteries improperly	Heating (85 °C or more)	Exposing to fire	Soldering the terminal of the lithium battery directly	Forcing discharge	
Attempting to charge	Deforming by pressure										
Disassembling	Short-circuit (Polarity; Positive/Negative)										
Connecting batteries improperly	Heating (85 °C or more)										
Exposing to fire	Soldering the terminal of the lithium battery directly										
Forcing discharge											

In case of the low lithium battery power, the error to warn the voltage reduction occurs at the Controller startup (the software startup). All position data will be lost and you will need to calibrate all joints.

The life span of the lithium battery varies depending on the energizing hours and installation environment of the Controller. It is about 3 years as a rough guide (when the Controller is connected to power for 8 hours a day). When the Controller is not connected to power, the battery consumption will significantly increase compared to when the Controller is energized. If warnings of voltage reduction occur, replace the lithium metal battery even if it has not reached the above product life.



For the EPSON RC+ 7.0 Ver. 7.2.x or later (firmware Ver.7.2.x.x or later), the recommended replacement time for the battery can be checked in the [Maintenance] dialog box of the EPSON RC+ 7.0.

For details, refer to the following manual.

*Robot Controller RC700 / RC700-A Maintenance 6. Alarm*

## Maintenance 11. Replacing the Battery Unit

The battery may run out if it passes the recommended replacement time.

If no warnings of voltage reduction occur, the calibration for all joints is not necessary. You need to perform calibration if the position moves from the originals after replaced the battery.

Designated parts must be used for the lithium battery and battery board.

Be careful of the battery polarity to connect it correctly.

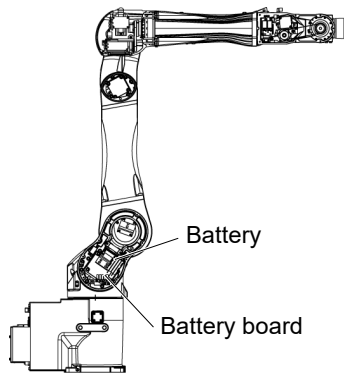

(Figure: C8-A1401\*\* (C8XL))

	Name	Qty.	Note
Maintenance Parts	Battery unit (Lithium battery)	1	2172925 (Two lithium batteries for replacement)
	Battery board	1	2173216
Tools	Cross-point screwdriver (#2)	1	For cross recessed head screws
	Hexagonal wrench (width across flats: 3 mm)	1	For M4 hexagon socket head cap bolts



## 11.1 Replacing the Battery Unit (Lithium Battery)

1. Turn OFF the Controller power.
2. Remove the Arm #1 side cover.  
For details, refer to *Maintenance: 3. Covers*.
3. Remove the battery from the battery box.

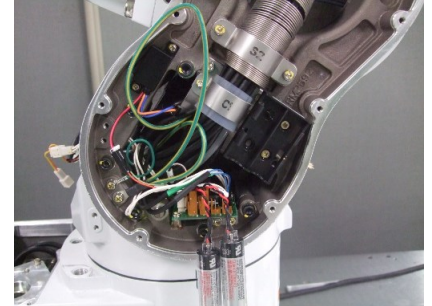

**NOTE**  If you removed all the batteries before connecting the new ones, the calibration data will be deleted and you will need to perform calibration. Follow the steps below to remove the lithium batteries.

4. Connect the two new batteries to the connectors of the battery board which are not connected to anything.

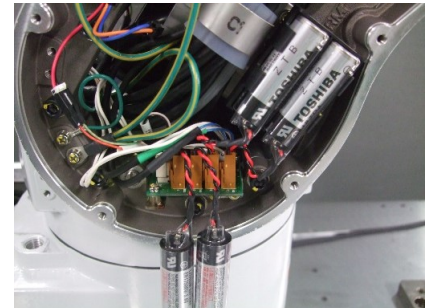

5. Remove the old batteries.  
Hold the board by hand and pull the battery cable upward to remove the connector.

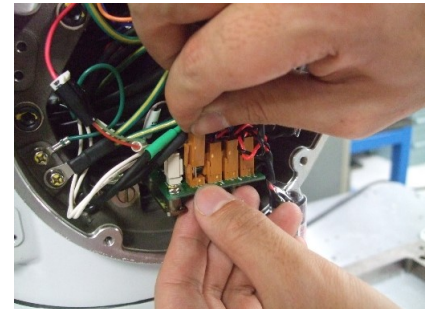

6. Install the battery to the battery box.



7. Install the Arm #1 side cover.  
For details, refer to *Maintenance: 3. Covers*.
8. Turn ON the Controller power.
9. Check operation to see if the Manipulator's position and posture are out of position.  
Move the Manipulator to two or three points (poses) of the registered points.
10. If the Manipulator is out of position, calibrate all the joints and axes.  
For details, refer to *Maintenance: 16. Calibration*.

## 11.2 Replacing the Battery Board

After parts have been replaced (motors, reduction gear units, brakes, timing belts, etc.), the Manipulator cannot perform positioning properly because a gap exists between the origin stored in each motor encoder and its corresponding origin stored in the Controller. Therefore, it is necessary to match these origins after replacing the parts.

The process of aligning the two origins is called “Calibration”.

Refer to *Maintenance 16. Calibration* and perform the calibration after the parts replacement.

### Removal: Battery board

1. Turn OFF the Controller power.
2. Remove the Arm #1 side cover.  
For details, refer to *Maintenance: 3. Covers*.
3. Remove the battery from the battery box.

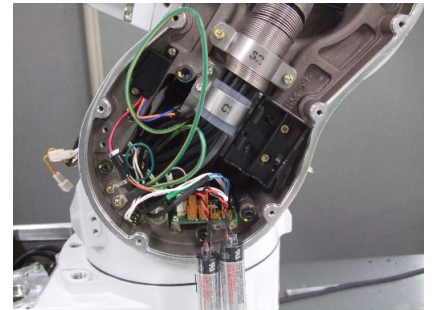

4. Remove the battery connectors.

**NOTE**  Hold the board by hand and pull the battery cable upward to remove the connector.

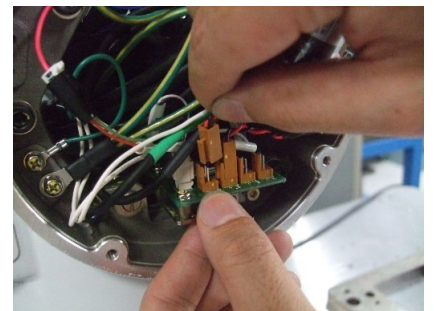

5. Remove the plate where the battery box is fixed to.  
Hexagon socket head cap bolts: 2-M4×10

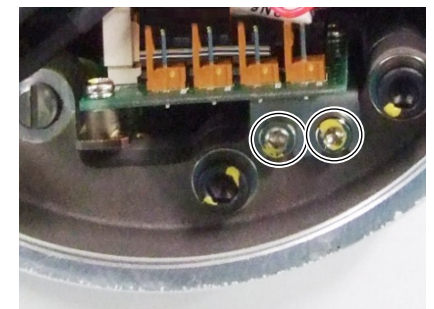

6. Remove the connectors.  
Connectors: CN3, CN6

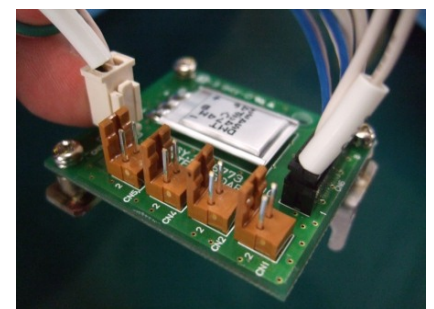

## Maintenance 11. Replacing the Battery Unit

---

7. Remove the battery board fixed to the plate.

Cross recessed head screws: 3-M3×6

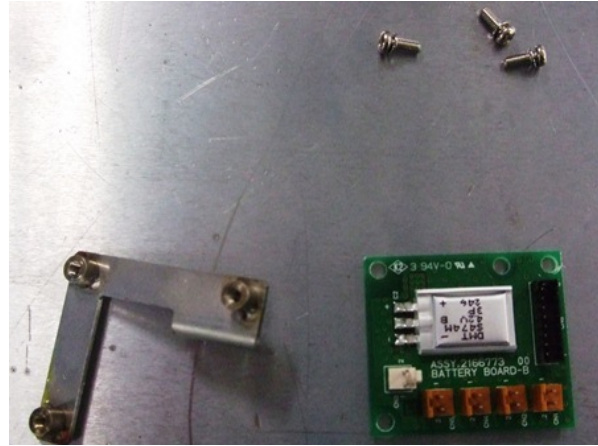
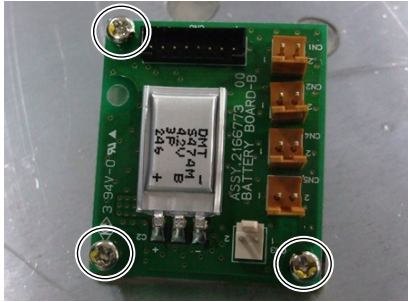

## Installation: Battery board

1. Install the battery board to the plate.

Cross recessed head screws: 3-M3×6

Tightening torque:  $0.45 \pm 0.1$  N·m

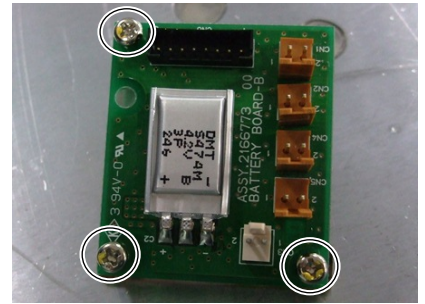

2. Connect the connectors to the battery board.

Connector: CN3, CN6

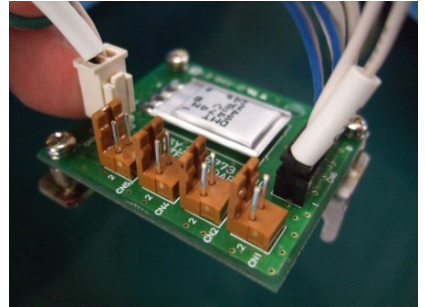

3. Install the plate where the battery board is installed to.

Hexagon socket head cap bolts: 2-M4×10

Tightening torque:  $4.0 \pm 0.2$  N·m

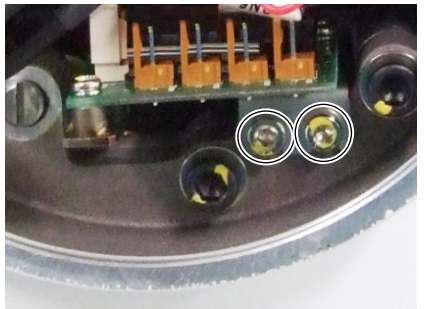

4. Connect the battery connectors.

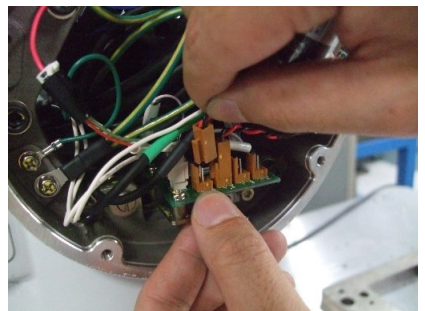

5. Install the battery to the battery box.

6. Install the Arm #1 side cover.

For details, refer to *Maintenance: 3. Covers.*

7. Perform the calibration.

For details, refer to *Maintenance: 16. Calibration.*



## 12. Replacing the Control Board

	<ul style="list-style-type: none"> <li>■ Do not connect or disconnect the motor connectors while the power to the robot system is turned ON. Connecting or disconnecting the motor connectors with the power ON is extremely hazardous and may result in serious bodily injury as the Manipulator may move abnormally, and also may result in electric shock and/or malfunction of the robot system.</li> <li>■ To shut off power to the robot system, disconnect the power plug from the power source. Be sure to connect the AC power cable to a power receptacle. DO NOT connect it directly to a factory power source.</li> <li>■ Before performing any replacement procedure, turn OFF the Controller and related equipment, and then disconnect the power plug from the power source. Performing any replacement procedure with the power ON is extremely hazardous and may result in electric shock and/or malfunction of the robot system.</li> </ul>
---	---

Designated parts must be used for the control board.

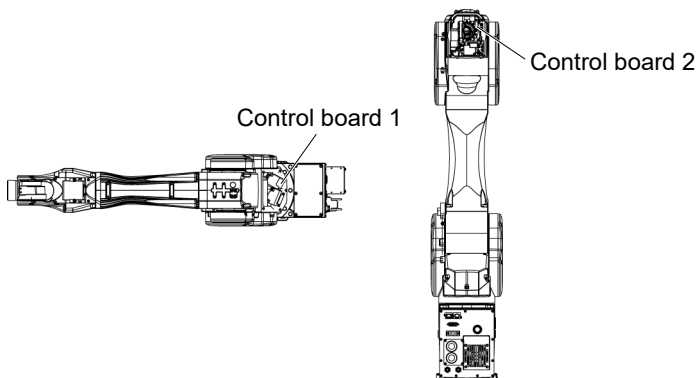

(Figure: C8-A1401\*\* (C8XL))

	Name	Qty.	Note
Maintenance Parts	Control board (1, 2)	1	2138032
Tools	Hexagonal wrench (width across flats: 3 mm)	1	For M4 hexagon socket head cap bolts
	Spanner (width across flats: 5.5 mm)	1	For spacers
	Cross-point screwdriver	1	For cross recessed head screws



## 12.1 Replacing the Control Board 1

### Removal: Control board 1

1. Turn OFF the Controller.
2. Remove the Arm #1 center cover.  
For details, refer to *Maintenance 3. Covers*.
3. Remove the connector connected to the control board 1.

Connector: GS01

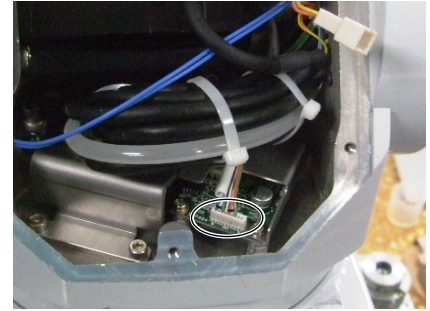

4. Remove the control board 1 fixed to the Arm #1.

Cross recessed head screws: 3-M3×8

**NOTE** Be careful not to drop the screws inside the Manipulator while removing them.



5. Remove the control board 1 protection plate.  
Cross recessed head screws with captive washer: M3×6

It is not necessary to remove the spacer from the plate.

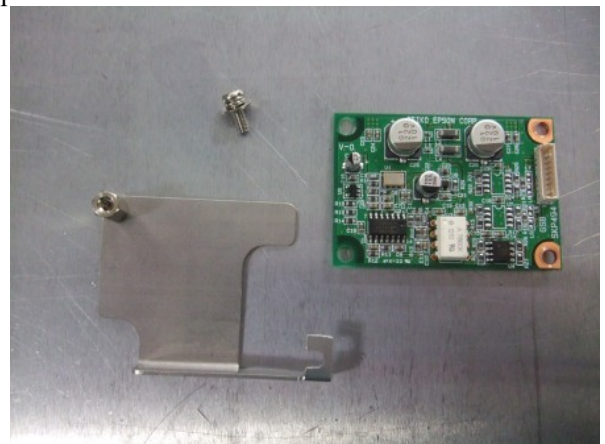

Installation: Control board 1

1. Install the control board 1 protection plate.  
Cross recessed head screws with captive washer: M3×6  
Tightening torque:  $0.45 \pm 0.1$  N·m

 NOTE Be careful of the assembly direction of the protection plate.  
(See the photo)

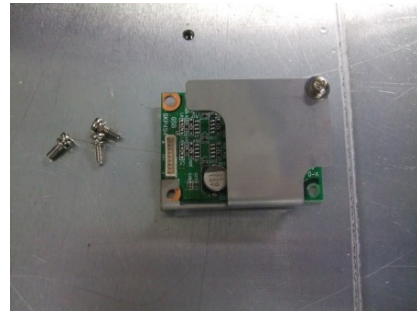
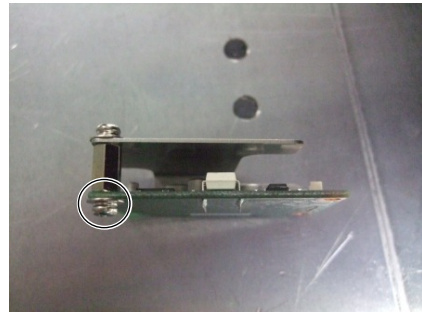

2. Install the control board 1 to the Arm #1.  
Cross recessed head screws: 3-M3×8  
Tightening torque:  $0.45 \pm 0.1$  N·m

 NOTE Be careful not to drop the screws inside the Manipulator while removing them.

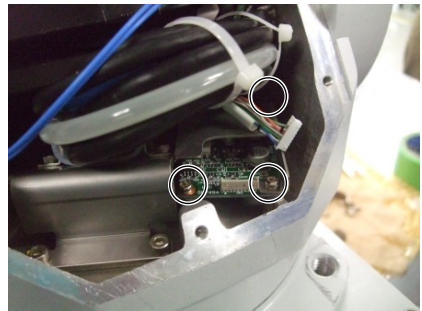

3. Connect the connector to the control board 1.  
Connector: GS01

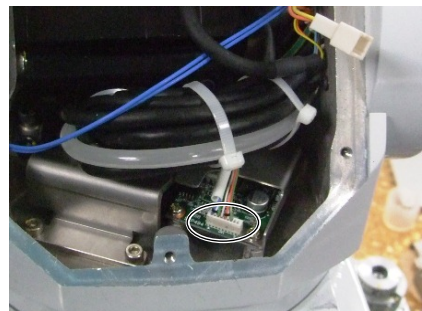

4. Install the Arm #1 center cover.  
For details, refer to *Maintenance: 3. Covers*.
5. Check operation to see if the Manipulator's position and posture are out of position.  
Move the Manipulator to two or three points (poses) of the registered points.
6. If the Manipulator is out of position, calibrate all the joints and axes.  
For details, refer to *Maintenance: 16. Calibration*.



## 12.2 Replacing the Control Board 2

### Removal: Control board 2

1. Turn OFF the Controller power.
2. Remove the Arm #3 cover.  
For details, refer to *Maintenance: 3. Covers*.
3. Remove the connector connected to the control board 2.

Connector: GS02

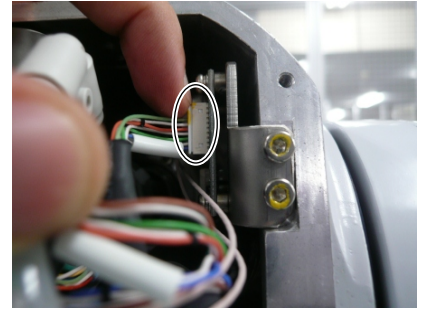

4. Remove the plate fixed to the Arm #3.  
Hexagon socket head cap bolts: 2-M4×10

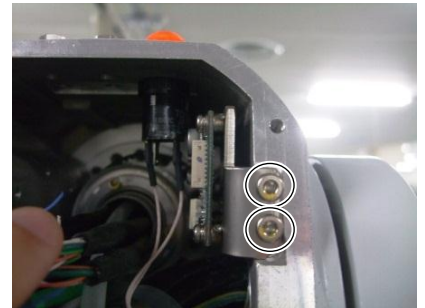

5. Remove the control board 2 fixed to the plate.  
Cross recessed head screws: 4-M3×8

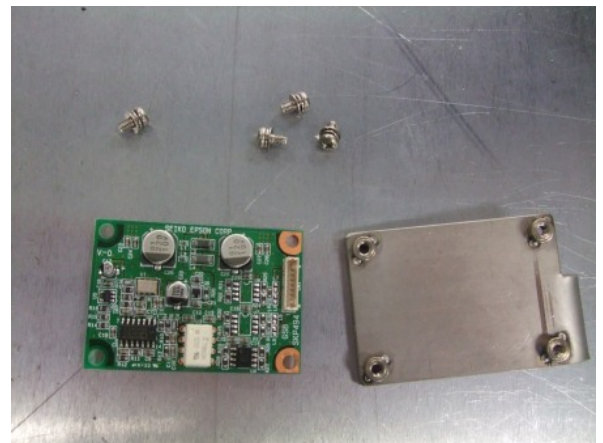
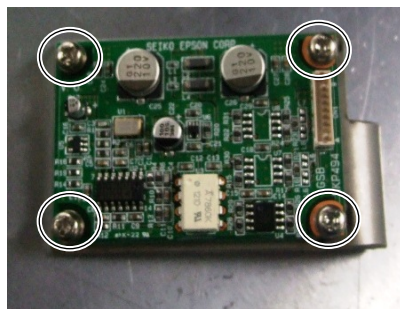

Installation: Control board 2

1. Install the control board 2 to the plate.

Cross recessed head screws: 4-M3×8

Tightening torque:  $0.45 \pm 0.1 \text{ N}\cdot\text{m}$

NOTE  Be careful of the assembly direction of the control board 2.  
(See the photo.)



2. Install the plate with the control board 2 to the Arm #3.

Hexagon socket head cap bolts: 2-M4×10

Tightening torque:  $4.0 \pm 0.2 \text{ N}\cdot\text{m}$

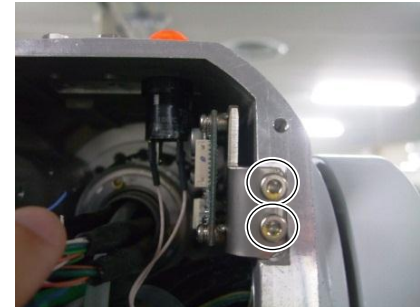

3. Connect the connector to the control board 2.

Connector: GS02

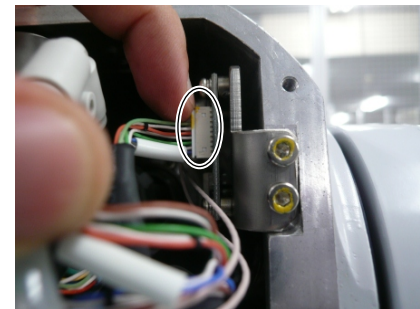

4. Install the Arm #3 cover.

For details, refer to *Maintenance: 3. Covers*.

5. Turn ON the Controller power.

6. Check operation to see if the Manipulator's position and posture are out of position.

Move the Manipulator to two or three points (poses) of the registered points.

7. If the Manipulator is out of position, calibrate all the joints and axes.

For details, refer to *Maintenance: 16. Calibration*.

## 13. Replacing the LED Lamp



- Do not connect or disconnect the motor connectors while the power to the robot system is turned ON. Connecting or disconnecting the motor connectors with the power ON is extremely hazardous and may result in serious bodily injury as the Manipulator may move abnormally, and also may result in electric shock and/or malfunction of the robot system.
- To shut off power to the robot system, disconnect the power plug from the power source. Be sure to connect the AC power cable to a power receptacle. DO NOT connect it directly to a factory power source.
- Before performing any replacement procedure, turn OFF the Controller and related equipment, and then disconnect the power plug from the power source. Performing any replacement procedure with the power ON is extremely hazardous and may result in electric shock and/or malfunction of the robot system.

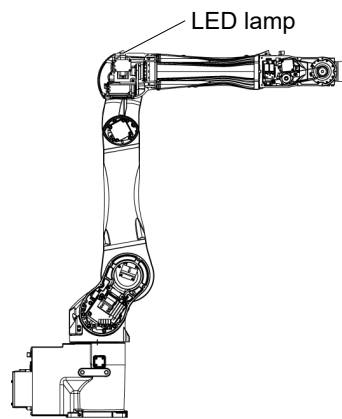

(Figure: C8-A1401\*\* (C8XL))

	Name	Qty.	Note
Maintenance Parts	LED lamp	1	1668127 (Standard, Clean-room models)
Tools	Cross-point screwdriver (#2)	1	For cross recessed head screws

For Protection model, please contact the supplier of your region.

Removal: LED lamp

1. Turn OFF the Controller power.
2. Remove the Arm #3 cover.  
For details, refer to *Maintenance: 3. Covers*.
3. Remove the connector connected to the LED lamp.  
The connector for the LED lamp (LED) is under the Arm #3 cover.  
Connector: LED
4. Remove the LED lamp from the Arm #3.

Turn the plastic nut securing the LED lamp in the Arm #3 counterclockwise.

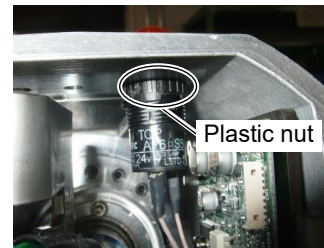



Installation: LED lamp

1. Install the LED lamp to the Arm #3.  
Remove the plastic nut from the LED lamp.  
Pass the lamp from the inside of the Arm #3.  
Turn the nut clockwise and secure the lamp to the Arm #3.
2. Connect the following connector.  
Connector: LED
3. Install the Arm #3 cover.  
For details, refer to *Maintenance: 3. Covers*.

## 14. Replacing the M/C Cable

Each motor is fed power by the battery for backup. Therefore, position data is held even after turning OFF the Controller. The position data will be lost when the cable connector connected to the battery is disconnected. And the EPSON RC+ will display the error message of encoder alarm occurrence when the Controller is turned ON.

 <p>WARNING</p>	<ul style="list-style-type: none"> <li>■ Do not connect or disconnect the motor connectors while the power to the robot system is turned ON. Connecting or disconnecting the motor connectors with the power ON is extremely hazardous and may result in serious bodily injury as the Manipulator may move abnormally, and also may result in electric shock and/or malfunction of the robot system.</li> <li>■ To shut off power to the robot system, disconnect the power plug from the power source. Be sure to connect the AC power cable to a power receptacle. DO NOT connect it directly to a factory power source.</li> <li>■ Before performing any replacement procedure, turn OFF the Controller and related equipment, and then disconnect the power plug from the power source. Performing any replacement procedure with the power ON is extremely hazardous and may result in electric shock and/or malfunction of the robot system.</li> </ul>
--	---

 <p>CAUTION</p>	<ul style="list-style-type: none"> <li>■ When disconnecting the connectors during the replacement of the cable unit, be sure to reconnect the connectors to their proper positions. Improper connection of the connectors may result in improper function of the robot system. For details on the connections, please contact the supplier of your region.</li> <li>■ When installing the cover, be careful not to allow the cables to interfere with the cover mounting and do not bend these cables forcibly to push them into the cover. Unnecessary strain on cables may result in damage to the cables, disconnection, and/or contact failure. These are extremely hazardous and may result in electric shock and/or improper function of the robot system. When routing the cables, check the cable locations after removing the cover. Be sure to place the cables back to their original locations.</li> <li>■ Be sure to connect the cables properly. Do not allow unnecessary strain on the cables. (Do not put heavy objects on the cables. Do not bend or pull the cables forcibly.) Unnecessary strain on cables may result in damage to the cables, disconnection, and/or contact failure. These are extremely hazardous and may result in electric shock and/or improper function of the robot system.</li> </ul>
--	--

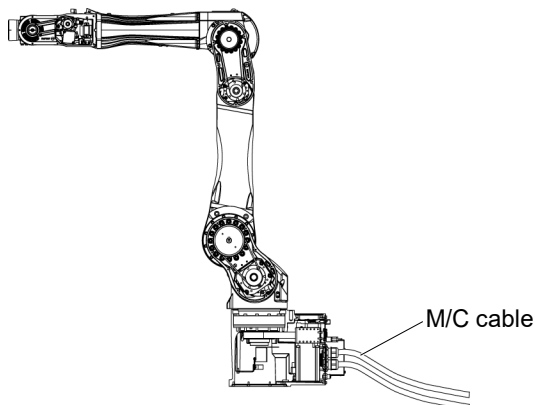

(Figure: C8-A1401\*\* (C8XL))

Maintenance 14. Replacing the M/C Cable

	Name		Qty.	Note		
Maintenance Parts	M/C cable	3 m	Straight	1	R12NZ900S1	
			L-shaped	1	R12NZ900S5	
		5 m	Straight	1	R12NZ900S2	
			L-shaped	1	R12NZ900S6	
		10 m	Straight	1	R12NZ900S3	
			L-shaped	1	R12NZ900S7	
		15 m	Straight	1	R12NZ900YC	
			L-shaped	1	R12NZ900YB	
		20 m	Straight	1	R12NZ900S4	
			L-shaped	1	R12NZ900S8	
		M/C cable (flexible)	3 m	Straight	1	R12NZ900S9
				L-shaped	1	R12NZ900SD
	5 m		Straight	1	R12NZ900SA	
			L-shaped	1	R12NZ900SE	
	10 m		Straight	1	R12NZ900SB	
			L-shaped	1	R12NZ900SF	
	15 m		Straight	1	R12NZ900YE	
			L-shaped	1	R12NZ900YD	
20 m	Straight		1	R12NZ900SC		
	L-shaped		1	R12NZ900SG		
Tools	Hexagonal wrench (width across flats: 3 mm)		1	For M4 hexagon socket head cap bolts		

**Removal: M/C cable**

1. Turn OFF the Controller power.
2. Disconnect the following connectors from the Controller.
  - Power cable connector
  - Signal cable connector

3. Remove the connector plate.
  - For details, refer to *Maintenance: 3. Covers*.

## NOTE



Do not pull the connector plate forcibly.

Do not disconnect the M/C cable from the connector plate.

4. Remove the connectors.
  - Connectors: X11, X12, X14, BR010, X010, X020, X040, LED, GS01

## NOTE



Each connector is numbered and has a different shape.

Do not disconnect the battery connector (BT1\*). Otherwise, calibration will be required.

For details, refer to *Maintenance: 16. Calibration*.

5. Remove the connector sub plate.
  - For details, refer to *Maintenance: 3. Covers*.

Installation: M/C cable

1. Install the connector sub plate.  
For details, refer to *Maintenance: 3. Covers*.
2. Connect the connectors of the new M/C cable to these of the cable unit.  
Connector: X11, X12, X14, BR010, X010, X020, X040, LED, GS01
3. Install the connector plate.  
For details, refer to *Maintenance: 3. Covers*.
4. Connect the following connectors to the Controller.  
Power cable connector  
Signal cable connector
5. Turn ON the Controller power.
6. Check operation to see if the Manipulator's position and posture are out of position.  
Move the Manipulator to two or three points (poses) of the registered points.
7. If the battery connector (BT1\*) was disconnected, calibrate the Joint #1.  
For details, refer to *Maintenance: 16. Calibration*.
8. If the Manipulator is off position, calibrate all the joints and axes.  
For details, refer to *Maintenance: 16. Calibration*.



## 15. Replacing the Fan



- Do not connect or disconnect the motor connectors while the power to the robot system is turned ON. Connecting or disconnecting the motor connectors with the power ON is extremely hazardous and may result in serious bodily injury as the Manipulator may move abnormally, and also may result in electric shock and/or malfunction of the robot system.
- To shut off power to the robot system, disconnect the power plug from the power source. Be sure to connect the AC power cable to a power receptacle. DO NOT connect it directly to a factory power source.
- Before performing any replacement procedure, turn OFF the Controller and related equipment, and then disconnect the power plug from the power source. Performing any replacement procedure with the power ON is extremely hazardous and may result in electric shock and/or malfunction of the robot system.

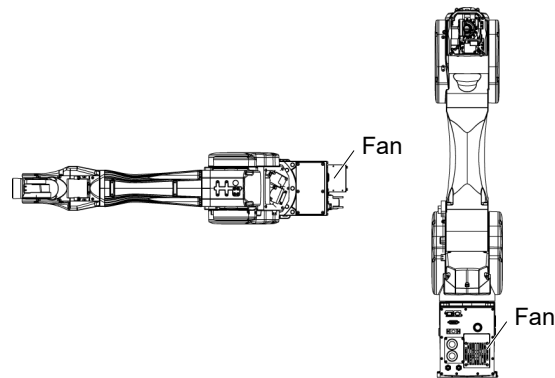

(Figure: C8-A1401\*\* (C8XL))

	Name	Qty.	Note
Maintenance Part	Fan	1	2177465 (standard, cleanroom models)
			2178399 (protection model)
Tool	Cross-point screwdriver	1	For cross recessed head screws

(Figure: Cable backward model)

**Removal: Fan**

1. Remove the fan cover screws while supporting the cover.

Cross recessed head screws with washer: 4-M4×35

NOTE The cover falls when the screws are removed.

 When removing the screws, be sure to support the cover.

2. Remove the fan cover.
3. Remove the fan connectors.
4. Remove the fan.

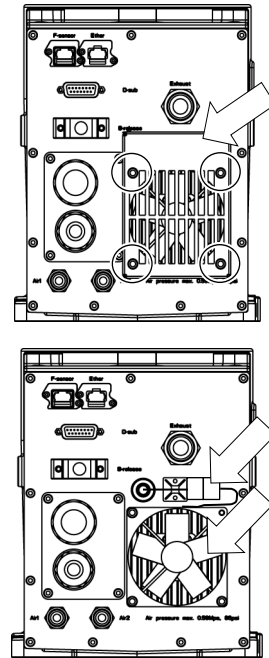

**Installation: Fan**

1. Install the fan.

NOTE Be careful of the installation direction of the fan.

 The arrow on the fan (indicated with the arrow in the photo) should point the heat sink, and the cables should come to the upper side of the fan.

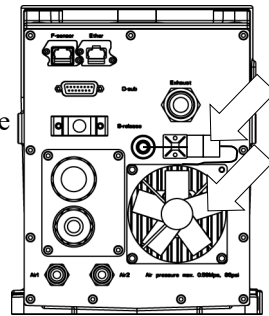
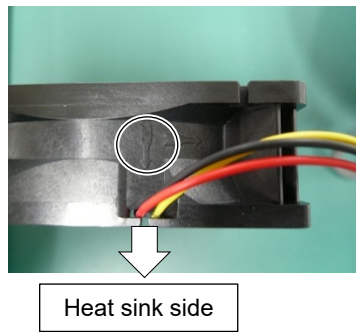

2. Connect the fan connectors.
3. Install the fan cover.

Cross recessed head screws with washer: 4-M4×35

Tightening torque: 0.9 ± 0.1 N·m

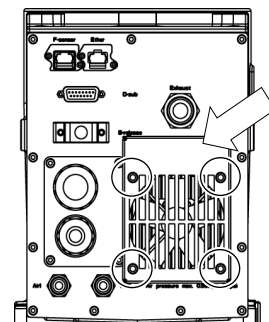

## 16. Calibration

### 16.1 Overview

After parts have been replaced (motors, reduction gear units, timing belts, etc.), the Manipulator cannot perform positioning properly because a gap exists between the origin stored in each motor encoder and its corresponding origin stored in the Controller.

Therefore, it is necessary to match these origins after replacing the parts.

The process of aligning the two origins is called “Calibration”. Note that calibration is not the same as teaching\*.

\* “Teaching” means to teach the Controller coordinate points (including poses) anywhere in the operating area of the Manipulator.



- To ensure safety, a safeguard must be installed for the robot system. For details on the safeguard, refer to the *Installation and Design Precautions* in the *Safety* chapter of the *EPSON RC+ User's Guide*.
- Before operating the robot system, make sure that no one is inside the safeguarded area. The robot system can be operated in the mode for teaching even when someone is inside the safeguarded area. The motion of the Manipulator is always in restricted (low speeds and low power) status to secure the safety of an operator. However, operating the robot system while someone is inside the safeguarded area is extremely hazardous and may result in serious safety problems in case that the Manipulator moves unexpectedly.

In EPSON RC+, a coordinate point including the arm pose is defined as “point” and its data is called “point data”.

There are two methods to move the Manipulator during calibration.

- Releasing the electromagnetic brake and moving the arms manually.

For details, refer to the *Setup & Operation 1.5 How to Move Arms with the Electromagnetic Brake*.

- Moving the Manipulator using Jog & Teach.

Moving the Manipulator while releasing the electromagnetic brake involves risk as described below.

It is recommended to move the Manipulator using Jog & Teach.



- Normally, release the brake of joints one by one. Take extra care if you need to release the brakes of two or more joints simultaneously. Releasing the brakes of two or more joints simultaneously may cause hands and fingers to be caught and/or equipment damage to or malfunction of the Manipulator as the arms of the Manipulator may move in unexpected directions.
- Be careful of the arm falling when releasing the brake. While the brake is being released, the Manipulator's arm falls by its own weight. The arm falling may cause hands and fingers to be caught and/or may cause equipment damage to or malfunction of the Manipulator.

Also, pay attention to the following points at the encoder initialization.

 <b>CAUTION</b>	<ul style="list-style-type: none"> <li>■ The Joint #1 and Joint #4 have no mechanical stops and they may be rotated more than 360 degrees. If the encoder initialization is performed with improper posture, the Manipulator moves outside the operation range. If the Manipulator was moved outside the operation range, the internal wiring may be damaged by being twisted or pinched and it may result in Manipulator malfunction.</li> </ul>
---	---

NOTE  

When the home positions of the Joints #1 and #4 are uncertain, check torsion of the internal cables. The home positions are where the Manipulator has the internal cables not twisted at the basic orientation described in *Setup & Operation 3.7 Checking the Basic orientation*.

Torsion of the internal cables can be checked by removing the following covers.

Joint #1 : Base cover (Cable backward model)

: Connector plate (Cable downward model)

Joint #4 : Arm #3 cover

(common between cable downward and cable backward models)

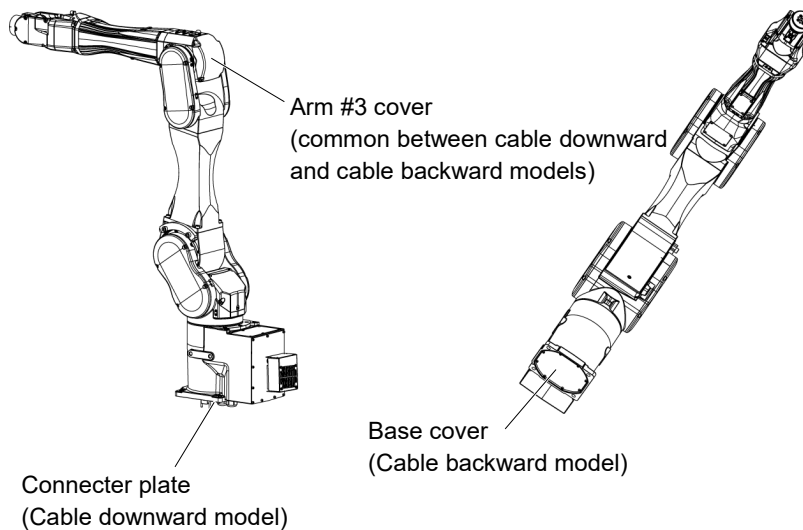

For details on Jog & Teach, refer to the following manual.

*EPSON RC+ User's Guide*

*5.11.1 Robot Manager Command Tools: Robot Manager: Jog and Teach Page.*



- For details about the basic orientation, refer to *Setup & Operation 3.7 Checking the Basic orientation.*
- Whenever possible, calibrate one joint at a time. (Also, replace parts of one joint at a time whenever possible.) If you calibrate the origins for multiple joints simultaneously, it will be more difficult to verify their origins and obtain the origin correct positions. However, joint #5 cannot be calibrated alone due to the structure of the Manipulator. Make sure you calibrate joint #5 and #6 at the same time.

Calibration Flowchart

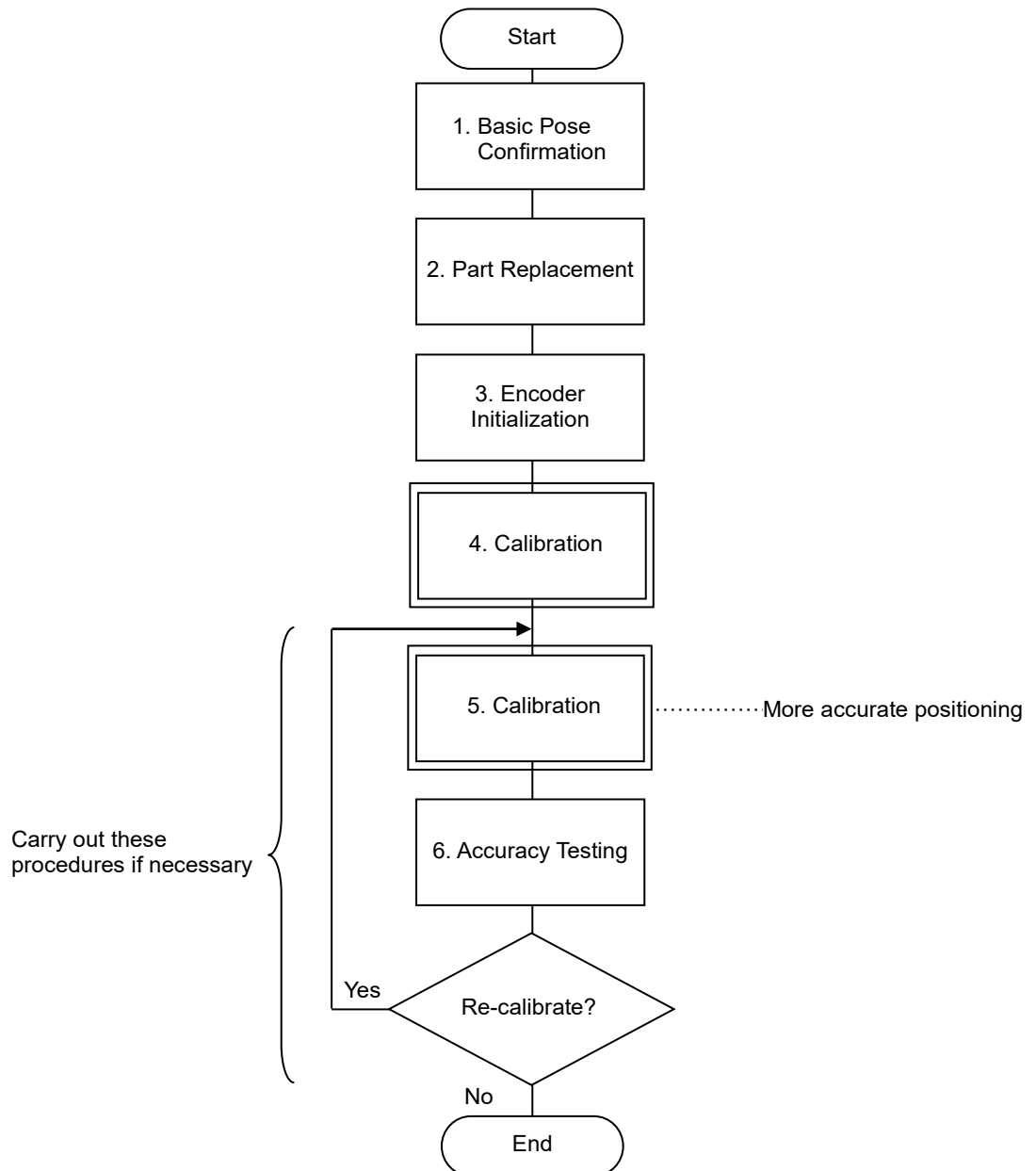

## 16.2 Calibration Procedure

### Command Input

Command execution is required in some calibration procedures.

Select the EPSON RC+ menu-[Tools]-[Command Window].

This step is omitted in the calibration procedures.

### Jog Motion

Setting of the jog motion is required in some calibration procedures.

Select EPSON RC+ menu-[Tools]-[Robot Manager] and select the [Jog & Teach] page.

The panel, window, and page above are indicated as [Jog & Teach] in the calibration procedures.

Follow steps 1 to 6 to calibrate the Manipulator.

#### 1. Basic Pose Confirmation

Pose data (Point data) prior to the part replacement (motors, reduction gear unit, or belt) is necessary for the calibration.

Verify the recorded pulse values of the basic pose obtained in the *Setup & Operation 3.7 Checking the Basic orientation.*

#### 2. Part Replacement

Replace parts as instructed in this manual.

Be careful not to injure yourself or damage parts during part replacement.

#### 3. Encoder Initialization

Turn ON the Controller while all joints are in the motion range.

The error message “Encoder alarm has occurred. Check robot battery. EPSON RC+ must be restarted.” will be displayed.

Initialize the encoder at the current position and reset the error.

Initialize the encoder using one of the following procedures.

Execute the following command at the [Monitor Window].

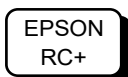

>Encreset [The joint number (1 to 6) of the encoder to be reset]

Select EPSON RC+ menu-[Tools]-[Controller], then click <Reset Controller>.

After resetting the error, the motor encoder of the joint whose parts have been replaced will be initialized.

Set the jog mode to “Joint” in [Jog & Teach] and operate the Manipulator in jog motion to match the home position marks (0 pulse position) of the joint accurately.

When the joint cannot move to the home position, operate the Manipulator to match the tram mark placed in *Setup & Operation 3.7 Checking the Basic Orientation* as accurate as possible.

Initialize the encoder when the joint matches the home position or the tram mark.

For the encoder initialization, refer to the procedure indicated above.



When the origin of the Joint #5 is calibrated, the Joint #6 will be out of position. (Due to the structure of the Manipulator, any offset in the position of the Joint #5 affects the Joint #6.)

Calibrate the origin of the Joint #6 together when calibrating the Joint #5.

#### 4. Calibration

Calibration marks of each joint

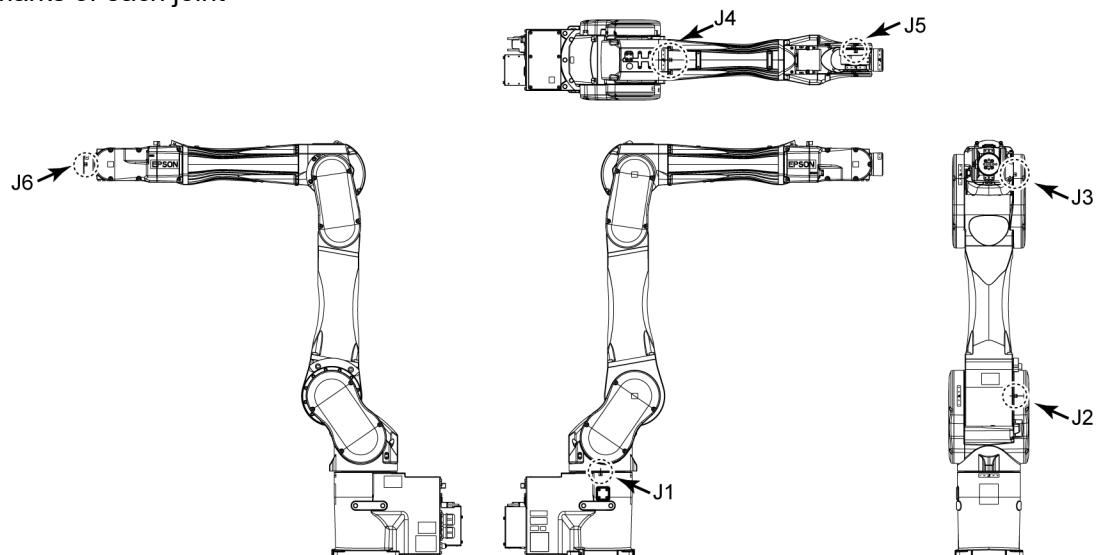

(Figure: C8-A1401\*\* (C8XL))

4-1 Move the arm you want to calibrate to the position of the calibration mark.

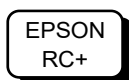

Select menu-[Tool]-[Robot Manager]-[Jog & Teach] panel to move the Manipulator.

If an error occurs after replacing the motor and you cannot use the [Jog & Teach] panel or “Brake OFF, \*” does not work (\* is an axis number to calibrate.), go through the steps (4) and (5) now.

Then, [Jog & Teach] panel and “Brake OFF, \*” will be available. Move the arm you want to calibrate to the position of the calibration mark.

#### 4-2 Reset the encoder.



Execute one of the following commands to reset the encoder of the joint you want to calibrate from the menu-[Tool]-[Command Window].

```
Joint #1 >Encreset 1  
Joint #2 >Encreset 2  
Joint #3 >Encreset 3  
Joint #4 >Encreset 4  
Joint #5 >Encreset 5, 6  
Joint #6 >Encreset 6
```

#### 4-3 Reboot the Controller.

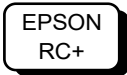

Click EPSON RC+ menu-[Tool]-[Controller]-<Reset Controller>.

#### 4-4 Input the command in the Command window and execute it.



Execute one of the following commands to reset the encoder of the joint you want to calibrate from the menu-[Tool]-[Command Window].

```
>calpls 0,0,0,0,0,0  
* Manipulator does not move.
```

#### 4-5 Perform the calibration.



Execute one of the following commands to reset the encoder of the joint you want to calibrate from the menu-[Tool]-[Command Window].

```
Joint #1 >calib 1  
Joint #2 >calib 2  
Joint #3 >calib 3  
Joint #4 >calib 4  
Joint #5 >calib 5,6  
Joint #6 >calib 6
```

Move the arm to several points to check if the arm moves to the original positions properly.

Teach points if fine adjustment is necessary.



## 5. Calibration (More accurate positioning)

EPSON  
RC+

Move the Manipulator to the selected point data by jogging in [Jog & Teach].

Move the joint\* which is not calibrated to the specified point by motion command.

\*When the Joint #5 is being calibrated, move the Joints #1 - #4 to the home positions.

For example, when the selected point data is “P1”, execute “Motor On” in [Control Panel] and execute “Go P1” in [Jog & Teach].

Position the calibrating joint\* to the selected point data position accurately by jog command.

\* When the Joint #5 is being calibrated, move the Joint #5 and #6 to the home positions.

Select the “Joint” jog mode from [Jog & Teach] to operate in the jog motion.

Enter the command below in the command window and execute it.

Execute the command below in the menu -[Tools]-[Command Window].

```
>calpls ppls(P1,1), ppls(P1,2), ppls(P1,3), ppls(P1,4),  
ppls(P1,5), ppls(P1,6)
```

\*The Manipulator will not move.

Perform the calibration. Input one of the following commands according to the joint being calibrated.

```
Joint #1 : >calib 1  
Joint #2 : >calib 2  
Joint #3 : >calib 3  
Joint #4 : >calib 4  
Joint #5 : >calib 5,6  
Joint #6 : >calib 6
```

## 6. Accuracy Testing

Move the Manipulator to a different pose (point) to verify whether it moves back to the original position. If accuracy is inadequate, it is necessary to re-calibrate the origin using a different pose (point). You must set the pose (point) again if the Manipulator does not move back to the original position after re-calibration.

## 17. Maintenance Parts List

Name		Code	Note	Reference in <i>Maintenance</i>	Overhaul **		
AC servo motor	Joint #1 unit	C8, C8L	2172921	1000 W, unit	5.1.1, 5.2.1	✓	
		C8XL	2172922			✓	
	Joint #2	2168683	750 W, single item	6.1	✓		
	Joint #3	2168684	400 W, single item	7.1	✓		
	Joints #4, 5, 6	2172051	100 W, single item	8.1, 9.1, 10.1	✓		
Reduction gear unit*	Joint #1	C8	1674602	Unit For standard /Clean-room models	5.1.2, 5.2.2	✓	
		C8L	1674603			✓	
		C8XL	1674604			✓	
	Joint #2	C8, C8L	1674605		6.2	✓	
		C8XL	1674606		✓		
	Joint #3	C8, C8L	1674607		7.2	✓	
		C8XL	1674608		✓		
	Joint #4	C8, C8XL	1674609		8.2	✓	
		C8L	1675434		✓		
	Joints #5, 6	1674610	9.2, 10.2		✓		
Electromagnetic brake	Joints #1, 2	2172926	A set of brake and power supply	5.1.4, 5.2.4, 6.4	✓		
	Joint #3	2172927		7,4	✓		
	Joints #4, 5, 6	2172928		8.4, 9.4, 10.4	✓		
J1 brake positioning jig		1675081	Assembly tool	5.1.4, 5.2.4			
Timing belt	Joint #1	C8	1655928	Width 20 mm	560mm	5.1.3, 5.2.3	✓
		C8L	1655929		580mm		✓
		C8XL	1655930		595 mm		✓
	Joint #2	C8	1655920	Width 14 mm	475mm	6.3	✓
		C8L	1655924		485mm		✓
		C8XL	1655927		540 mm		✓
	Joint #3	C8	1655915	Width 10 mm	471 mm	7.3	✓
		C8L	1655918		480 mm		✓
		C8XL	1655919		501 mm		✓
	Joint #4	1655931	Width 6 mm	243 mm	8.3	✓	
	Joint #5	1655932		330 mm	9.3	✓	
	Joint #6	1655933		339 mm	10.3	✓	
	Belt tensile jig		1674582	Assembly tool	5, 6, 7, 8, 9, 10		
Battery unit		2172925	(2 lithium batteries for replacement)	11.1			
Battery board		2173216		11.2			

### \*\* Overhaul

As a rough indication, perform the overhaul (parts replacement) before reaching 20,000 operation hours of the Manipulator. The operation hours can be checked in [Controller Status Viewer] dialog - [Motor On Hours]. For details, refer to *Maintenance 2.2 Overhaul*.

\* Reduction Gear Unit: A reduction gear unit consists of the following three parts. When replacing the reduction gear unit, be sure to replace these parts all together as a set.

**Waveform generator**

The waveform generator consists of an ellipsoidal cam and ball bearings on outer circumference. The inner ring of the bearings is secured to the cam, while the outer ring is capable of flexible deformation through the ball bearings.

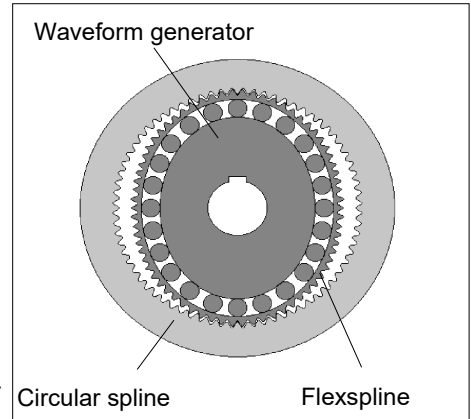

**Flexspline**

A thin, elastic, hat-shaped metal body with gear teeth around the outer circumference of the opening.

**Circular spline**

A rigid, ring-shaped body with gear teeth on the inner circumference.

The circular spline has two more teeth than the flexspline does.

The splines are greased. Be sure to keep the grease from being attaching to the clothes.

Name		Code	Note	Reference in Maintenance
Grease **	Joints #1, #2, #3, #4, #5 : SK-1A	-	For purchasing grease, liquid gasket, and adhesive, please contact the supplier of your region.	2.3, 5.1.2, 5.2.2, 7.2, 8.2, 9.2
	Joint #6, Bevel gear : SK-2	-		2.3, 10.2
	Cable : GPL-224	-		4
Liquid gasket **	For protection model : 1207B	-		3
Adhesive	LOCTITE641	-		8.2, 9.2
Grease-up kit		1674592	Set of grease gun, nipple, an extension tool	2.3
Grease plug		1656158		2.3

\*\* Regarding purchase of grease, liquid gasket and adhesive

Due to the chemicals regulations of individual countries (the UN GHS), we are requesting our customers to purchase grease and other materials required for maintenance from the manufacturers listed in the table below as of April 2015.

Regarding purchase of grease and other materials, please contact the following manufacturers. If there is anything unclear, please contact the supplier of your region.

Product name	Manufacturer	URL
Harmonic Grease SK-1A Harmonic Grease SK-2	Harmonic Drive Systems Inc.	<a href="http://www.harmonicdrive.net/">http://www.harmonicdrive.net/</a>
Krytox®GPL-224	DuPont	<a href="http://www2.dupont.com/Our_Company/en_US/worldwide/us_country.html">http://www2.dupont.com/Our_Company/en_US/worldwide/us_country.html</a>
1207B	ThreeBond Co.,Ltd	<a href="http://www.threebond.com">http://www.threebond.com</a>
LOCTITE641	LOCTITE	<a href="http://loctite.com/">http://loctite.com/</a>

Maintenance 17. Maintenance Parts List

Name		Code	Note	Reference in Maintenance	
Control board 1, 2	Arms #1, #3	2138032		12	
O ring	Joint #2	C8, C8L	1263978	Arm #1 side	6.2
			1656161	Arm #2 side	
		C8XL	1670635	Arm #1 side	
			1656140	Arm #2 side	
	Joint #3		1263977	Arm #2 side	7.2
			1510528	Arm #3 side	
	Joint #4		1263976	Arm #3 side	8.2
			1520370	Arm #4 side	
Grease inlet		1657289	Base, Arm #5	2.3, 11	
LED lamp		1668127	Standard/Clean-room model	13	
M/C cable	3 m	Straight	R12NZ900S1	14	
		L-shaped	R12NZ900S5		
	5 m	Straight	R12NZ900S2		
		L-shaped	R12NZ900S6		
	10 m	Straight	R12NZ900S3		
		L-shaped	R12NZ900S7		
	15 m	Straight	R12NZ900YC		
		L-shaped	R12NZ900YB		
	20 m	Straight	R12NZ900S4		
		L-shaped	R12NZ900S8		
M/C cable (flexible)	3 m	Straight	R12NZ900S9	14	
		L-shaped	R12NZ900SD		
	5 m	Straight	R12NZ900SA		
		L-shaped	R12NZ900SE		
	10 m	Straight	R12NZ900SB		
		L-shaped	R12NZ900SF		
	15 m	Straight	R12NZ900YE		
		L-shaped	R12NZ900YD		
	20 m	Straight	R12NZ900SC		
		L-shaped	R12NZ900SG		
Cable unit	C8		2172929	Standard/Clean-room model	4
			2172932	Protection model	
	C8L		2172930	Standard/Clean-room model	
			2172933	Protection model	
	C8XL		2172931	Standard/Clean-room model	
			2172934	Protection model	
Wire tie	AB100	1675753	1 bag (100 pcs: white)	4	
	AB150	1675754	1 bag (100 pcs: white)	5.1, 5.2	
	AB350	1697428	1 bag (50 pcs: white)		
Felt sheet	For Arm #3	1673981	Square	8	
	For Arm #3 maintenance cover	1673980	Square	8	
	For Joint #4	1673979	Round	8	
	For Joint #5	1673978	Round	9	
Fan (C8XL only)			2177465	Standard/Clean-room model	15
			2178399	Protection model	
Heat radiation sheet	For heat radiation block	1694609		5.1, 5.2	
	For Motor	1655043	Joint #1, 2 common	5.1, 5.2, 6.2	

Name		Code	Note	Reference in <i>Maintenance</i>	
Cover	Arm #1	Center cover	1675435	Metal cover Common to Standard/ Clean-room models	3
		Side cover	1674537		
	Arm #2	Side cover (left)	1655114	Standard model Plastic cover	3
		Side cover (right)	1674542		
	Arm #3	Cover	1674543		
	Arm #4	Side cover	1674547		
	Arm #1	Side cover	1674548	Clean-room model Plating cover	3
		Side cover (left)	1655127		
		Side cover (right)	1674550		
		Arm #3	Cover		
Arm #4		Side cover	1674553		
Gasket	Arm #1	Center gasket	1665238	Protection model	3
		Side gasket	1665240		
	Arm #2	Side gasket	1665241		
		Arm #3	Cover gasket		
	Maintenance gasket		1665254		
	Arm #4	Side gasket	1665243		
		Maintenance gasket	1665257		
		D-sub attachment gasket	1665255		
		Base	Rear gasket		
	Bottom gasket		1665247		
	Maintenance gasket		1665248		
	Sub plate gasket		1665246		
	Installation gasket		1668377		
	Gasket For Heat sink	1694610	Clean-room model Protection model	3	
Seal washer	M4 (for sub plate)	1665882	Protection model	3	
Air plug	For M6	1657011		4	

## 18. Option Parts List

Name		Code	Note	Reference in <i>Setup &amp; Operation</i>
Brake release unit (with cable and M/C short connector)		R12NZ900N4	For Europe (200V)	6.1
		R12NZ900N5	For U.S. & Japan (100V)	
	MC short connector	R12NZ900N7	For brake release unit	
Camera plate unit		R12B031922	Common to C3 and C4 (R12NZ9003F)	6.2
Tool adapter (ISO flange)		R12NZ900LQ		6.3
Adjustable mechanical stop	J1	R12NZ900LR		6.4
	C8/C8L J2	R12NZ900N6		
	C8XL J2	R12NZ900LT		
	J3	R12NZ900LU		
Fittings for customer use	ø6 straight	R12NZ900LV		6.5
	ø6 elbow	R12NZ900LW		
Standard user connector kit	D-sub	R12NZ900LX		
Waterproof user connector kit	D-sub	R12NZ900LY		
	Ethernet	R12NZ900LZ		